

HONEYWELL

See full Datasheet below...

onlinecomponents.com
THE ONLINE DISTRIBUTOR OF ELECTRONIC COMPONENTS

BUY NOW

 **MASTER**TM
ELECTRONICS

BUY NOW

masterelectronics.com & onlinecomponents.com
are **authorized** e-commerce distributors
of electronic components.



MICRO SWITCH™ Sealed
Subminiature Basic Switches
ZD Series



MICRO SWITCH™ ZD Series

Sealed Subminiature Basic Switches

Honeywell's MICRO SWITCH™ ZD Series is a sealed subminiature snap action switch. Although small in size, the ZD Series is rated for controlling electrical loads ranging from logic-level (low current, low voltage) to limited power-duty switching (up to 3 A/125 Vac).

The switch when provided with integral wire leads is sealed to IP67 and is suitable for applications where the switch assembly would be exposed to liquids or particulate contaminants in the environment.

A wide variety of stainless steel levers are available, and when combined with the subminiature package size, can adapt the switch for many different applications. The ZD Series is certified to UL, cUL, ENEC, and CQC for worldwide use.

What makes our switches better?

- The IP67-rated sealed switch is designed to operate in a variety of demanding applications, reducing the challenge of harsh environments
- Current carrying capacity, up to 3 A, allows for a solution in many applications where space is a premium
- Switch package designed to accommodate demanding temperature requirements, up to 85 °C [185 °F]



Available for worldwide applications.

RIGHT SWITCH FOR THE RIGHT APPLICATION
HARSH ENVIRONMENTS • RELIABILITY • ELECTRICAL RATING

Features and Benefits

SMALL PACKAGE SIZE

Subminiature package size allows the MICRO SWITCH™ ZD Series switch to fit in applications where other sensors or switches are too large.

IP67 sealing: pre-wired switches

WELL SUITED FOR POWER-DUTY AND LOGIC-LEVEL LOADS

SPDT, SPNC, or SPNO switch options help assure the circuit requirements are met. The ZD Series can control limited **power-duty switching** with silver contacts or **logic-level** (low voltage, and milliamperes) with gold-plated contacts.

PERFORMS IN WET, DIRTY, AND DUSTY ENVIRONMENTS

Catalog listings with pre-leaded wires are sealed to IP67 **for use in environments where exposure to liquid ingress or particulate contaminant could occur.**

DESIGN FLEXIBILITY

Switches are built with an **integral sealed pin plunger**. Various styles of levers expand the versatility of the ZD Series in the application. In addition, the ZD Series features a **variety of terminations** to promote flexibility for the electrical connectivity.

SIMPLIFIED INSTALLATION

Integral mounting pins (pillars) on the switch housing simplify and reduce installation time.

Potential Applications















TRANSPORTATION

- Electric window control for automobiles
- Automobile seat belt latch detection
- Engine hood or trunk latch detection
- Vehicle door latch detection
- Vehicle mounted wheelchair lifts



ZD Series

PRODUCT NOMENCLATURE

ZD	20	S	10	A	0	3	0	0	—
Switch Type	Current Rating	Operating Force ³ (at pin plunger)	Terminal Type	Actuator Type	Circuitry	Pillar & Travel ⁹	Wire Size	Wire Type ⁵	Special Designator
ZD Series Subminiature	20 10 mA, 12 Vdc	S 130 g max.	Wired (blank) ⁴	A Pin plunger	0 SPDT	1 No pillar, short travel 	Terminal option (blank)	Terminal option (blank)	<p>A special designator is used to indicate non-standard feature, such as a special actuator, wire color, wire length, connector, etc. This code will consist of three alphanumeric characters.</p> <p>R: indicates wire exit opposite plunger</p> <p>L: indicates wire exit plunger end</p>
Basic Switch	30 3 A 12 Vdc 3 A 125 Vac		10 Solder (2.5 mm x 1.70 mm)	B Special formed lever, 13.7 mm	3 SPNO ⁵	2 Left pillar, short travel 	E 20 AWG (standard)	A UL1007 (standard)	
			20 PCB, straight (0.6 mm x 2.5 mm)	C Straight lever, 15 mm	4 SPNC ⁵	3 Right pillar, short travel 	F 22 AWG	C UL1430	
			50 PCB, right angle	H Sim. roller lever, 18.6 mm		4 No pillar, long travel 	G 24 AWG	D UL1061	
			60 PCB, left angle	J Long straight lever, 23 mm		5 Left pillar, long travel 	H 26 AWG	F AVSS ⁸ (automotive)	
			70 Long solder ⁷	K Sim. roller lever, 14.4 mm		6 Right pillar, long travel 			
			99 SPECIAL ²	M Special formed lever, 15 mm		7 No pillar, w/ mntng hole tab, long travel 			
				N Sim. roller lever, 17 mm		8 No pillar, w/ mntng hole tab, short travel 			
				S SPECIAL ²		9 Short pillar & mntng hole long travel 			
						10 Short pillar & mntng hole short travel 			
						11 Left & right pillar short travel 			
						12 Left & right pillar long travel 			
						99 SPECIAL ²			

NOTES:

- ¹ Not all combinations of model code are available. Please contact your Honeywell provider/representative for assistance.
- ² Terminal Type "99", Actuator Type "S", and/or Pillar/Travel Type "99" designates a special and requires a special designation at the end of the listing.
- ³ Operate force is measured at the plunger. Adding an actuator/lever will change the operate force. See page 6 for operate force.
- ⁴ Standard wire exit is out the bottom of the switch. No special designator is necessary for this wire exit direction.
- ⁵ SPNO and SPNC are only available if termination type is wired.
- ⁶ Standard wire length is 500 mm [19.5 in] long. Other lengths available upon request.
- ⁷ Long solder terminals do not have UL or ENEC approvals.
- ⁸ Switches with AVSS wire do not have UL approvals.
- ⁹ Long and short travel pertain to plunger travel distance. Short travel has a taller boss around the plunger to limit overtravel.

MICRO SWITCH™ Sealed Subminiature Basic Switches

Table 1. Specifications

Characteristic	ZD20S Series (Logic Level)	ZD30S Series (Power Duty)
Circuitry	SPDT, SPNC, SPNO <i>(Note: SPNC and SPNO prewired only)</i>	SPDT, SPNC, SPNO <i>(Note: SPNC and SPNO prewired only)</i>
Operating force	130 g max. @ plunger	130 g max. @ plunger
Termination	PCB, solder, prewired	PCB, solder, prewired
Sealing	IP67 (prewired), IP00 for exposed terminals	IP67 (prewired), IP00 for exposed terminals
Actuators (levers 300 series stainless steel)	pin plunger, flat lever, formed lever, simulated roller lever, special lever	pin plunger, flat lever, formed lever, simulated roller lever, special lever
Agency certification	UL, cUL, ENEC, CQC, RoHS compliant	UL, cUL, ENEC, CQC, RoHS compliant
Operating temperature (manufacturer rated)	-40 °C to 85 °C [-40 °F to 185 °F]	-40 °C to 85 °C [-40 °F to 185 °F]
Mechanical endurance (cycles)	500,000 min. @ 120 cycles per min. max.	500,000 min. @ 120 cycles per min. max.
Electrical endurance (cycles)	Up to 500,000 @ 30 cycles/minute max.	Up to 100,000 @ 30 cycles/minute max.
Switch resistance (initial)	100 mΩ max.	100 mΩ max.
Insulation resistance (initial)	100 MΩ min. (500 Vdc for one minute)	100 MΩ min. (500 Vdc for one minute)
Dielectric strength (initial) <i>(between live parts and ground)</i>	500 VRMS for one minute ≤ 0.5 mA leakage current	500 VRMS for one minute ≤ 0.5 mA leakage current
Plunger seal	silicone	silicone
Contact material	gold-plated silver	silver
Housing material	case, polyamide (nylon); cover, PBT polyester	case, polyamide (nylon); cover, PBT polyester

Note: Refer to engineering drawing for additional information.

Table 2. Electrical Ratings

Switch option	CQC (Asia-Pacific) Per GB 15092-1	ENEC (Europe) Per IEC 61058-1	UL, cUL (Americas) UL 1054, File 12252
ZD20S Series (Gold-plated contacts)	0.01 A, 12 Vdc, 500,000 cycles	0.01 A to 0.1 A, 12 Vdc 100,000 cycles	0.01 A to 0.1 A, 12 Vdc 10,000 cycles
ZD30S Series (Silver contacts)	3 A, 12 Vdc, 100,000 cycles 3 A, 125 Vac, 10,000 cycle	3 A, 12 Vdc, 100,000 cycles 3 A, 125 Vac, 10,000 cycles	3 A, 12 Vdc, 100,000 cycles 3 A 125 Vac, 6000 cycles

Note: UL, cUL “use temperature”; 0 °C to 65 °C [32 °F to 149 °F]; CQC and ENEC “use temperature”; 0 °C to 55 °C [32 °F to 131 °F].

ZD Series

PRODUCT SPECIFICATIONS AND LISTINGS

Contact your Honeywell rep or distributor for additional listings

O.F. • Operating force
 R.F. • Release force
 P.T. • Pretravel
 O.T. • Overtravel
 D.T. • Differential travel
 O.P. • Operating position

	Catalog Listing	Actuator	Circuitry/ Contact Material	Elect. Rating Spec. (page 4)	Termination	Operate Force max. N [Gm]	Release Force min. N [Gm]	Free Position max. mm [in] No hole or pillar, from top of switch (see page 8)	
	ZD20S10A01	Pin plunger	SPDT/ Gold Plated	0.1 A	Solder	1,27 [130]	0,34 [35]	3,65 [0.14]	
	ZD20S10A02	Pin plunger	SPDT/ Gold Plated	0.1 A	Solder	1,27 [130]	0,34 [35]	–	
	ZD20S20A01	Pin plunger	SPDT/ Gold Plated	0.1 A	PCB	1,27 [130]	0,34 [35]	–	
	ZD20S20A02	Pin plunger	SPDT/ Gold Plated	0.1 A	PCB	1,27 [130]	0,34 [35]	–	
	ZD20S20A03	Pin plunger	SPDT/ Gold Plated	0.1 A	PCB	1,27 [130]	0,34 [35]	–	
	ZD20S20A04	Pin plunger	SPDT/ Gold Plated	0.1 A	PCB	1,27 [130]	0,34 [35]	–	
	ZD20S20A05	Pin plunger	SPDT/ Gold Plated	0.1 A	PCB	1,27 [130]	0,34 [35]	–	
	ZD20S20A06	Pin plunger	SPDT/ Gold Plated	0.1A	PCB	1,27 [130]	0,34 [35]	–	
	ZD20SA01EA	Pin plunger	SPDT/ Gold Plated	0.1 A	Wire leads, bottom exit, 500 mm	1,27 [130]	0,34 [35]	3,65 [0.14]	
	ZD20SA02EA	Pin plunger	SPDT/ Gold Plated	0.1 A	Wire leads, bottom exit, 500 mm	1,27 [130]	0,34 [35]	–	
	ZD30S10A01	Pin plunger	SPDT/ Silver	3 A	Solder	1,27 [130]	0,34 [35]	3,65 [0.14]	
	ZD30S10A02	Pin plunger	SPDT/ Silver	3 A	Solder	1,27 [130]	0,34 [35]	–	
	ZD30S20A01	Pin plunger	SPDT/ Silver	3 A	PCB	1,27 [130]	0,34 [35]	–	
	ZD30S20A02	Pin plunger	SPDT/ Silver	3 A	PCB	1,27 [130]	0,34 [35]	–	
	ZD30S20A03	Pin plunger	SPDT/ Silver	3 A	PCB	1,27 [130]	0,34 [35]	–	
	ZD30S20A04	Pin plunger	SPDT/ Silver	3 A	PCB	1,27 [130]	0,34 [35]	–	
	ZD30S20A05	Pin plunger	SPDT/ Silver	3 A	PCB	1,27 [130]	0,34 [35]	–	
	ZD30S20A06	Pin plunger	SPDT/ Silver	3 A	PCB	1,27 [130]	0,34 [35]	–	
	ZD30SA01EA	Pin plunger	SPDT/ Silver	3 A	Wire leads, bottom exit, 500 mm	1,27 [130]	0,34 [35]	3,65 [0.14]	
	ZD30SA02EA	Pin plunger	SPDT/ Silver	3 A	Wire leads, bottom exit, 500 mm	1,27 [130]	0,34 [35]	–	
	ZD20S20H02	Simulated roller leaf lever	SPDT/ Gold Plated	0.1 A	PCB	1,57 [160]	0,44 [45]	–	
	ZD30S60N05	Simulated roller leaf lever	SPDT/ Silver	3 A	PCB (left side)	1,96 [200]	0,49 [50]	–	
	ZD30S60C05	Straight leaf lever	SPDT/ Silver	3 A	PCB (left side)	1,91 [195]	0,54 [55]	–	
	ZD30SC02EA	Straight leaf lever	SPDT/ Silver	3 A	Wire leads, bottom exit, 500 mm	1,91 [195]	0,54 [55]	–	

MICRO SWITCH™ Sealed Subminiature Basic Switches

O.F. • Operating force
 R.F. • Release force
 P.T. • Pretravel
 O.T. • Overtravel
 D.T. • Differential travel
 O.P. • Operating position

	Free Position max. mm [in] from mounting hole or pillar (see page 8)	Free Position max. mm [in] from base for PCB terminal (see page 8)	Operate point mm [in] No hole or pillar, from top of switch (see page 8)	Operate point mm [in] from mounting hole or pillar (see page 8)	Operate point mm [in] from base for PCB terminals (see page 8)	P.T. max. mm [in]	O.T. min. mm [in]	D.T. max. mm [in]
	–	–	3,05 ±0,2 [0.12 ±0.008]	–	–	0,80 [0.03]	0,80 [0.03]	0,3 [0.01]
	7,35 [0.29]	–	–	6,75 ±0,2 [0.27 ±0.008]	–	0,80 [0.03]	0,80 [0.03]	0,3 [0.01]
	–	11,15 [0.44]	–	–	10,55 ±0,2 [0.42 ±0.008]	0,80 [0.03]	0,80 [0.03]	0,3 [0.01]
	7,35 [0.29]	11,15 [0.44]	–	6,75 ±0,2 [0.27 ±0.008]	10,55 ±0,2 [0.42 ±0.008]	0,80 [0.03]	0,80 [0.03]	0,3 [0.01]
	7,35 [0.29]	11,15 [0.44]	–	6,75 ±0,2 [0.27 ±0.008]	10,55 ±0,2 [0.42 ±0.008]	0,80 [0.03]	0,80 [0.03]	0,3 [0.01]
	–	11,15 [0.44]	–	–	10,55 ±0,2 [0.42 ±0.008]	0,80 [0.03]	0,80 [0.03]	0,3 [0.01]
	7,35 [0.29]	11,15 [0.44]	–	6,75 ±0,2 [0.27 ±0.008]	10,55 ±0,2 [0.42 ±0.008]	0,80 [0.03]	0,80 [0.03]	0,3 [0.01]
	7,35 [0.29]	11,15 [0.44]	–	6,75 ±0,2 [0.27 ±0.008]	10,55 ±0,2 [0.42 ±0.008]	0,80 [0.03]	0,80 [0.03]	0,3 [0.01]
	–	–	3,05 ±0,2 [0.12 ±0.008]	–	–	0,80 [0.03]	0,80 [0.03]	0,3 [0.01]
	7,35 [0.29]	–	–	6,75 ±0,2 [0.27 ±0.008]	–	0,80 [0.03]	0,80 [0.03]	0,3 [0.01]
	–	–	3,05 ±0,2 [0.12 ±0.008]	–	–	0,80 [0.03]	0,80 [0.03]	0,3 [0.01]
	7,35 [0.29]	–	–	6,75 ±0,2 [0.27 ±0.008]	–	0,80 [0.03]	0,80 [0.03]	0,3 [0.01]
	–	11,15 [0.44]	–	–	10,55 ±0,2 [0.42 ±0.008]	0,80 [0.03]	0,80 [0.03]	0,3 [0.01]
	7,35 [0.29]	11,15 [0.44]	–	6,75 ±0,2 [0.27 ±0.008]	10,55 ±0,2 [0.42 ±0.008]	0,80 [0.03]	0,80 [0.03]	0,3 [0.01]
	7,35 [0.29]	11,15 [0.44]	–	6,75 ±0,2 [0.27 ±0.008]	10,55 ±0,2 [0.42 ±0.008]	0,80 [0.03]	0,80 [0.03]	0,3 [0.01]
	–	11,15 [0.44]	–	–	10,55 ±0,2 [0.42 ±0.008]	0,80 [0.03]	0,80 [0.03]	0,3 [0.01]
	7,35 [0.29]	11,15 [0.44]	–	6,75 ±0,2 [0.27 ±0.008]	10,55 ±0,2 [0.42 ±0.008]	0,80 [0.03]	0,80 [0.03]	0,3 [0.01]
	7,35 [0.29]	11,15 [0.44]	–	6,75 ±0,2 [0.27 ±0.008]	10,55 ±0,2 [0.42 ±0.008]	0,80 [0.03]	0,80 [0.03]	0,3 [0.01]
	–	–	3,05 ±0,2 [0.12 ±0.008]	–	–	0,80 [0.03]	0,80 [0.03]	0,3 [0.01]
	7,35 [0.29]	–	–	6,75 ±0,2 [0.27 ±0.008]	–	0,80 [0.03]	0,80 [0.03]	0,3 [0.01]
	13,80 [0.53]	17,60 [0.69]	–	9,90 ±0,8 [0.39 ±0.03]	13,7 ±0,2 [0.54 ±0.008]	4,80 [0.19]	1,65 [0.06]	0,7 [0.03]
	14,40 [0.57]	18,20 [0.72]	–	17,70 ±0,70 [0.70 ±0.03]	21,50 ±0,70 [0.85 ±0.03]	4,40 [0.17]	1,45 [0.06]	0,5 [0.02]
	10,70 [0.42]	14,50 [0.57]	–	7,40 ±0,2 [0.29 ±0.01]	11,20 ±0,2 [0.44 ±0.01]	3,85 [0.15]	1,35 [0.05]	0,5 [0.02]
	10,70 [0.42]	–	–	7,40 ±0,2 [0.29 ±0.01]	–	3,85 [0.15]	1,35 [0.05]	0,5 [0.02]

ZD Series

MOUNTING DIMENSIONS

PACKAGE DIMENSIONS

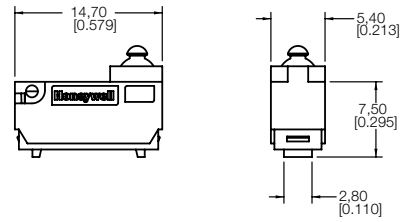

TRAVEL OPTIONS

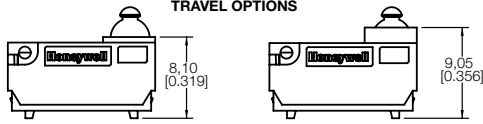

LONG TRAVEL

SHORT TRAVEL

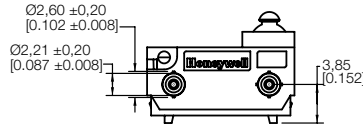
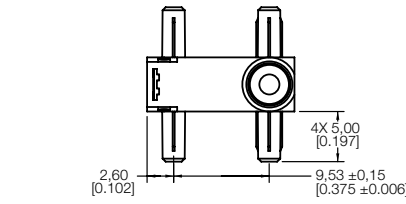

STANDARD PILLAR DIMENSIONS FOR ALL TYPES OTHER THAN 9 AND 10 (OTHER PILLAR DIAMETERS AND LENGTHS AVAILABLE UPON REQUEST)

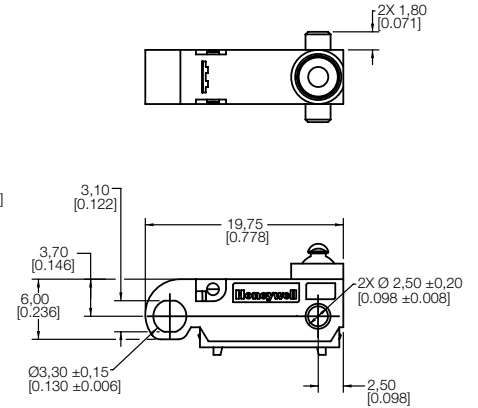

PILLAR OPTION 9 AND 10

TYPE 10

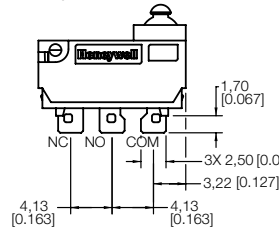

TYPE 50

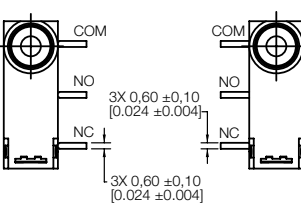

TYPE 60

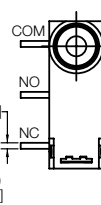

STRAIGHT

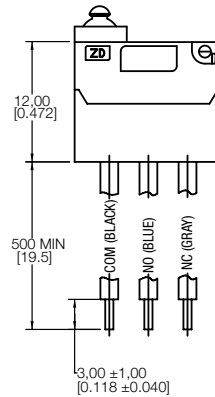

RIGHT

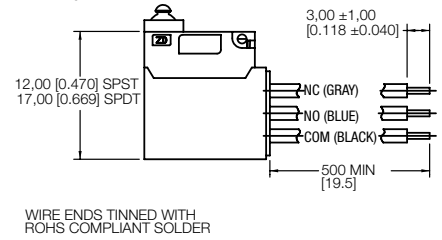

WIRE ENDS TINNED WITH ROHS COMPLIANT SOLDER

LEFT

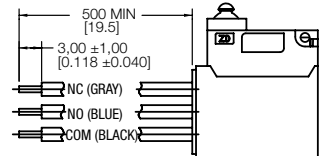

TYPE 20

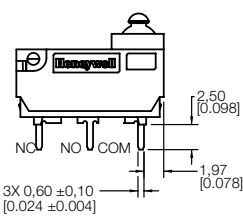

TYPE 70

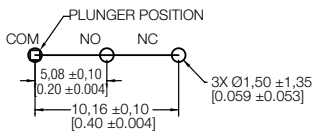
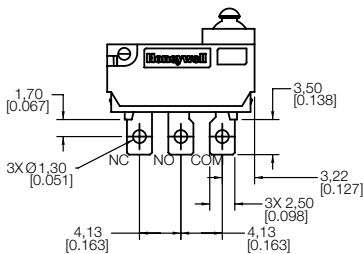

THRU HOLE SIZE RECOMMENDATIONS AND SPACINGS FOR PCB TERMINALS

Unless otherwise specified, a tolerance of ± 0.4 mm [0.02 in] applies to all dimensions.

All terminals are 0.5 mm ± 0.05 mm [0.02 in ± 0.002 in] thick.

ACTUATOR TYPES

TYPE A

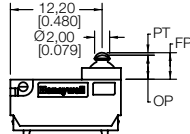

DATUM REFERENCE IS TOP OF SWITCH IF NO PILLARS OR NO PCB TERMINALS

TYPE B

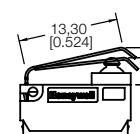

TYPE C

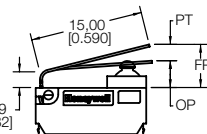

TYPE H

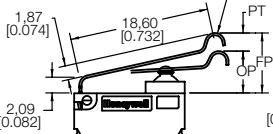

TYPE J

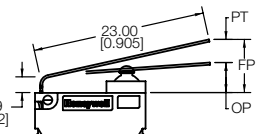

TYPE A

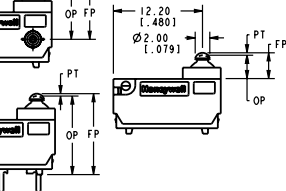

DATUM REFERENCE IS PILLAR OR MOUNTING HOLE (IF AVAILABLE)

DATUM REFERENCE IS BASE OF SWITCH FOR PCB TERMINALS

TYPE K

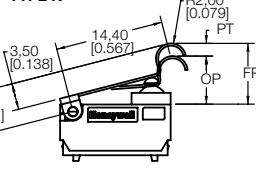

TYPE M

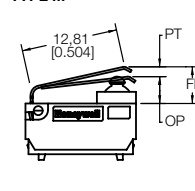

TYPE N

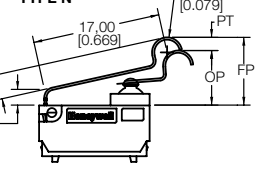

MICRO SWITCH™ Sealed Subminiature Basic Switches

This Honeywell datasheet supports the following MICRO SWITCH™ ZD Series Basic Switch Listings

ZD20S10A01	ZD20S20A05	ZD30S10A02	ZD30S20A06
ZD20S10A02	ZD20S20A06	ZD30S20A01	ZD30SA01EA
ZD20S20A01	ZD20S20H02	ZD30S20A02	ZD30SA02EA
ZD20S20A02	ZD20SA01EA	ZD30S20A03	ZD30S60C05
ZD20S20A03	ZD20SA02EA	ZD30S20A04	ZD30S60N05
ZD20S20A04	ZD30S10A01	ZD30S20A05	ZD30SC02EA

ADDITIONAL INFORMATION

The following associated literature is available on the Honeywell web site at sensing.honeywell.com:

- Product installation instructions
- Product range guide
- Product nomenclature tree
- Product application-specific information
 - Application note: Sensors and switches for potential HVAC/R applications
 - Application note: Sensors and switches for potential medical applications
 - Application note: Watertight switches in transportation applications
 - Technical bulletin: Applying precision switches
 - Technical bulletin: Low energy switch guide

WARNING

PERSONAL INJURY

DO NOT USE these products as safety or emergency stop devices or in any other application where failure of the product could result in personal injury.

Failure to comply with these instructions could result in death or serious injury.

WARNING

MISUSE OF DOCUMENTATION

- The information presented in this product sheet is for reference only. Do not use this document as a product installation guide.
- Complete installation, operation, and maintenance information is provided in the instructions supplied with each product.

Failure to comply with these instructions could result in death or serious injury.

WARRANTY/REMEDY

Honeywell warrants goods of its manufacture as being free of defective materials and faulty workmanship. Honeywell's standard product warranty applies unless agreed to otherwise by Honeywell in writing; please refer to your order acknowledgement or consult your local sales office for specific warranty details. If warranted goods are returned to Honeywell during the period of coverage, Honeywell will repair or replace, at its option, without charge those items it finds defective. **The foregoing is buyer's sole remedy and is in lieu of all other warranties, expressed or implied, including those of merchantability and fitness for a particular purpose. In no event shall Honeywell be liable for consequential, special, or indirect damages.**

While we provide application assistance personally, through our literature and the Honeywell website, it is up to the customer to determine the suitability of the product in the application.

Specifications may change without notice. The information we supply is believed to be accurate and reliable as of this printing. However, we assume no responsibility for its use.

Find out more

Honeywell serves its customers through a worldwide network of sales offices, representatives and distributors. For application assistance, current specifications, pricing or name of the nearest Authorized Distributor, contact your local sales office.

To learn more about Honeywell's sensing and control products, call **+1-815-235-6847** or **1-800-537-6945**, visit **sensing.honeywell.com**, or e-mail inquiries to **info.sc@honeywell.com**

Sensing and Control
Honeywell
1985 Douglas Drive North
Golden Valley, MN 55422
honeywell.com

The Honeywell logo is displayed in a bold, red, sans-serif font.