

Features

- 3.2mmx1.6mm SMT LED,1.8mm THICKNESS.
- LOW POWER CONSUMPTION.
- WIDE VIEWING ANGLE.
- IDEAL FOR BACKLIGHT AND INDICATOR.
- VARIOUS COLORS AND LENS TYPES AVAILABLE.
- PACKAGE : 2000PCS / REEL.
- MOISTURE SENSITIVITY LEVEL : LEVEL 3.
- RoHS COMPLIANT.



Notes:

1. All dimensions are in millimeters (inches).
2. Tolerance is $\pm 0.2(0.008)$ " unless otherwise noted.
3. Specifications are subject to change without notice.

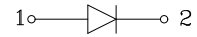
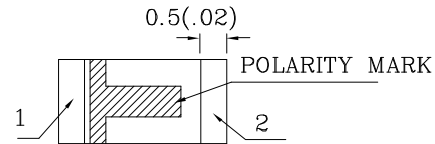
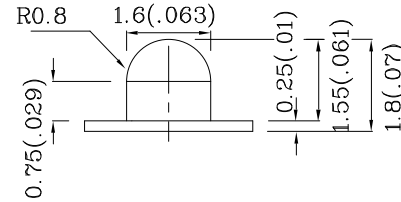
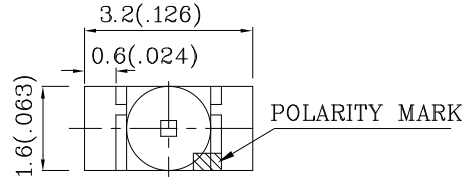

| Absolute Maximum Ratings (TA=25°C) | | UY (GaAsP/GaP) | Unit |
|----------------------------------------------------------------|------|-------------------|------|
| Reverse Voltage | VR | 5 | V |
| Forward Current | IF | 30 | mA |
| Forward Current (Peak) 1/10 Duty Cycle 0.1ms Pulse Width | iFS | 140 | mA |
| Power Dissipation | PT | 75 | mW |
| Operating Temperature | TA | -40 ~ +85 | °C |
| Storage Temperature | Tstg | -40 ~ +85 | |

| Operating Characteristics (TA=25°C) | | UY (GaAsP/GaP) | Unit |
|-----------------------------------------------------------------|-----|-------------------|------|
| Forward Voltage (Typ.) (IF=20mA) | VF | 2.1 | V |
| Forward Voltage (Max.) (IF=20mA) | VF | 2.5 | V |
| Reverse Current (Max.) (VR=5V) | IR | 10 | uA |
| Wavelength Of Peak Emission (Typ.) (IF=20mA) | λ P | 590 | nm |
| Wavelength Of Dominant Emission (Typ.) (IF=20mA) | λ D | 588 | nm |
| Spectral Line Full Width At Half-Maximum (Typ.) (IF=20mA) | Δλ | 35 | nm |
| Capacitance (Typ.) (VF=0V, f=1MHz) | C | 20 | pF |

| Part Number | Emitting Color | Emitting Material | Lens-color | Luminous Intensity (IF=20mA) mcd | | Wavelength nm λ P | Viewing Angle 2 θ 1/2 |
|----------------------------------------------------------------------------------------------------|----------------|-------------------|-------------|----------------------------------------|------|-------------------------|--------------------------|
| | | | | min. | typ. | | |
| XZUY55W-3 | Yellow | GaAsP/GaP | Water Clear | 4 | 29 | 590 | 40° |
| Published Date : JAN 21, 2008 Drawing No : XDSA1370 V6 Checked : B.L.LIU P.1/4 | | | | | | | |

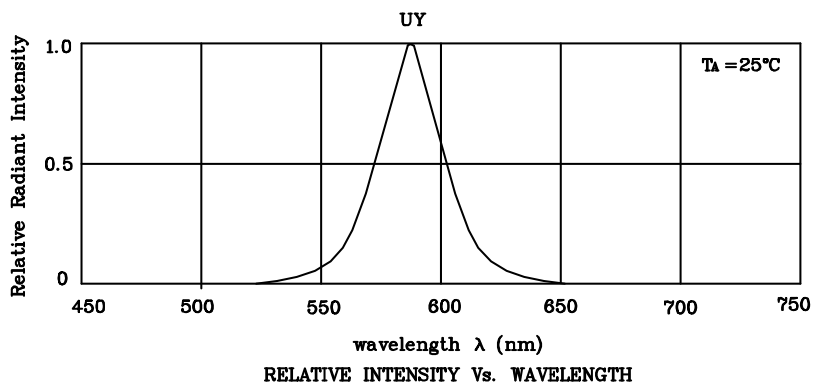

❖ **UY**

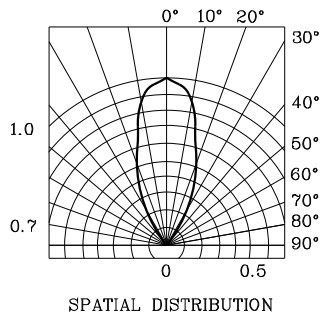
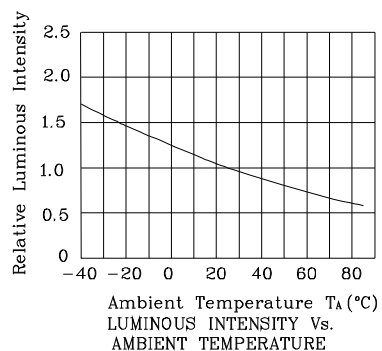
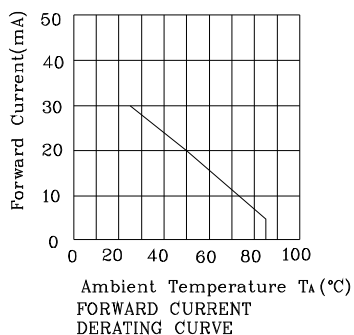
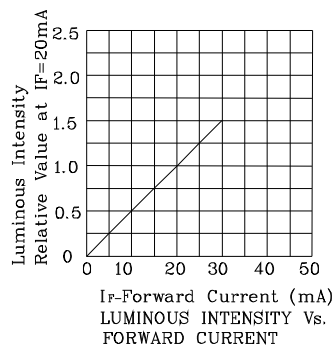
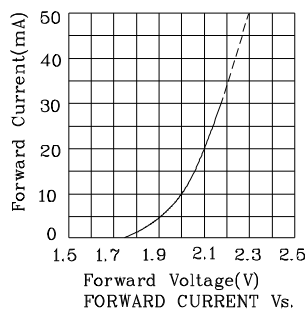

Reflow Soldering Profile For Lead-free SMT Process.

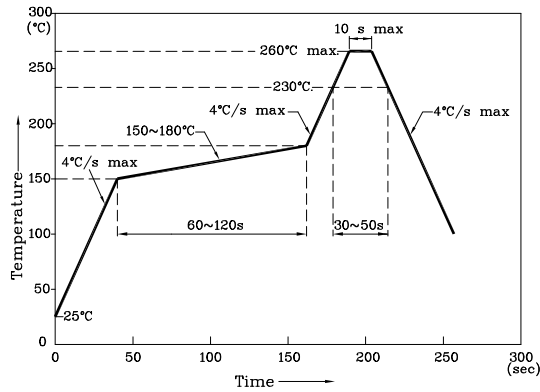

NOTES:

1. Maximum soldering temperature should not exceed 260°C.
2. Recommended reflow temperature: 145°C~260°C.
3. Do not put stress to the epoxy resin during high temperatures conditions.

❖ Recommended Soldering Pattern
(Units : mm; Tolerance: ±0.1)

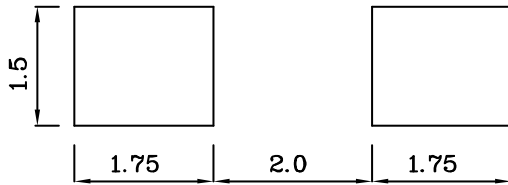

❖ The device has a single mounting surface. The device must be mounted according to the specifications.

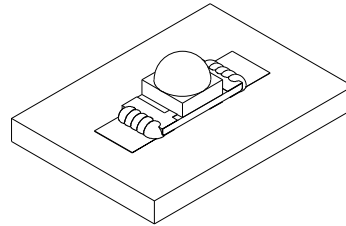

❖ Tape Specification (Units : mm)

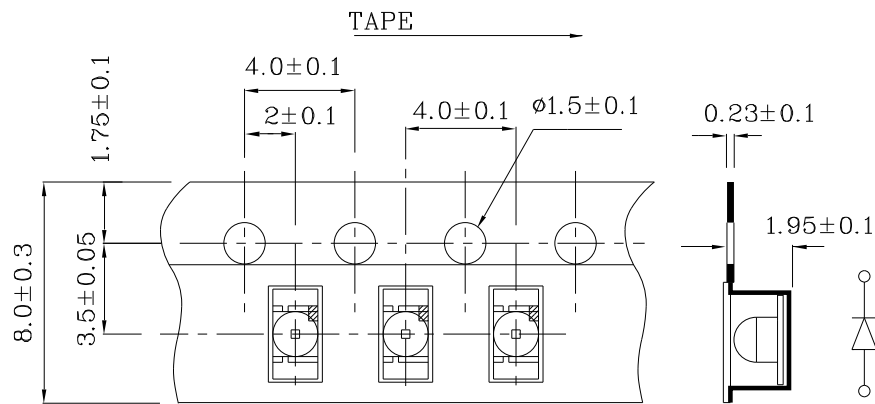

Remarks:

If special sorting is required (e.g. binning based on forward voltage, Luminous intensity / luminous flux, or wavelength), the typical accuracy of the sorting process is as follows:

1. Wavelength: +/-1nm
2. Luminous intensity / luminous flux: +/-15%
3. Forward Voltage: +/-0.1V

Note: Accuracy may depend on the sorting parameters.

PACKING & LABEL SPECIFICATIONS

XZUY55W-3

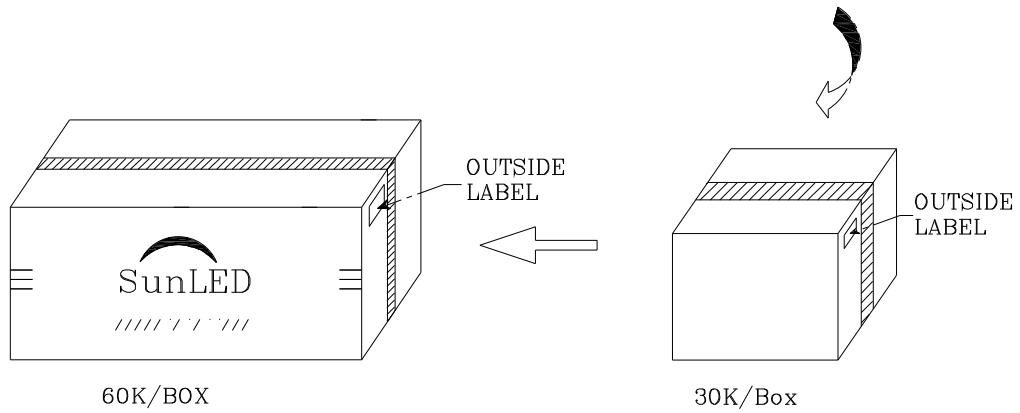
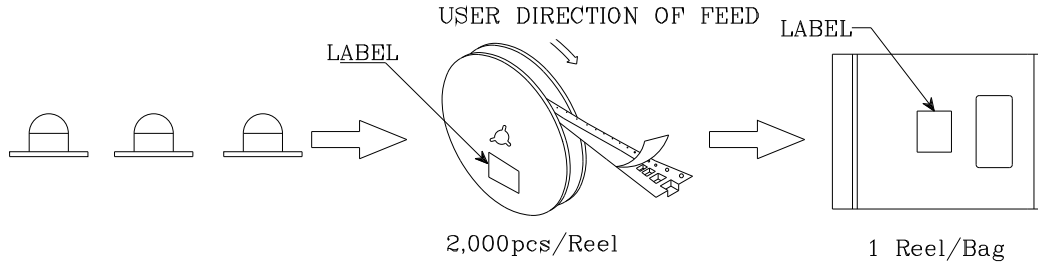

| | |
|------------------------------------------------------------------------------------------------------------------|-----------|
| P/NO : XZxxx55x-3 | |
| QTY : 2,000 pcs | CODE: XXX |
| S/N : XX | |
| LOT NO : | |
|  XXXXXXXXXXXXXXXXXXXXXXXX | |
| RoHS Compliant | |