

Features

- SOT-23 PACKAGE SURFACE MOUNT LED LAMP.
- LOW POWER CONSUMPTION.
- LONG LIFE - SOLID STATE RELIABILITY.
- PACKAGE: 2000PCS / REEL.
- MOISTURE SENSITIVITY LEVEL : LEVEL 3.
- RoHS COMPLIANT.

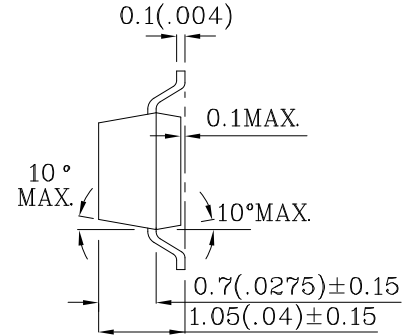
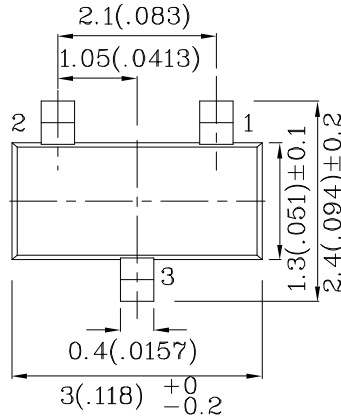

- 1 ANODE
- 2 N.C.
- 3 CATHODE

Notes:

1. All dimensions are in millimeters (inches).
2. Tolerance is $\pm 0.25(0.01")$ unless otherwise noted.
3. Specifications are subject to change without notice.

Absolute Maximum Ratings (TA=25°C)		UY (GaAsP/GaP)	Unit
Reverse Voltage	VR	5	V
Forward Current	IF	30	mA
Forward Current (Peak) 1/10 Duty Cycle 0.1ms Pulse Width	iFS	140	mA
Power Dissipation	PT	75	mW
Operating Temperature	TA	-40 ~ +85	°C
Storage Temperature	Tstg	-40 ~ +85	

Operating Characteristics (TA=25°C)		UY (GaAsP/GaP)	Unit
Forward Voltage (Typ.) (IF=20mA)	VF	2.1	V
Forward Voltage (Max.) (IF=20mA)	VF	2.5	V
Reverse Current (Max.) (VR=5V)	IR	10	uA
Wavelength Of Peak Emission (Typ.) (IF=20mA)	λ P	590	nm
Wavelength Of Dominant Emission (Typ.) (IF=20mA)	λ D	588	nm
Spectral Line Full Width At Half-Maximum (Typ.) (IF=20mA)	Δλ	35	nm
Capacitance (Typ.) (VF=0V, f=1MHz)	C	20	pF

Part Number	Emitting Color	Emitting Material	Lens-color	Luminous Intensity (IF=20mA) mcd		Wavelength nm λ P	Viewing Angle 2 θ 1/2
				min.	typ.		
XZUY48WA	Yellow	GaAsP/GaP	Water Clear	1.6	4.8	590	140°
Published Date : JAN 24,2008 Drawing No : XDSA1679 V6 Checked : B.L.LIU P.1/4							

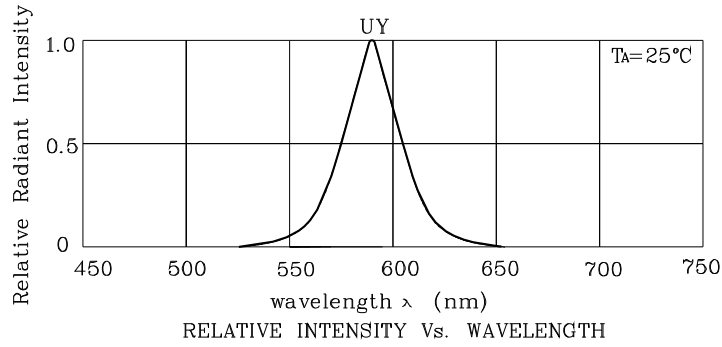

❖ UY

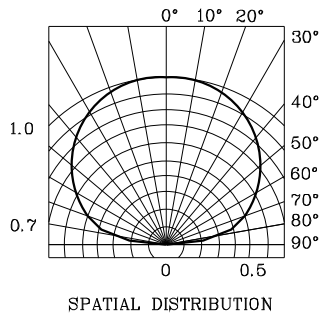
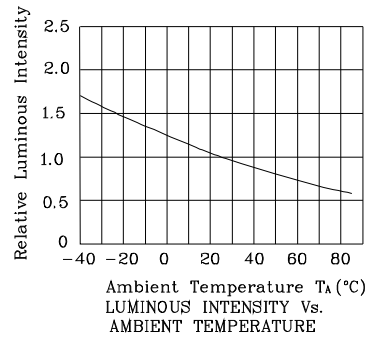
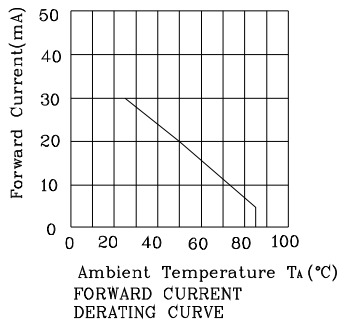
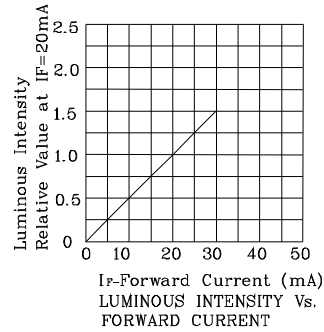
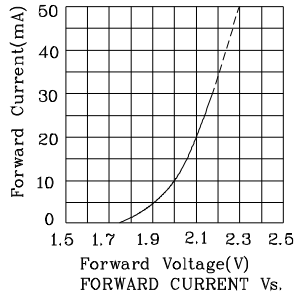

Reflow Soldering Profile For Lead-free SMT Process.

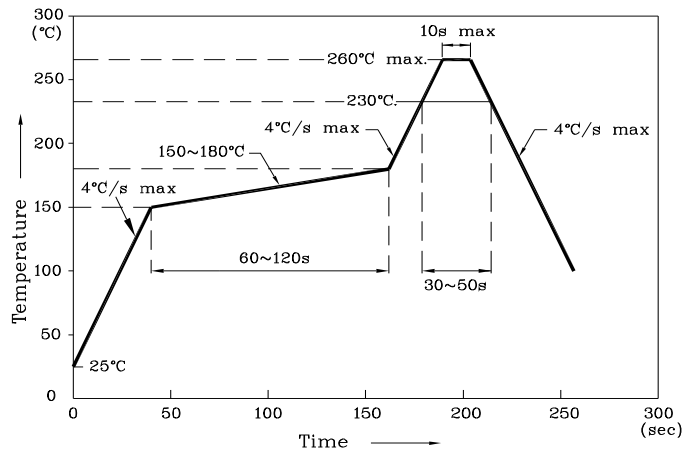

Notes:

1. Maximum soldering temperature should not exceed 260°C.
2. Recommended reflow temperature: 145°C-260°C.
3. Do not put stress to the epoxy resin during high temperatures conditions.

❖ Recommended Soldering Pattern (Units : mm; Tolerance: ± 0.1)

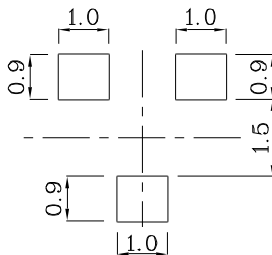

❖ The device has a single mounting surface. The device must be mounted according to the specifications.

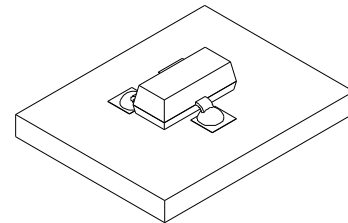

❖ Tape Specification (Units : mm)

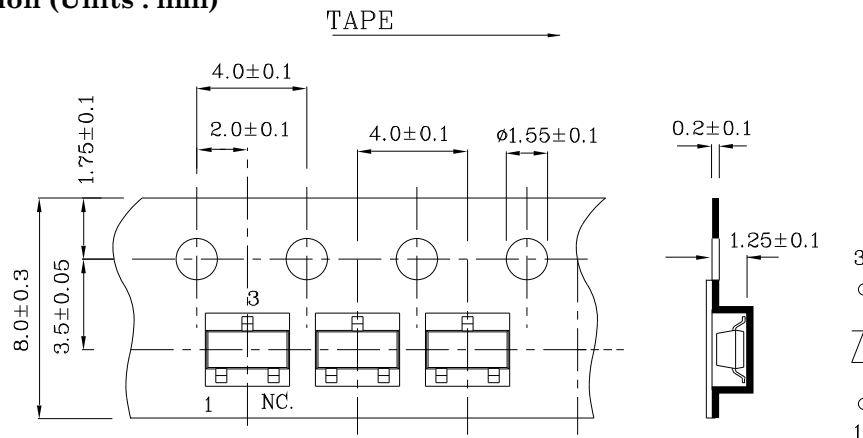

Remarks:



If special sorting is required (e.g. binning based on forward voltage, luminous intensity / luminous flux or wavelength), the typical accuracy of the sorting process is as follows:

1. Wavelength: +/-1nm
2. Luminous Intensity / luminous flux: +/-15%
3. Forward Voltage: +/-0.1V

Note: Accuracy may depend on the sorting parameters.

PACKING & LABEL SPECIFICATIONS

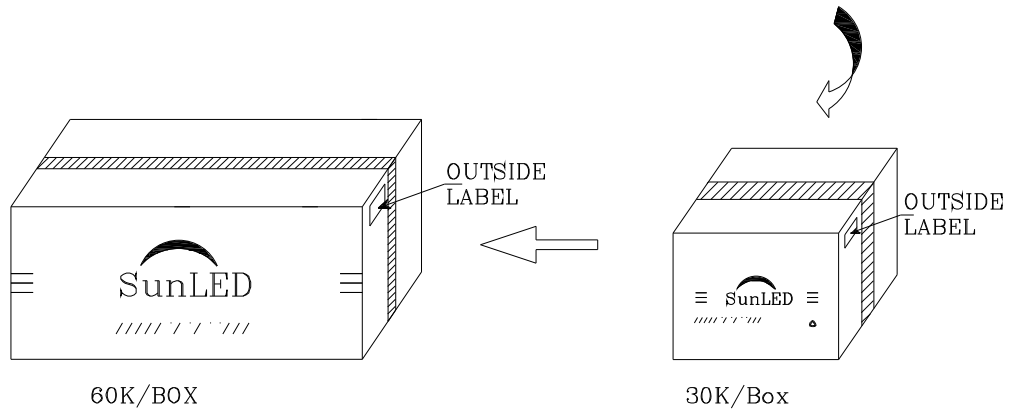
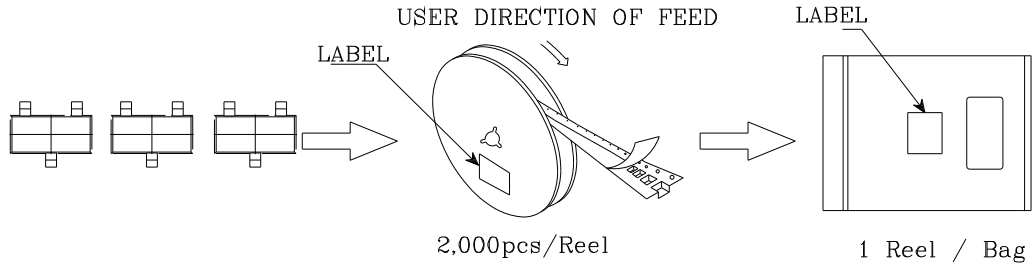
XZUY48WA

Q.C. Q C	
XX XX XXXX	
PASSED	
P/NO : XZxxx48x	
QTY : 2,000 pcs	CODE: XXX
S/N : XX	
LOT NO :	
 XXXXXXXXXXXXXXXXXXXXXXXXXXXX	
RoHS Compliant	