

**Features**

- 3.0mmx1.0mm RIGHT ANGLE SMT LED, 2.0mm THICKNESS.
- LOW POWER CONSUMPTION.
- WIDE VIEWING ANGLE.
- IDEAL FOR BACKLIGHT AND INDICATOR.
- VARIOUS COLORS AND LENS TYPES AVAILABLE.
- PACKAGE : 2000PCS / REEL.
- MOISTURE SENSITIVITY LEVEL : LEVEL 3.
- RoHS COMPLIANT.



Notes:

1. All dimensions are in millimeters (inches).
2. Tolerance is  $\pm 0.15(0.006)$ " unless otherwise noted.
3. Specifications are subject to change without notice.

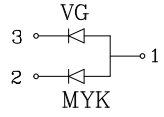
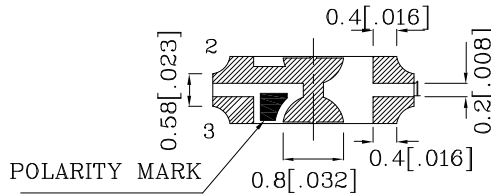
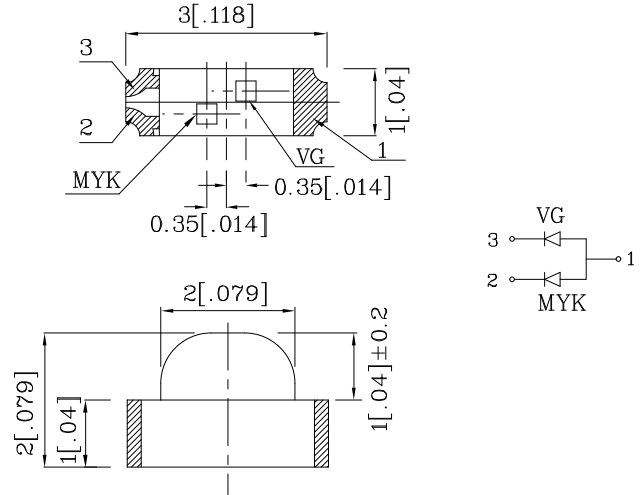

Absolute Maximum Ratings (TA=25°C)		MYK (InGaA IP)	VG (InGaA IP)	Unit
Reverse Voltage	VR	5	5	V
Forward Current	IF	30	30	mA
Forward Current (Peak) 1/10Duty Cycle 0.1ms Pulse Width	iFS	175	150	mA
Power Dissipation	PT	75	75	mW
Operating Temperature	TA	-40 ~ +85		°C
Storage Temperature	Tstg	-40 ~ +85		

Operating Characteristics (TA=25°C)		MYK (InGaA IP)	VG (InGaA IP)	Unit
Forward Voltage (Typ.) (IF=20mA)	VF	2.0	2.1	V
Forward Voltage (Max.) (IF=20mA)	VF	2.5	2.5	V
Reverse Current (Max.) (VR=5V)	IR	10	10	uA
Wavelength Of Peak Emission (Typ.) (IF=20mA)	λ P	590	574	nm
Wavelength Of Dominant Emission (Typ.) (IF=20mA)	λ D	590	570	nm
Spectral Line Full Width At Half-Maximum (Typ.) (IF=20mA)	Δλ	20	20	nm
Capacitance (Typ.) (VF=0V, f=1MHz)	C	20	15	pF

Part Number	Emitting Color	Emitting Material	Lens-color	Luminous Intensity (IF=20mA) mcd		Wavelength nm λ P	Viewing Angle 2 θ 1/2
				min.	typ.		
XZMYKVG56W	Yellow	InGaAlP	Water Clear	50	148	590	140°
	Green	InGaAlP		18	49		

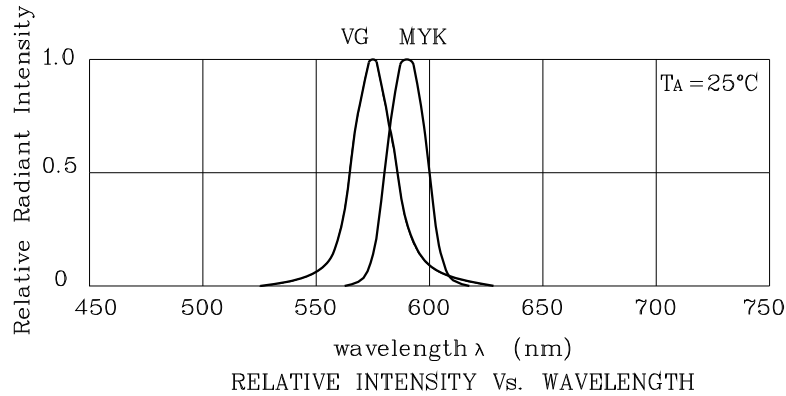

❖ MYK

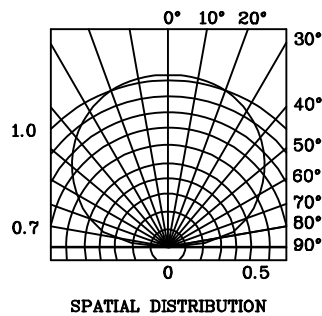
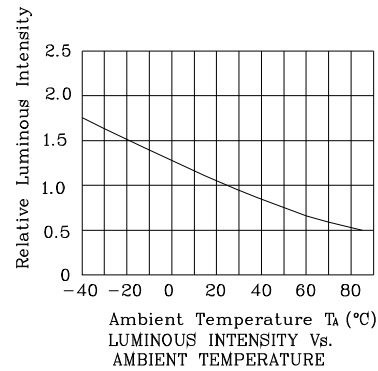
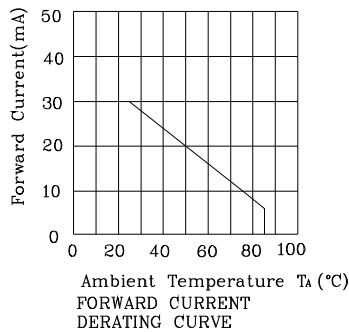
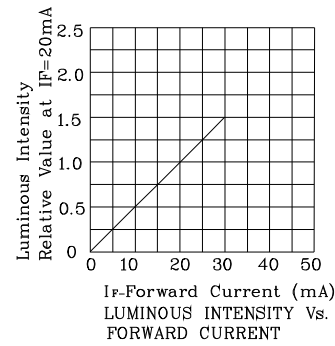
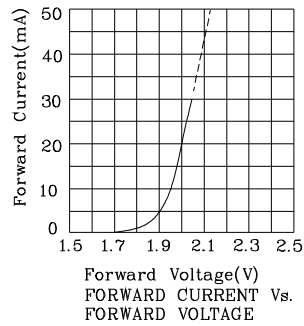

❖ VG

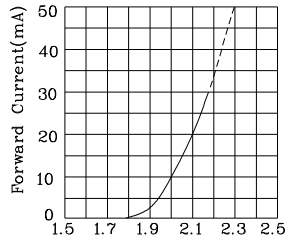

FORWARD CURRENT Vs.  
FORWARD VOLTAGE

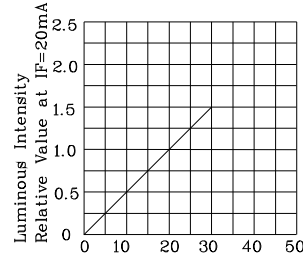

LUMINOUS INTENSITY Vs.  
FORWARD CURRENT

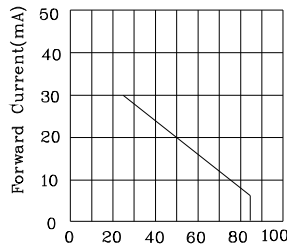

FORWARD CURRENT  
DERATING CURVE

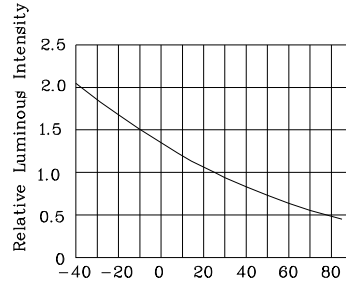

LUMINOUS INTENSITY Vs.  
AMBIENT TEMPERATURE

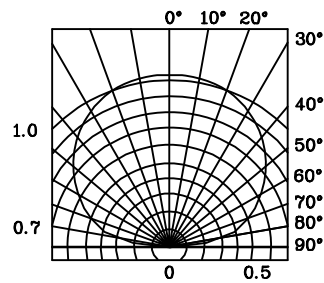

SPATIAL DISTRIBUTION

Reflow Soldering Profile For Lead-free SMT Process.

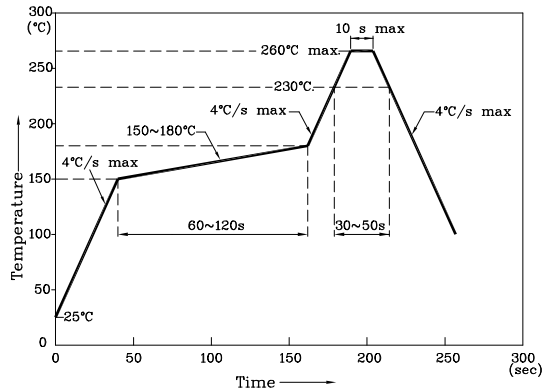

NOTES:

1. Maximum soldering temperature should not exceed 260°C.
2. Recommended reflow temperature: 145°C-260°C.
3. Do not put stress to the epoxy resin during high temperatures conditions.

❖ Recommended Soldering Pattern  
(Units : mm; Tolerance: ±0.1)

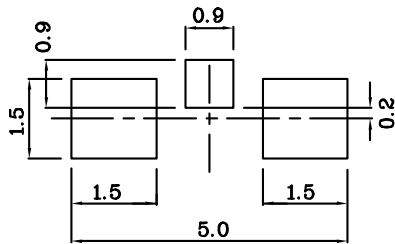

❖ The device has a single mounting surface. The device must be mounted according to the specifications.

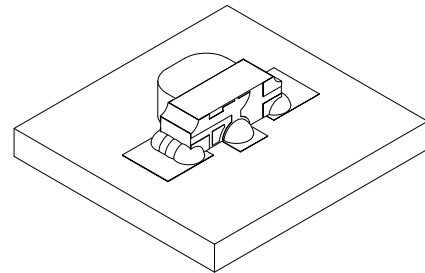

❖ Tape Specification (Units : mm)

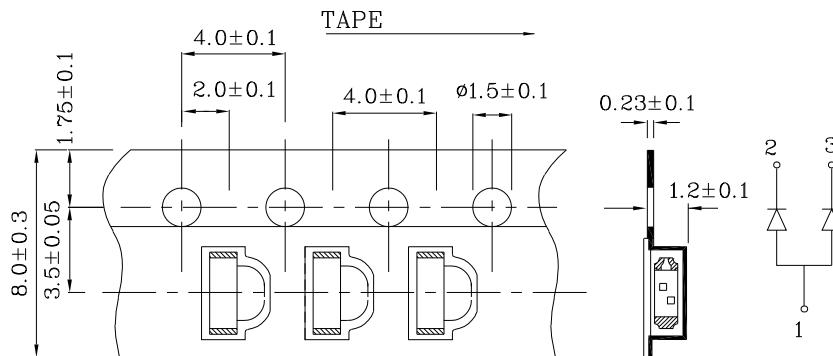

Remarks:

If special sorting is required (e.g. binning based on forward voltage, Luminous intensity / luminous flux, or wavelength), the typical accuracy of the sorting process is as follows:

1. Wavelength: +/-1nm
2. Luminous Intensity / Luminous Flux: +/-15%
3. Forward Voltage: +/-0.1V

Note: Accuracy may depend on the sorting parameters.

**PACKING & LABEL SPECIFICATIONS**

**XZMYKVG56W**

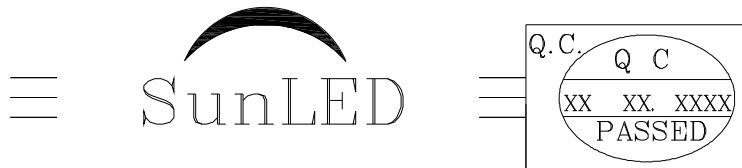
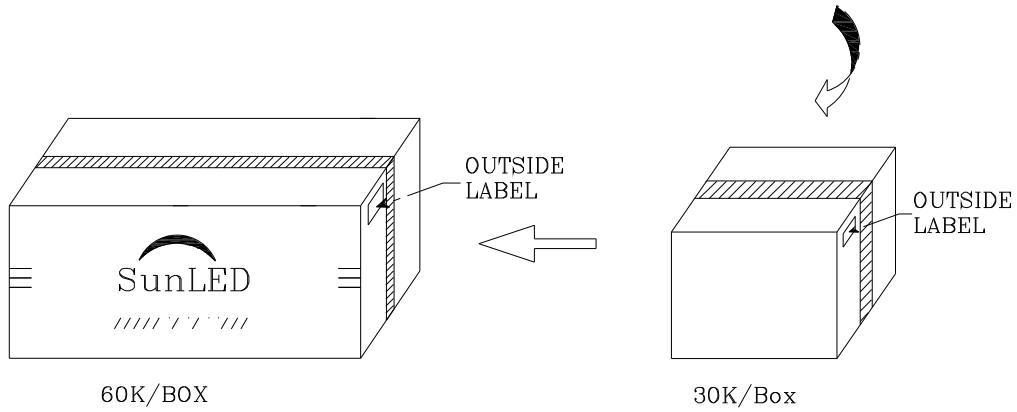
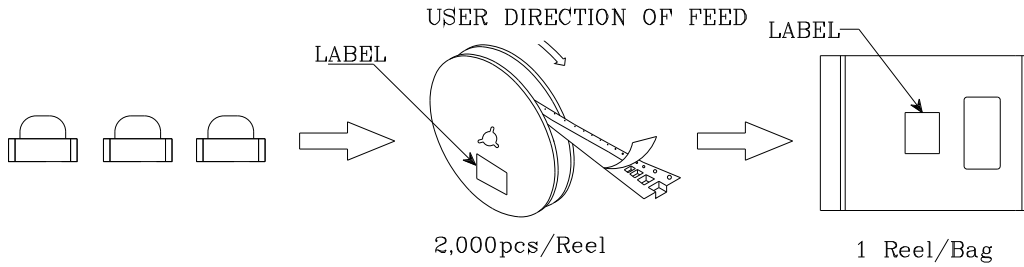

P/NO : XZxxx56x	
QTY : 2,000 pcs	CODE: XXX
S/N : XX	
LOT NO :	
 XXXXXXXXXXXXXXXXXXXXXXXXXXXX	
RoHS Compliant	