

**Features**

- SUBMINIATURE PACKAGE.
- WIDE VIEWING ANGLE.
- YOKE LEAD.
- LONG LIFE-SOLID STATE RELIABILITY.
- LOW PACKAGE PROFILE.
- PACKAGE : 1000PCS / REEL.
- MOISTURE SENSITIVITY LEVEL : LEVEL 3.
- RoHS COMPLIANT.



Notes:

1. All dimensions are in millimeters (inches).
2. Tolerance is  $\pm 0.25(0.01")$  unless otherwise noted.
3. Specifications are subject to change without notice.

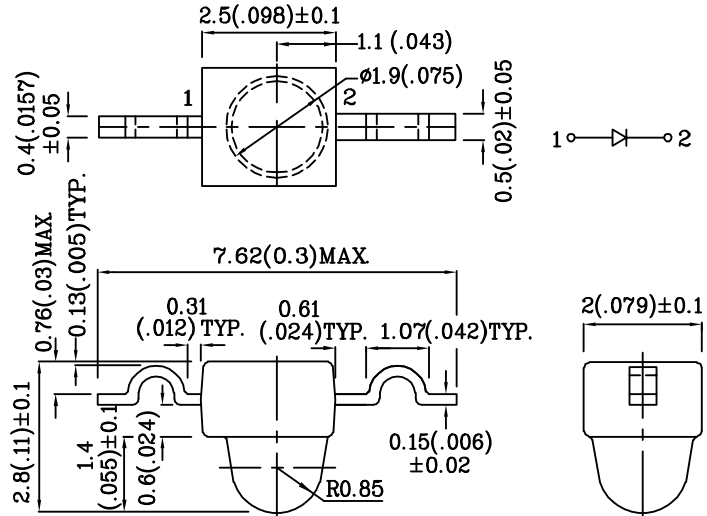

Absolute Maximum Ratings (TA=25°C)		MOK (InGaAlP)	Unit
Reverse Voltage	VR	5	V
Forward Current	IF	30	mA
Forward Current (Peak) 1/10 Duty Cycle 0.1ms Pulse Width	iFS	195	mA
Power Dissipation	PT	75	mW
Operating Temperature	TA	-40 ~ +85	°C
Storage Temperature	Tstg	-40 ~ +85	

Operating Characteristics (TA=25°C)		MOK (InGaAlP)	Unit
Forward Voltage (Typ.) (IF=20mA)	VF	2.1	V
Forward Voltage (Max.) (IF=20mA)	VF	2.5	V
Reverse Current (Max.) (VR=5V)	IR	10	uA
Wavelength Of Peak Emission (Typ.) (IF=20mA)	$\lambda P$	610	nm
Wavelength Of Dominant Emission (Typ.) (IF=20mA)	$\lambda D$	601	nm
Spectral Line Full Width At Half-Maximum (Typ.) (IF=20mA)	$\Delta\lambda$	29	nm
Capacitance (Typ.) (VF=0V, f=1MHz)	C	15	pF

Part Number	Emitting Color	Emitting Material	Lens-color	Luminous Intensity (IF=20mA) mcd		Wavelength nm $\lambda P$	Viewing Angle 2 $\theta$ 1/2
				min.	typ.		
XZMOK46W-8	Orange	InGaAlP	Water Clear	900	1790	610	20°

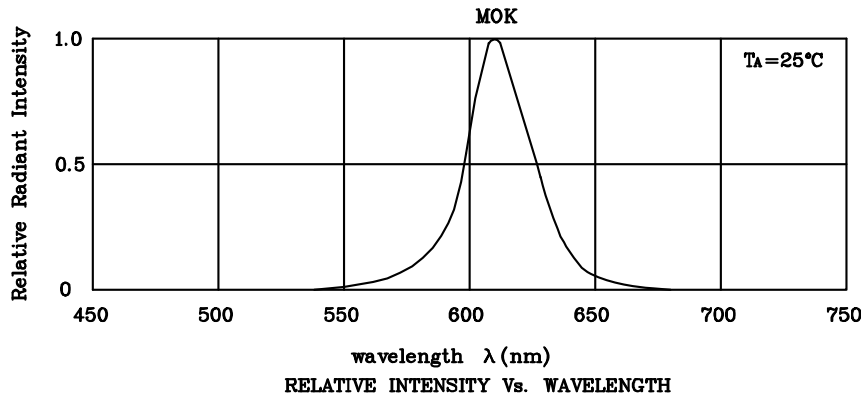

❖ **MOK**

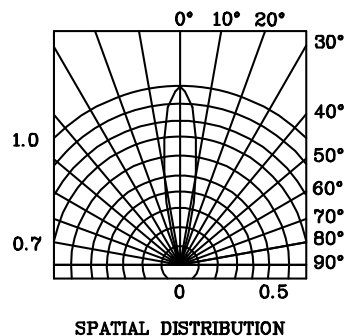
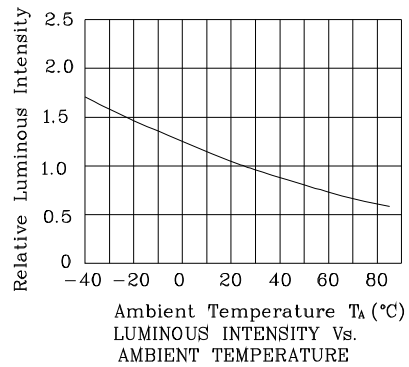
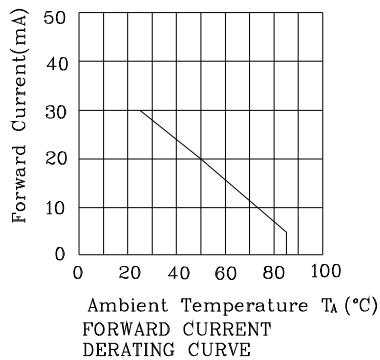
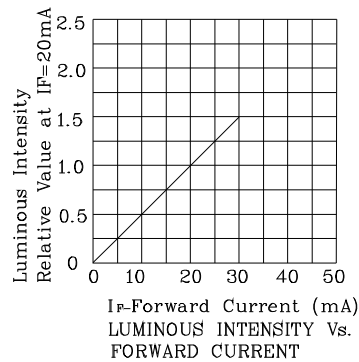
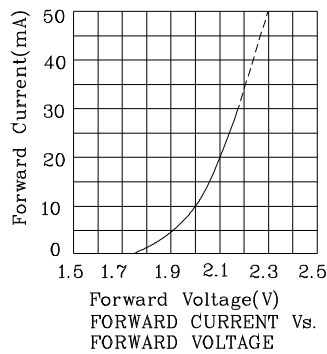

Reflow Soldering Profile For Lead-free SMT Process.

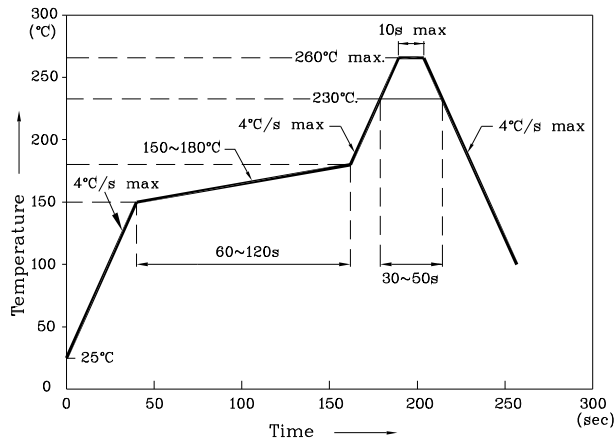

Notes:

1. Maximum soldering temperature should not exceed 260°C.
2. Recommended reflow temperature: 145°C-260°C.
3. Do not put stress to the epoxy resin during high temperatures conditions.

❖ Recommended Soldering Pattern  
(Units : mm; Tolerance: ± 0.1)

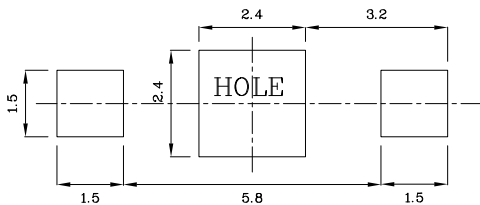

The device has a single mounting surface.  
The device must be mounted according to the specifications.

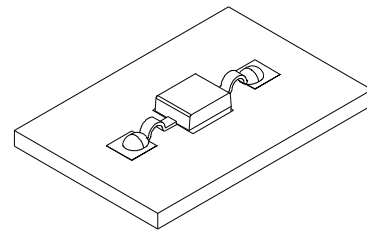

❖ Tape Specification (Units : mm)

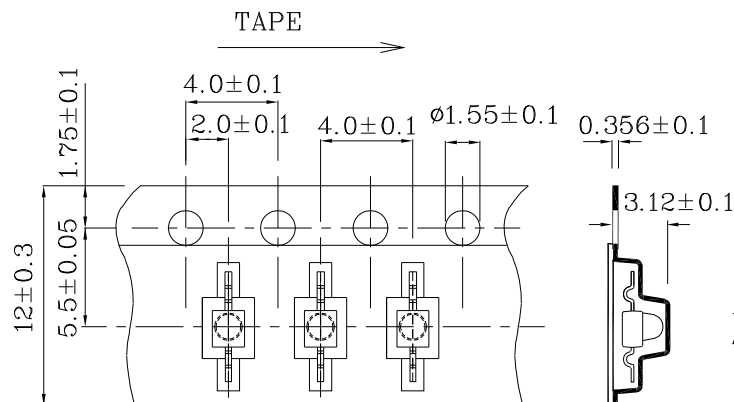

Remarks:

If special sorting is required (e.g. binning based on forward voltage, Luminous intensity / luminous flux, or wavelength), the typical accuracy of the sorting process is as follows:

1. Wavelength: +/-1nm
2. Luminous intensity / luminous flux: +/-15%
3. Forward Voltage: +/-0.1V

Note: Accuracy may depend on the sorting parameters.

**PACKING & LABEL SPECIFICATIONS**

**XZMOK46W-8**

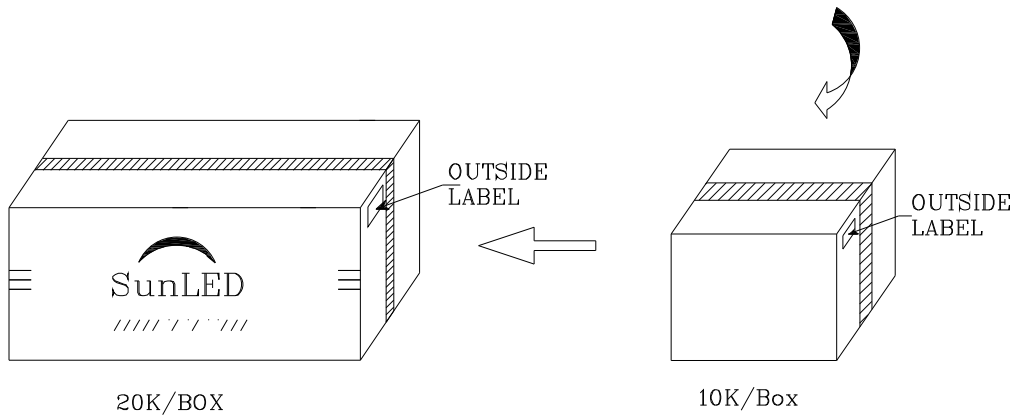
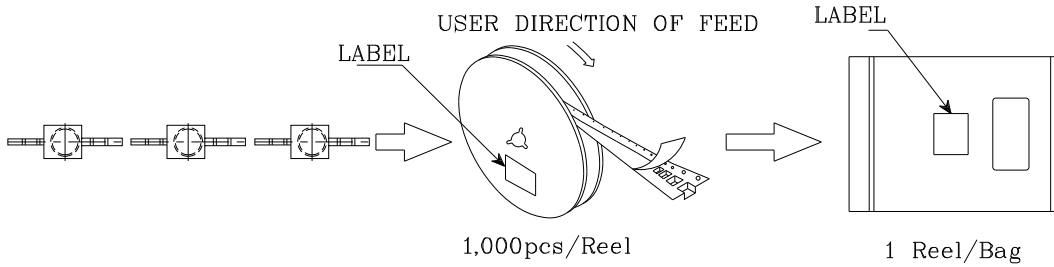

P/NO : XZxxx46x-8	
QTY : 1,000 pcs	CODE: XXX
S/N : XX	
LOT NO :	
 XXXXXXXXXXXXXXXXXXXXXXXXXXXX	
RoHS Compliant	