

Features

- 3.0mmx2.5mm SMT LED, 1.4mm THICKNESS.
- LOW POWER CONSUMPTION.
- WIDE VIEWING ANGLE.
- IDEAL FOR BACKLIGHT AND INDICATOR.
- VARIOUS COLORS AND LENS TYPES AVAILABLE.
- INNER LENS TYPE.
- PACKAGE : 2000PCS / REEL.
- RoHS COMPLIANT.

Notes:

1. All dimensions are in millimeters (inches).
2. Tolerance is $\pm 0.2(0.0079)$ unless otherwise noted.

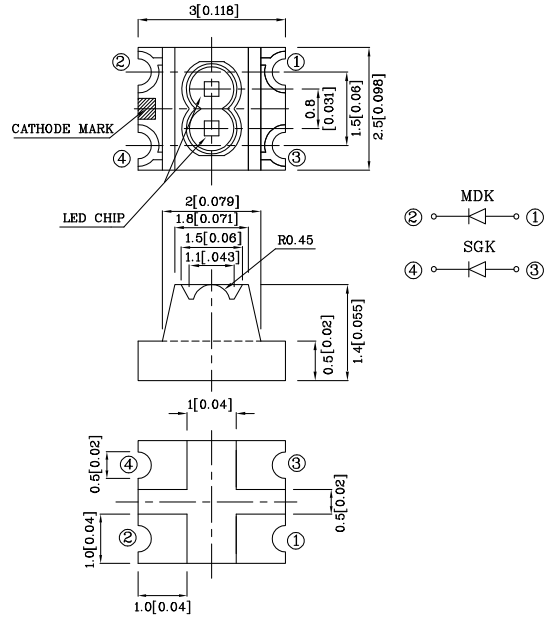

Absolute maximum ratings (TA=25°C)		MDK (InGaAlP)	SGK (InGaAlP)	Unit
Reverse Voltage	V _R	5	5	V
Forward Current	I _F	30	30	mA
Forward Current (Peak) 1/10 Duty Cycle 0.1ms Pulse Width	i _{FS}	185	150	mA
Power Dissipation	P _T	170	105	mW
Operating Temperature	T _A	-40 ~ +85		°C
Storage Temperature	T _{stg}	-40 ~ +85		

Operating Characteristics (TA=25°C)		MDK (InGaAlP)	SGK (InGaAlP)	Unit
Forward Voltage (Typ.) (I _F =20mA)	V _F	1.95	2.1	V
Forward Voltage (Max.) (I _F =20mA)	V _F	2.5	2.5	V
Reverse Current (V _R =5V)	I _R	10	10	µA
Wavelength of Peak Emission (I _F =20mA)	λ _P	650	574	nm
Wavelength of Dominant Emission (I _F =20mA)	λ _D	635	570	nm
Spectral Line Full Width At Half-Maximum (I _F =20mA)	Δλ	28	20	nm
Capacitance (V _F =0V, f=1MHz)	C	35	15	pF

Part Number	Emitting Color	Emitting Material	Lens-color	Luminous Intensity (I _F =20mA) mcd		Wavelength nm λ _P	Viewing Angle 2θ 1/2
				min.	typ.		
XZMDKSGK57W-1	Red	InGaAlP	Water Clear	110	297	650	100°
	Green	InGaAlP		50	89		

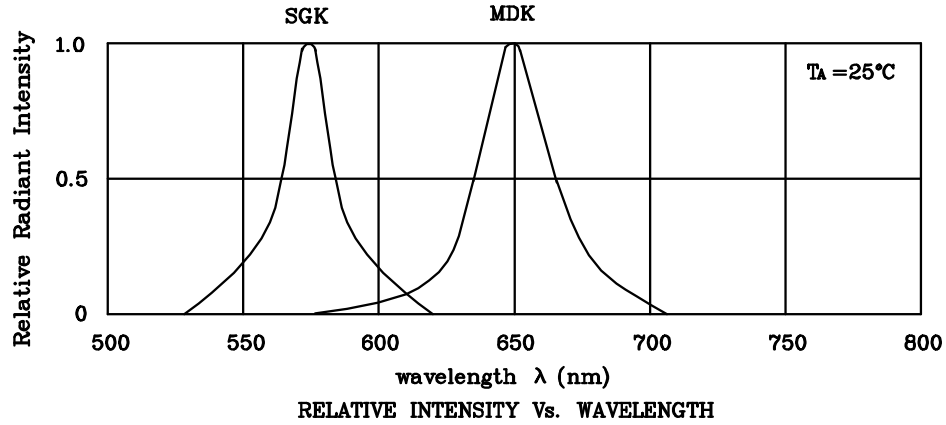

❖ MDK

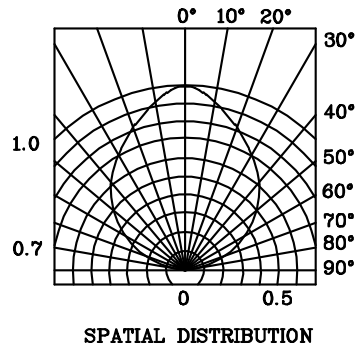
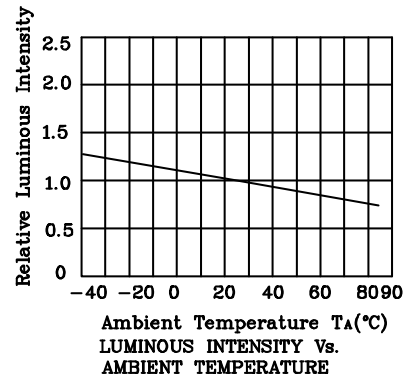
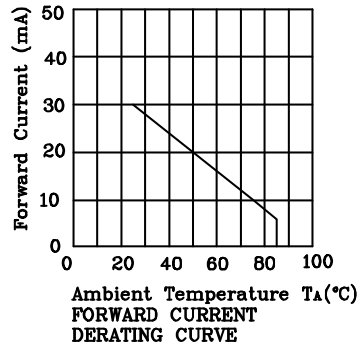
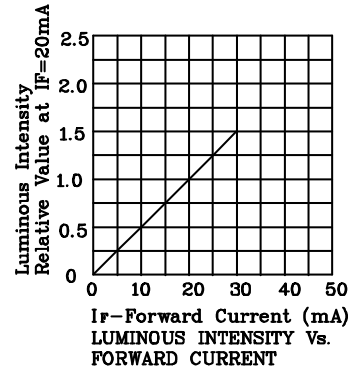
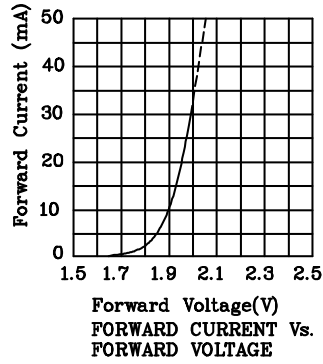

❖ SGK

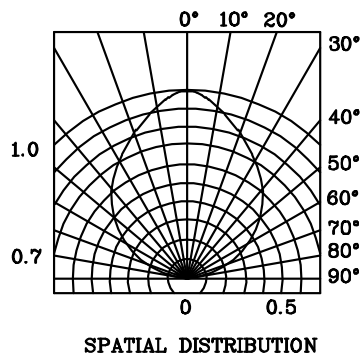
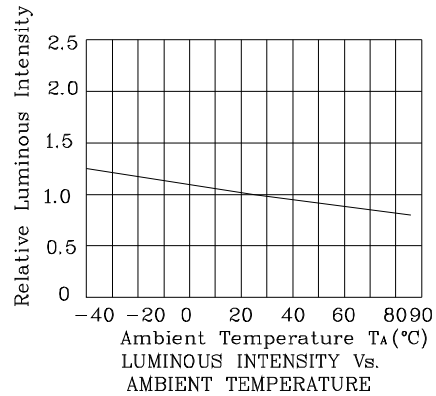
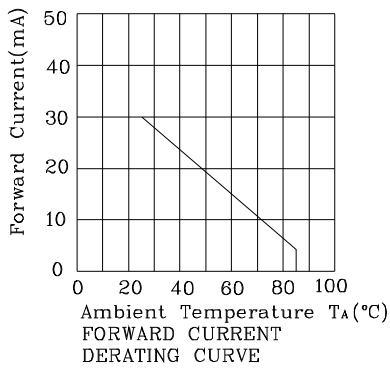
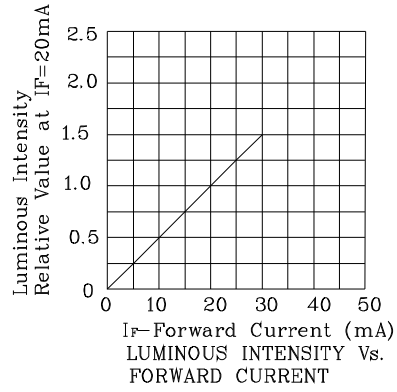
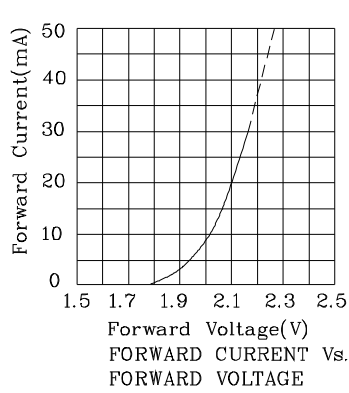

Reflow Soldering Profile For Lead-free SMT Process.

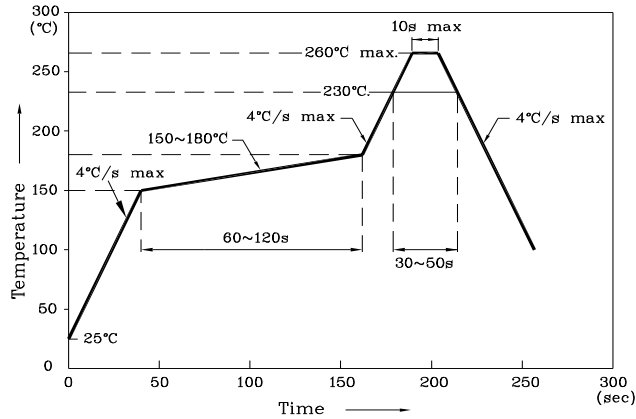

Notes:

1. Maximum soldering temperature should not exceed 260°C.
2. Recommended reflow temperature: 145°C-260°C.
3. Do not put stress to the epoxy resin during high temperatures conditions.

❖ Recommended Soldering Pattern (Units : mm; Tolerance: ± 0.1)

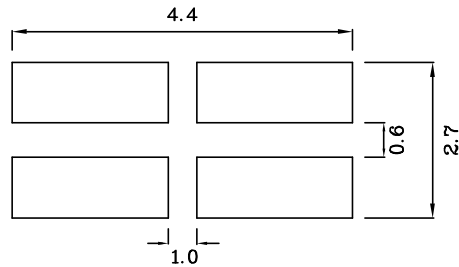

❖ Tape Specification (Units : mm)

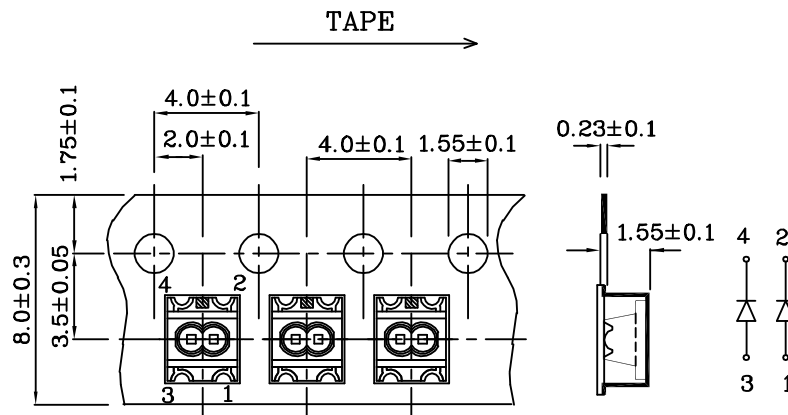

Remarks:

If special sorting is required (e.g. binning based on forward voltage, luminous intensity, or wavelength), the typical accuracy of the sorting process is as follows:

1. Wavelength: +/-1nm
2. Luminous Intensity: +/-15%
3. Forward Voltage: +/-0.1V

Note: Accuracy may depend on the sorting parameters.