

**Features**

- 1.6mmx0.6mm right angle SMT LED, 1.2mm thickness.
- Low power consumption.
- Wide viewing angle.
- Ideal for backlight and indicator.
- Various colors and lens types available.
- Package : 2000pcs / reel.
- Moisture sensitivity level : level 3.
- RoHS compliant.



Notes:

1. All dimensions are in millimeters (inches).
2. Tolerance is  $\pm 0.1(0.004)$ " unless otherwise noted.
3. Specifications are subject to change without notice.

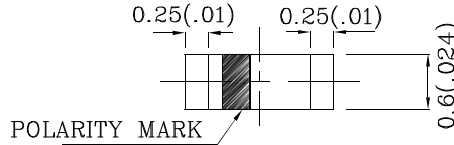
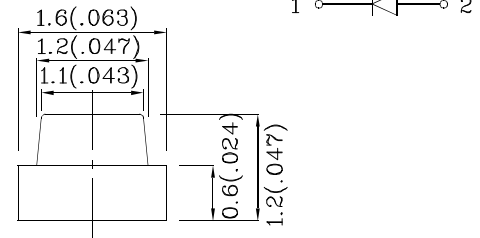
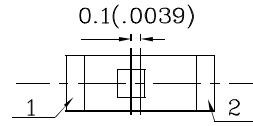

Absolute Maximum Ratings (TA=25°C)		MDK (InGaAlP)	Unit
Reverse Voltage	VR	5	V
Forward Current	IF	30	mA
Forward Current (Peak) 1/10 Duty Cycle 0.1ms Pulse Width	iFS	185	mA
Power Dissipation	PT	75	mW
Operating Temperature	TA	-40 ~ +85	°C
Storage Temperature	Tstg	-40 ~ +85	

Operating Characteristics (TA=25°C)		MDK (InGaAlP)	Unit
Forward Voltage (Typ.) (IF=20mA)	VF	1.95	V
Forward Voltage (Max.) (IF=20mA)	VF	2.5	V
Reverse Current (Max.) (VR=5V)	IR	10	uA
Wavelength of Peak Emission (Typ.) (IF=20mA)	λ P	650	nm
Wavelength of Dominant Emission (Typ.) (IF=20mA)	λ D	635	nm
Spectral Line Full Width At Half-Maximum (Typ.) (IF=20mA)	Δλ	28	nm
Capacitance (Typ.) (VF=0V, f=1MHz)	C	35	pF

Part Number	Emitting Color	Emitting Material	Lens-color	Luminous Intensity (IF=20mA)		Wavelength nm λ P	Viewing Angle 2 θ 1/2
				min.	typ.		
XZMDK87W	Red	InGaAlP	Water Clear	110	248	650	110°

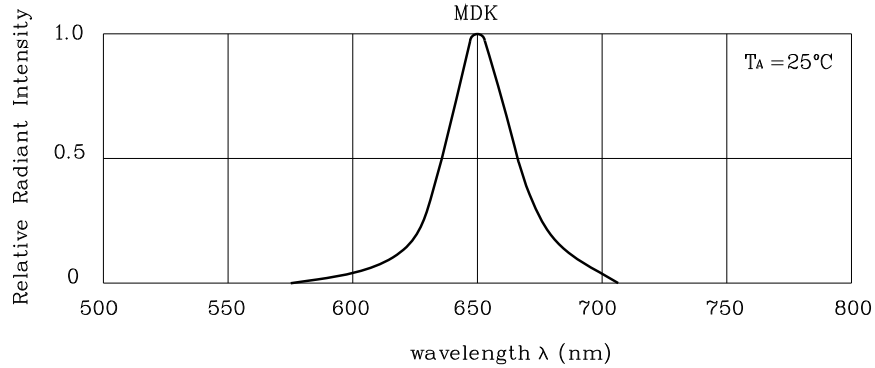

RELATIVE INTENSITY Vs. WAVELENGTH

❖ MDK

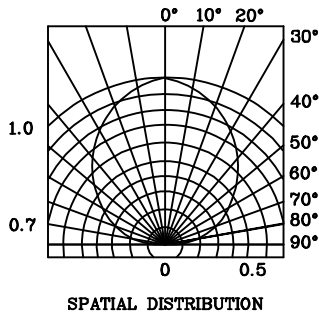
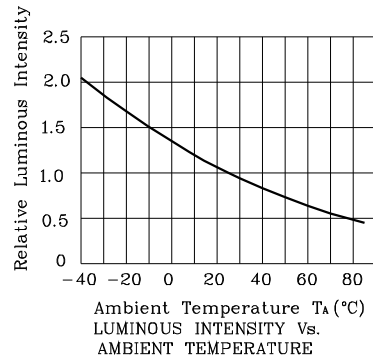
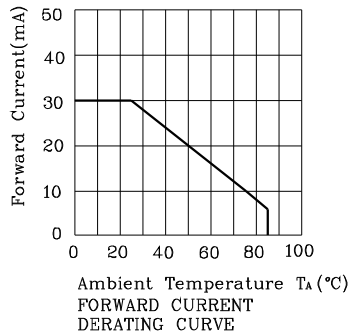
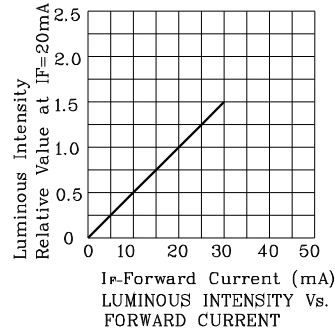
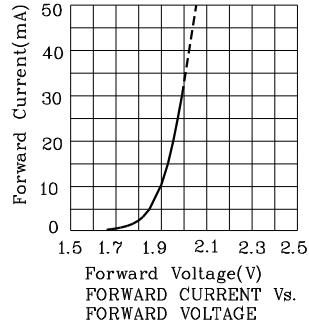

Reflow Soldering Profile For Lead-free SMT Process.

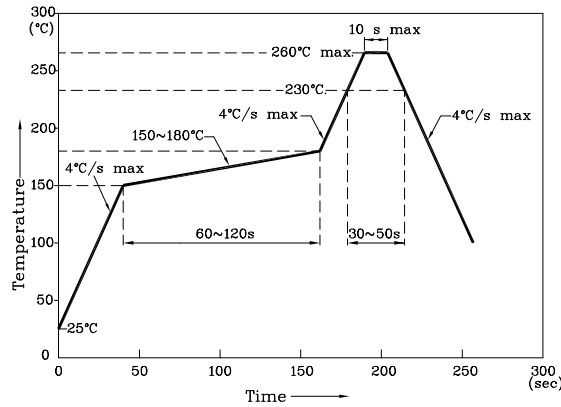

- NOTES:
1. Maximum soldering temperature should not exceed 260°C.
  2. Recommended reflow temperature: 145°C-260°C.
  3. Do not put stress to the epoxy resin during high temperatures conditions.

❖ Recommended Soldering Pattern  
(Units : mm; Tolerance: ±0.1)

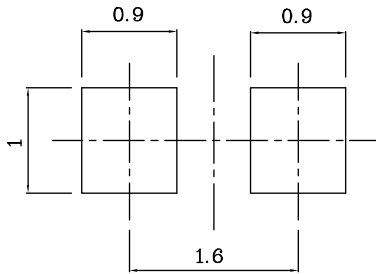

❖ The device has a single mounting surface. The device must be mounted according to the specifications.

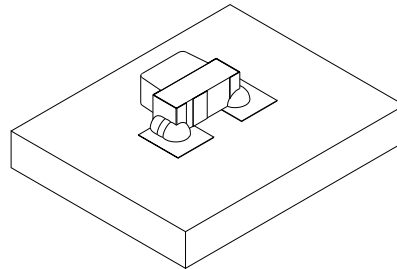

❖ Tape Specification (Units : mm)

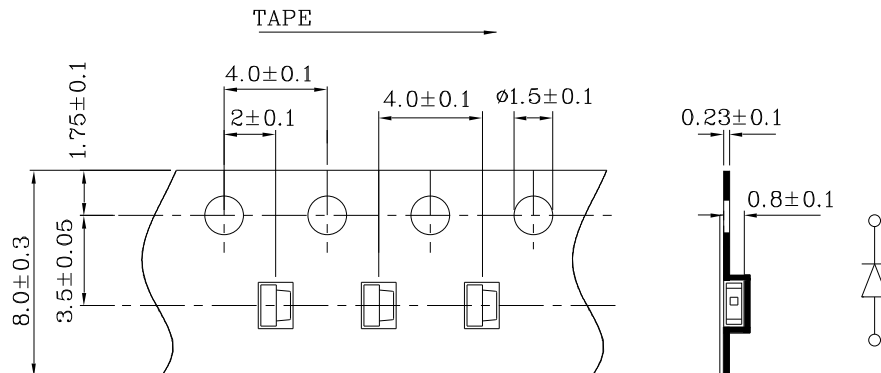

Remarks:

If special sorting is required (e.g. binning based on forward voltage, Luminous intensity / luminous flux, or wavelength), the typical accuracy of the sorting process is as follows:

1. Wavelength: +/-1nm
2. Luminous intensity / Luminous Flux: +/-15%
3. Forward Voltage: +/-0.1V

Note: Accuracy may depend on the sorting parameters.

**PACKING & LABEL SPECIFICATIONS**

**XZMDK87W**

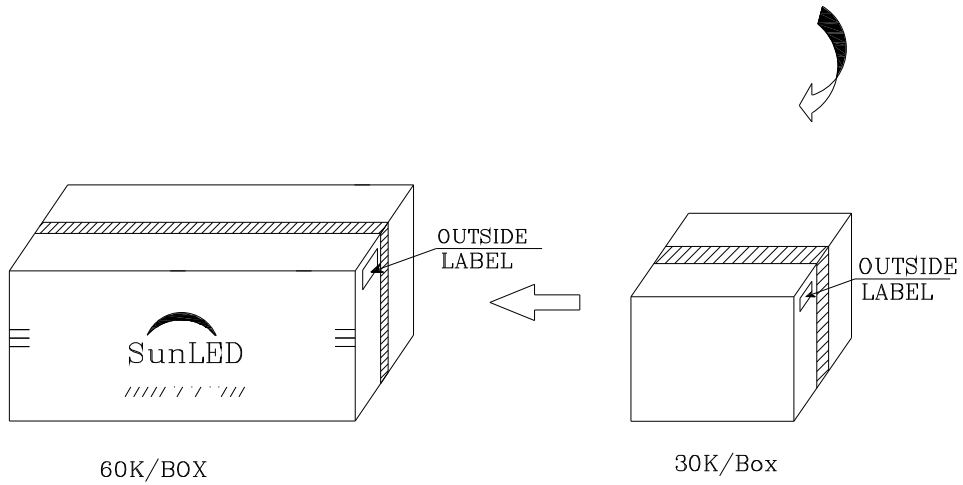
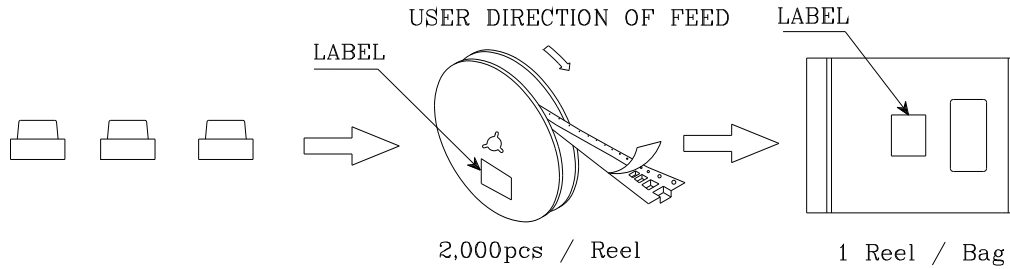

P/NO : XZxx87x

QTY : 2000 pcs      CODE: XXX

S/N : XX

LOT NO:



RoHS Compliant