



Features

- 3.2mmx1.6mm SMT LED,1.8mm THICKNESS.
- LOW POWER CONSUMPTION.
- WIDE VIEWING ANGLE.
- IDEAL FOR BACKLIGHT AND INDICATOR.
- VARIOUS COLORS AND LENS TYPES AVAILABLE.
- PACKAGE : 2000PCS / REEL.
- MOISTURE SENSITIVITY LEVEL : LEVEL 3.
- RoHS COMPLIANT.



Notes:

1. All dimensions are in millimeters (inches).
2. Tolerance is $\pm 0.2(0.008)$ " unless otherwise noted.
3. Specifications are subject to change without notice.

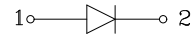
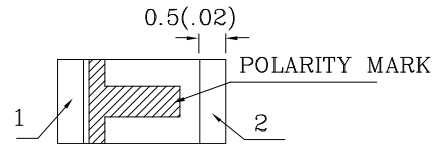
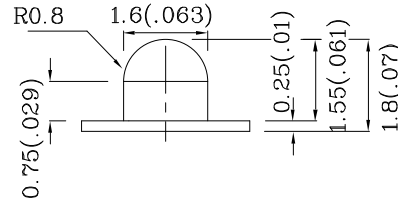
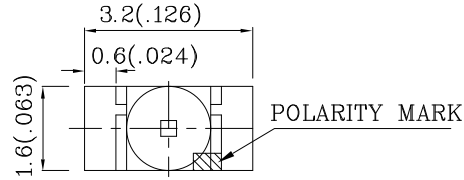

Absolute Maximum Ratings (TA=25°C)		MDK (InGaAlP)	Unit
Reverse Voltage	VR	5	V
Forward Current	IF	30	mA
Forward Current (Peak) 1/10 Duty Cycle 0.1ms Pulse Width	iFS	185	mA
Power Dissipation	PT	75	mW
Operating Temperature	TA	-40 ~ +85	°C
Storage Temperature	Tstg	-40 ~ +85	

Operating Characteristics (TA=25°C)		MDK (InGaAlP)	Unit
Forward Voltage (Typ.) (IF=20mA)	VF	1.95	V
Forward Voltage (Max.) (IF=20mA)	VF	2.5	V
Reverse Current (Max.) (VR=5V)	IR	10	uA
Wavelength Of Peak Emission (Typ.) (IF=20mA)	λP	650	nm
Wavelength Of Dominant Emission (Typ.) (IF=20mA)	λD	635	nm
Spectral Line Full Width At Half-Maximum (Typ.) (IF=20mA)	$\Delta\lambda$	28	nm
Capacitance (Typ.) (VF=0V, f=1MHz)	C	35	pF

Part Number	Emitting Color	Emitting Material	Lens-color	Luminous Intensity (IF=20mA) mcd		Wavelength nm λP	Viewing Angle 2 θ 1/2
				min.	typ.		
XZMDK55W-3	Red	InGaAlP	Water Clear	180	497	650	50°

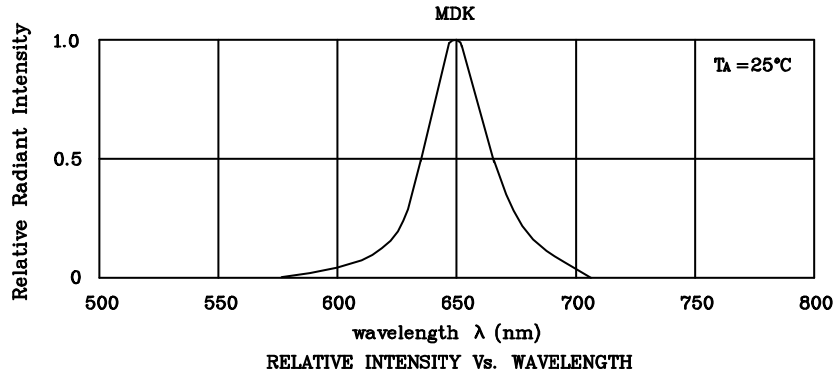

❖ MDK

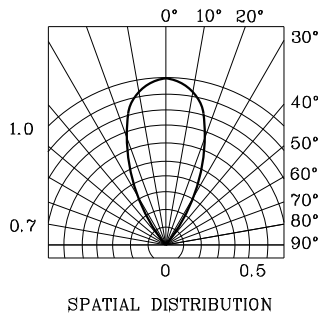
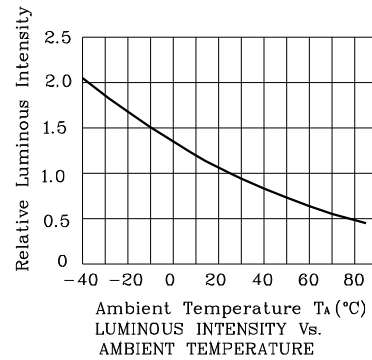
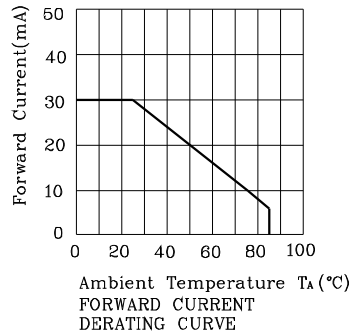
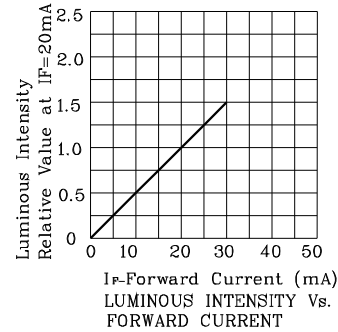
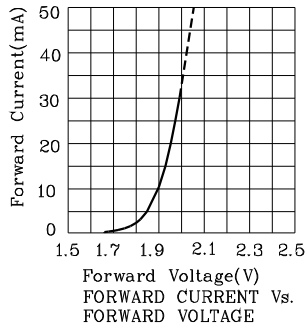

Reflow Soldering Profile For Lead-free SMT Process.

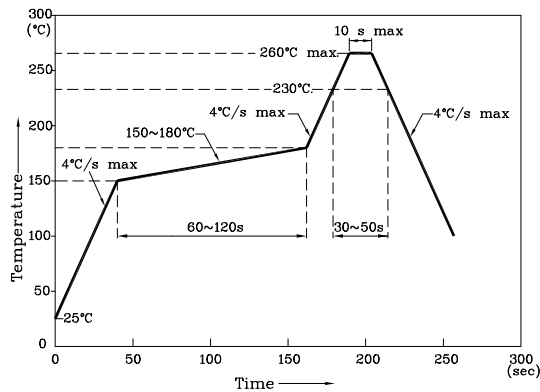

NOTES:

1. Maximum soldering temperature should not exceed 260°C.
2. Recommended reflow temperature: 145°C~260°C.
3. Do not put stress to the epoxy resin during high temperatures conditions.

❖ Recommended Soldering Pattern
(Units : mm; Tolerance: ±0.1)

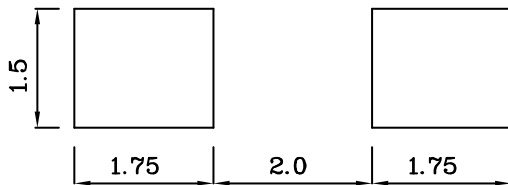

❖ The device has a single mounting surface. The device must be mounted according to the specifications.

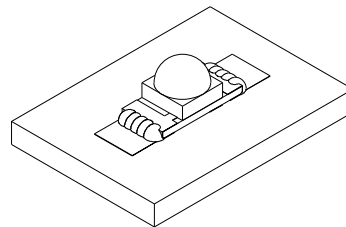

❖ Tape Specification (Units : mm)

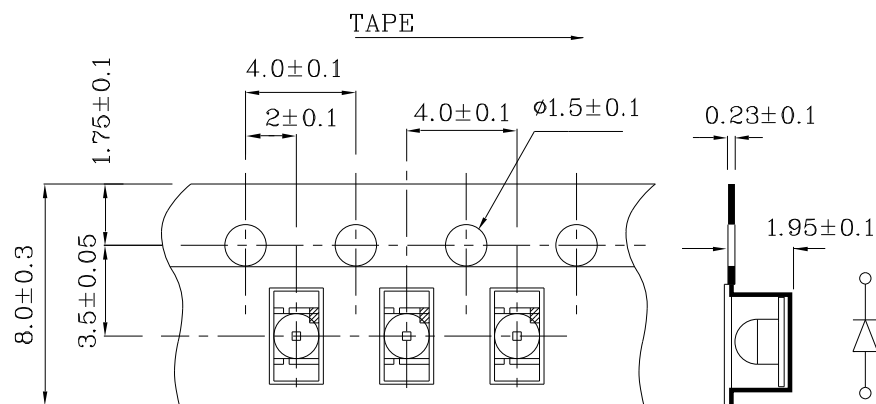

Remarks:

If special sorting is required (e.g. binning based on forward voltage, Luminous intensity / luminous flux, or wavelength), the typical accuracy of the sorting process is as follows:

1. Wavelength: +/-1nm
2. Luminous intensity / luminous flux: +/-15%
3. Forward Voltage: +/-0.1V

Note: Accuracy may depend on the sorting parameters.

PACKING & LABEL SPECIFICATIONS

XZMDK55W-3

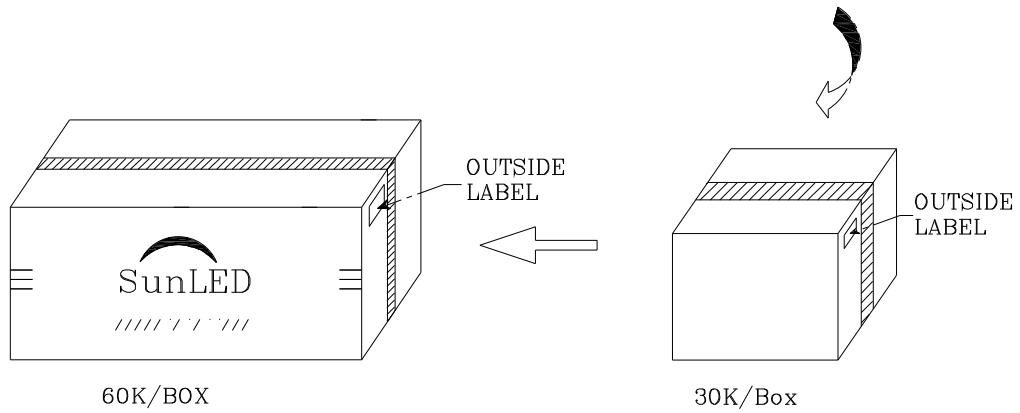
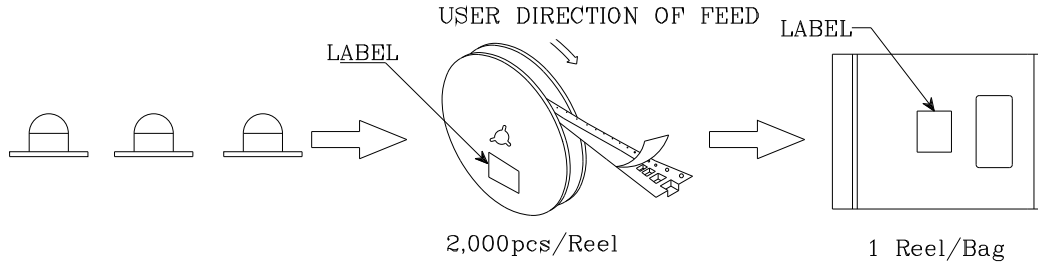

P/NO : XZxxx55x-3	
QTY : 2,000 pcs	CODE: XXX
S/N : XX	
LOT NO :	
 XXXXXXXXXXXXXXXXXXXXXXXX	
RoHS Compliant	