

Features

- 1.6mmx1.5mm SMT LED, 0.7mm THICKNESS.
- LOW POWER CONSUMPTION.
- WIDE VIEWING ANGLE.
- IDEAL FOR BACKLIGHT AND INDICATOR.
- VARIOUS COLORS AND LENS TYPES AVAILABLE.
- PACKAGE : 2000PCS / REEL.
- ELECTROSTATIC DISCHARGE CLASSIFICATION:
CLASS 1/HBM(MIL-STD-883METHOD3015.7)
- RoHS COMPLIANT.



ATTENTION
OBSERVE PRECAUTIONS
FOR HANDLING
ELECTROSTATIC
DISCHARGE
SENSITIVE

Notes:

1. All dimensions are in millimeters (inches).
2. Tolerance is $\pm 0.2(0.008)$ " unless otherwise noted.

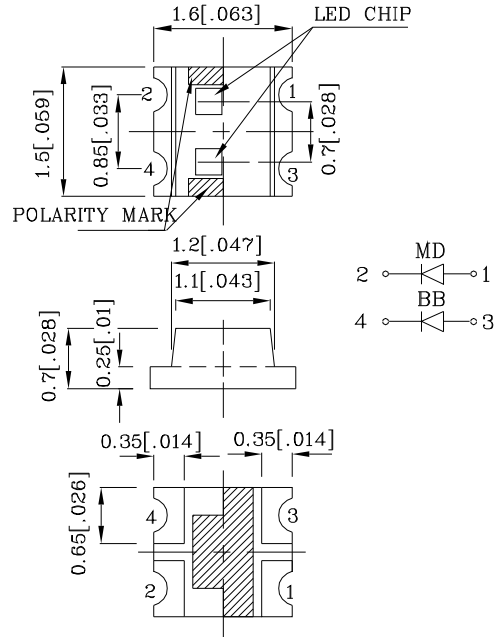

Absolute Maximum Ratings (TA=25°C)		MD (InGaA IP)	BB (InGaN)	Unit
Reverse Voltage	VR	5	5	V
Forward Current	IF	30	30	mA
Forward Current (Peak) 1/10 Duty Cycle 0.1ms Pulse Width	iFS	185	160	mA
Power Dissipation	PT	170	102	mW
Operating Temperature	TA	-40 ~ +85		°C
Storage Temperature	Tstg	-40 ~ +85		

Operating Characteristics (TA=25°C)		MD (InGaA IP)	BB (InGaN)	Unit
Forward Voltage (Typ.) (IF=20mA)	VF	1.9	3.65	V
Forward Voltage (Max.) (IF=20mA)	VF	2.5	4.2	V
Reverse Current (VR=5V)	IR	10	10	uA
Wavelength of Peak Emission (IF=20mA)	λ P	640	468	nm
Wavelength of Dominant Emission (IF=20mA)	λ D	628	470	nm
Spectral Line Full Width At Half-Maximum (IF=20mA)	Δλ	27	25	nm
Capacitance (VF=0V, f=1MHz)	C	45	65	pF

Part Number	Emitting Color	Emitting Material	Lens-color	Luminous Intensity (IF=20mA) mcd		Wavelength nm λ P	Viewing Angle 2 θ 1/2
				min.	typ.		
XZMDBB59W-1	Red	InGaAlP	Water Clear	70	198	640	120°
	Blue	InGaN		18	59		

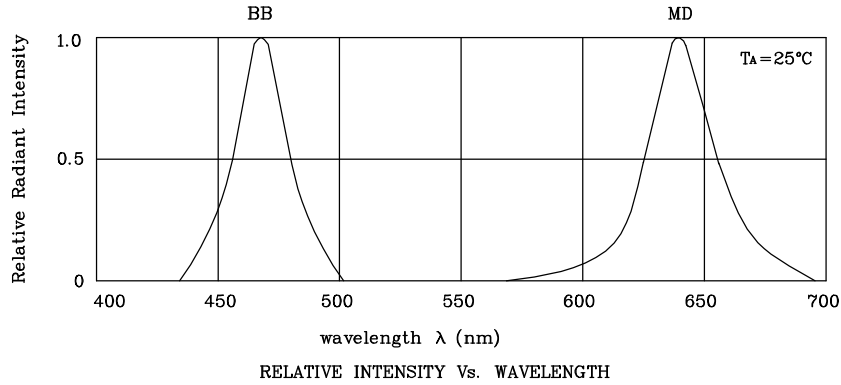

❖ MD

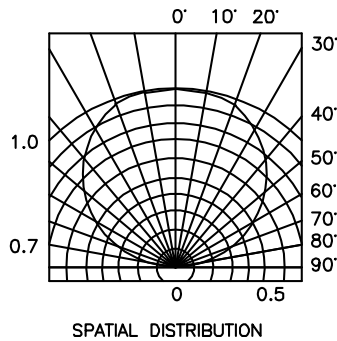
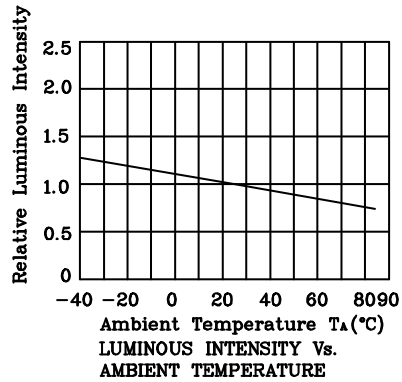
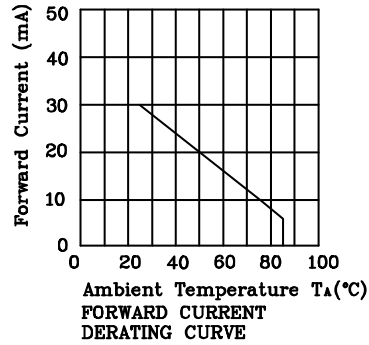
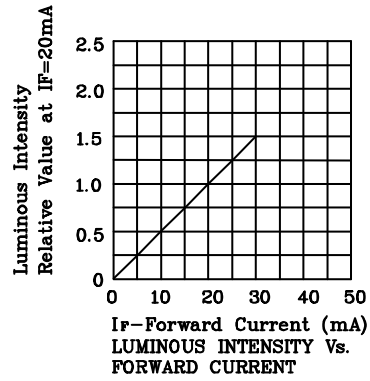
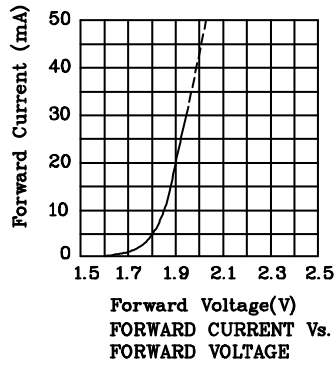

❖ BB

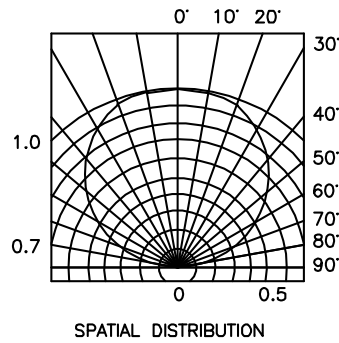
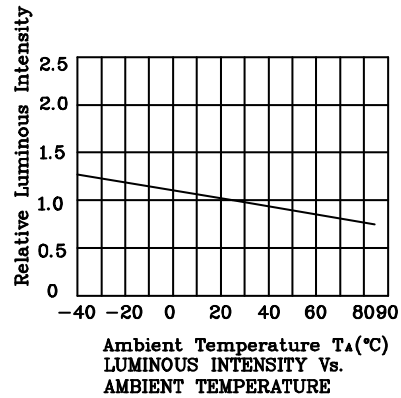
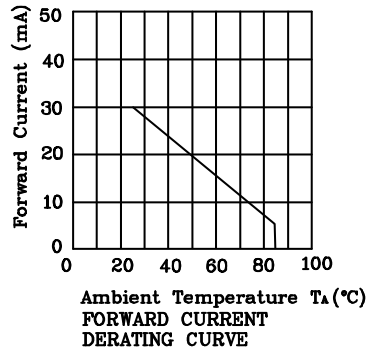
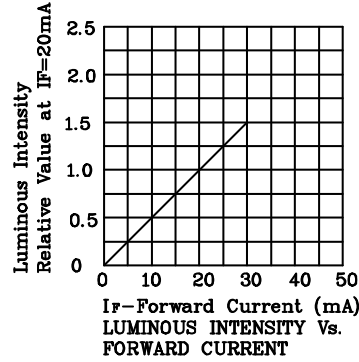
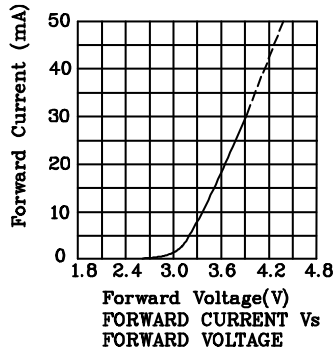

Reflow Soldering Profile For Lead-free SMT Process.

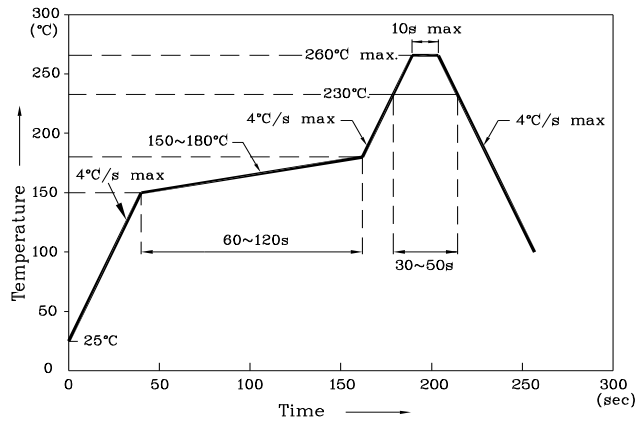

Notes:

1. Maximum soldering temperature should not exceed 260°C.
2. Recommended reflow temperature: 145°C-260°C.
3. Do not put stress to the epoxy resin during high temperatures conditions.

❖ Recommended Soldering Pattern (Units : mm; Tolerance: ± 0.1)

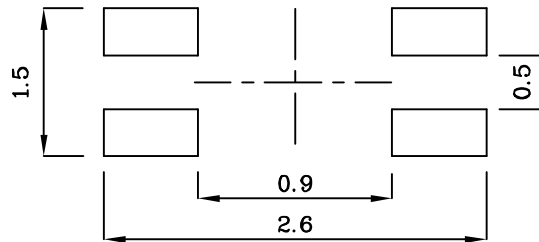

❖ Tape Specification (Units : mm)

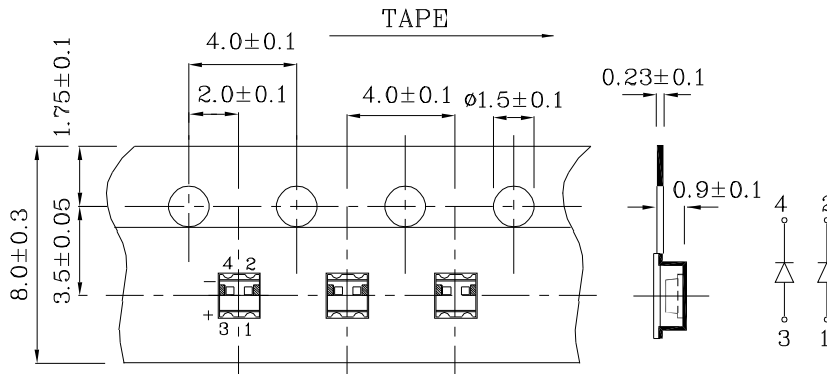

Remarks:

If special sorting is required (e.g. binning based on forward voltage, luminous intensity or wavelength), the typical accuracy of the sorting process is as follows:

1. Wavelength: +/-1nm
2. Luminous Intensity: +/-15%
3. Forward Voltage: +/-0.1V

Note: Accuracy may depend on the sorting parameters.