

Features

- 0.56 INCH DIGIT HEIGHT.
- LOW CURRENT OPERATION.
- EXCELLENT CHARACTER APPEARANCE.
- I.C. COMPATIBLE.
- MECHANICALLY RUGGED.
- GRAY FACE, WHITE SEGMENT.
- PACKAGE : 800PCS / REEL.

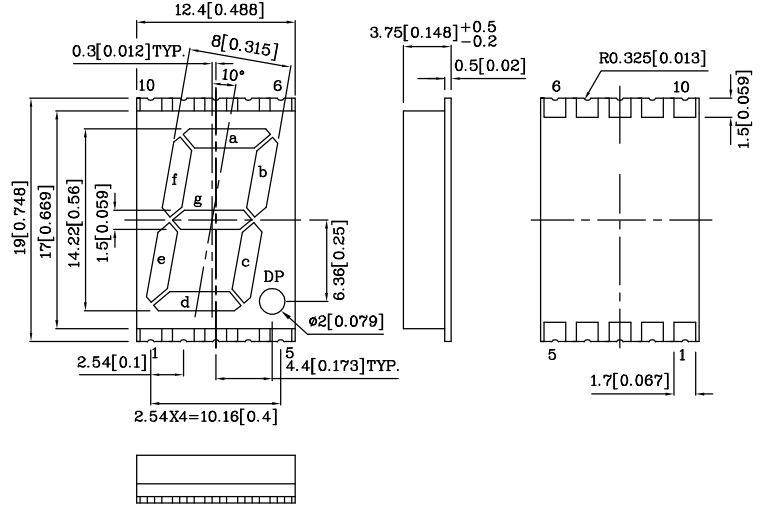
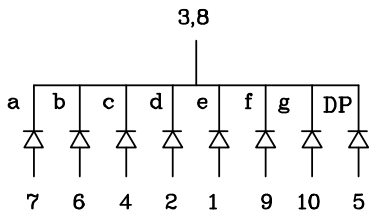

Notes:

1. All dimensions are in millimeters (inches).
2. Tolerance is $\pm 0.25(0.01)$ unless otherwise noted.

Absolute maximum ratings (TA=25°C)		MOK (InGaAlP)	Unit
Reverse voltage	VR	5	V
Forward current	IF	30	mA
Forward current (peak) 1/10Duty cycle 0.1ms pulse width	iFS	195	mA
Power dissipation	PT	75	mW
Operating temperature	TA	-40 ~ +85	°C
Storage temperature	Tstg	-40 ~ +85	

Operating Characteristics (TA=25°C)		MOK (InGaAlP)	Unit
Forward voltage (typ.) (IF=10mA)	VF	2.0	V
Forward voltage (max.) (IF=10mA)	VF	2.5	V
Reverse current (VR=5V)	IR	10	uA
Wavelength at peak emission (IF=10mA)	λ peak	610	nm
Wavelength at Dominate emission (IF=10mA)	λ D	601	nm
Spectral Line half-width (IF=10mA)	$\Delta\lambda$	29	nm
Capacitance (VF=0V, f=1MHz)	C	15	pF

Part Number	Emitting Color	Emitting Material	Luminous Intensity (IF=10mA) ucd		Wavelength nm λ P	Description
			min.	typ.		
XZDMOK14C	Orange	InGaAlP	12000	40000	610	Common Cathode.Rt. Hand Decimal

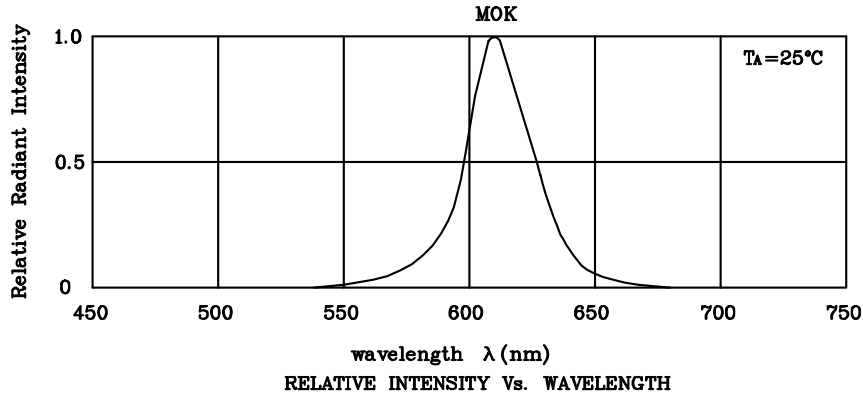

❖ **MOK**

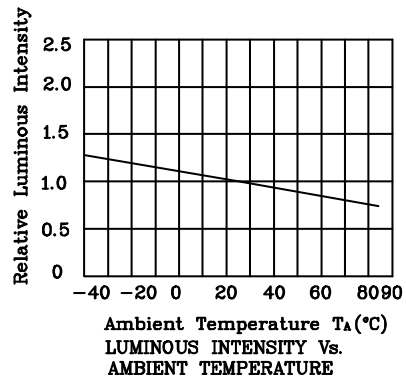
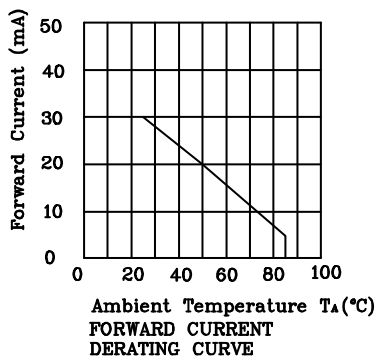
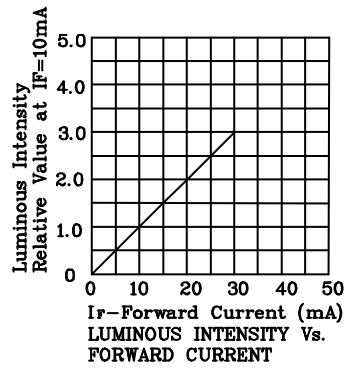
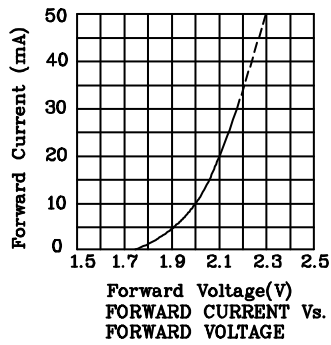

❖ SMT Reflow Soldering Instructions

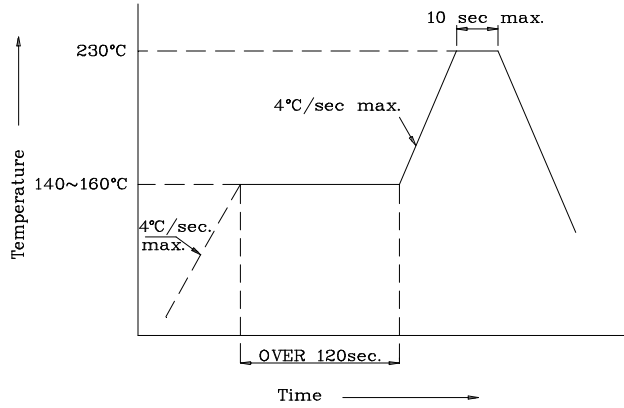

❖ Recommended Soldering Pattern (Units : mm;Tolerance:± 0.15)

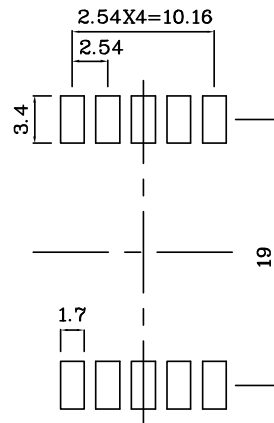

❖ Tape Specification (Units : mm)

