

PRELIMINARY SPEC

Features

- SUBMINIATURE PACKAGE.
- WIDE VIEWING ANGLE.
- Z-BEND LEAD.
- LONG LIFE-SOLID STATE RELIABILITY.
- LOW PACKAGE PROFILE.
- PACKAGE : 1000PCS / REEL.
- MOISTURE SENSITIVITY LEVEL : LEVEL 3.
- RoHS COMPLIANT.



ATTENTION
OBSERVE PRECAUTIONS
FOR HANDLING
ELECTROSTATIC
DISCHARGE
SENSITIVE
DEVICES

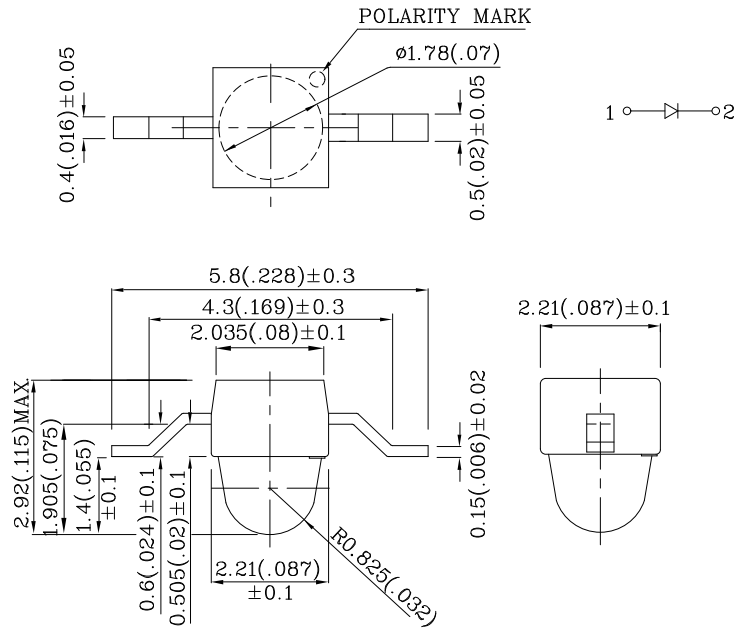

Notes:

1. All dimensions are in millimeters (inches).
2. Tolerance is ± 0.25(0.01") unless otherwise noted.
3. Specifications are subject to change without notice.

Absolute Maximum Ratings (TA=25°C)		BGA (InGaN)	Unit
Reverse Voltage	VR	5	V
Forward Current	IF	30	mA
Forward Current (Peak) 1/10 Duty Cycle 0.1ms Pulse Width	iFS	100	mA
Power Dissipation	PT	120	mW
Operating Temperature	TA	-40 ~ +85	°C
Storage Temperature	Tstg	-40 ~ +85	
Electrostatic Discharge Threshold (HBM)		1000	V

Operating Characteristics (TA=25°C)		BGA (InGaN)	Unit
Forward Voltage (Typ.) (IF=20mA)	VF	3.2	V
Forward Voltage (Max.) (IF=20mA)	VF	4.0	V
Reverse Current (Max.) (VR=5V)	IR	10	uA
Wavelength of Peak Emission (Typ.) (IF=20mA)	λ P	520	nm
Wavelength of Dominant Emission (Typ.) (IF=20mA)	λ D	525	nm
Spectral Line Full Width At Half-Maximum (Typ.) (IF=20mA)	Δλ	35	nm
Capacitance (Typ.) (VF=0V, f=1MHz)	C	100	pF

Part Number	Emitting Color	Emitting Material	Lens-color	Luminous Intensity (IF=20mA) mcd		Wavelength nm λ P	Viewing Angle 2 θ 1/2
				min.	typ.		
XZBGA64W-9	Green	InGaN	Water Clear	380	795	520	20°
Published Date : JAN 19,2008 Drawing No : XDSA9858 V2 Checked : B.L.LIU P.1/4							

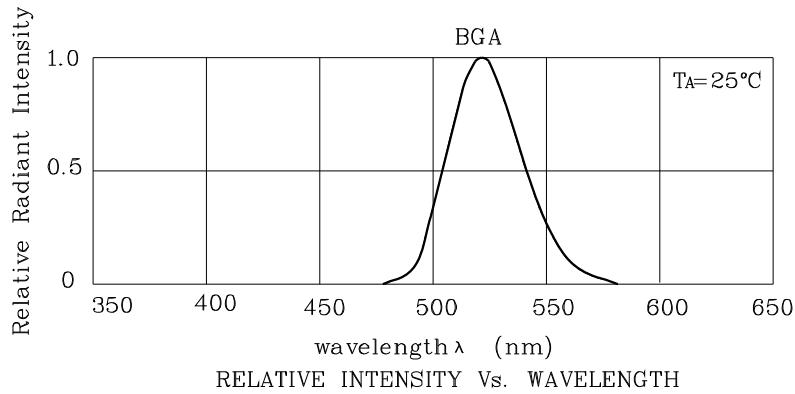

❖ BGA

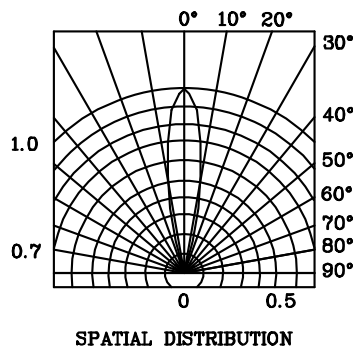
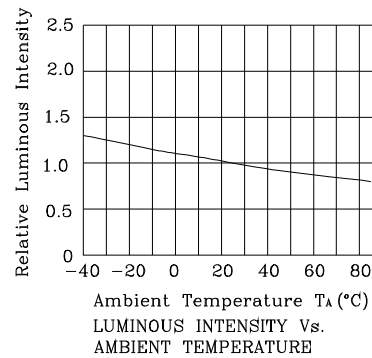
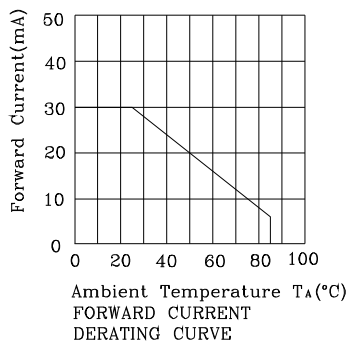
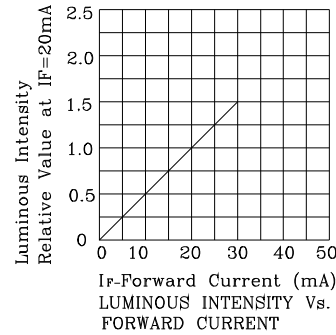
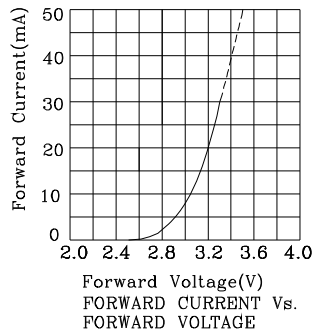

Reflow Soldering Profile For Lead-free SMT Process.

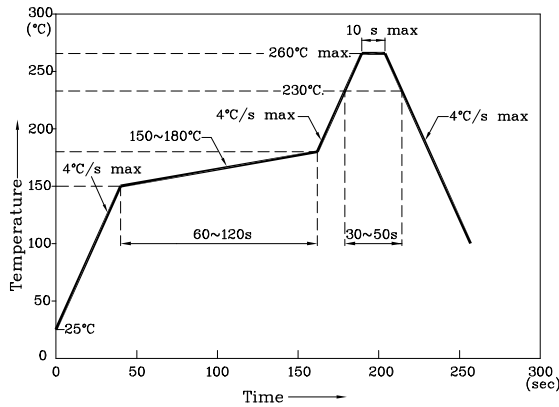

NOTES:

1. Maximum soldering temperature should not exceed 260°C.
2. Recommended reflow temperature: 145°C-260°C.
3. Do not put stress to the epoxy resin during high temperatures conditions.

❖ Recommended Soldering Pattern
(Units : mm; Tolerance:± 0.1)

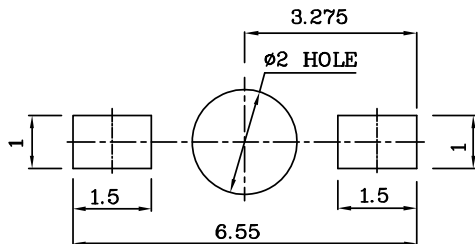

❖ The device has a single mounting surface. The device must be mounted according to the specifications.

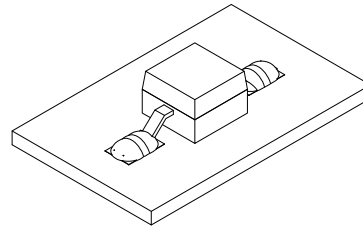

❖ Tape Specification (Units : mm)

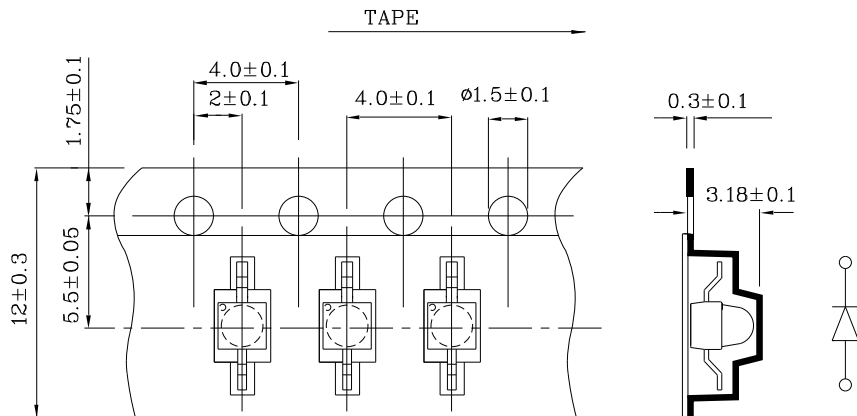

Remarks:



If special sorting is required (e.g. binning based on forward voltage, Luminous intensity / luminous flux, or wavelength), the typical accuracy of the sorting process is as follows:



1. Wavelength: +/-1nm
2. Luminous intensity / luminous flux: +/-15%
3. Forward Voltage: +/-0.1V

Note: Accuracy may depend on the sorting parameters.

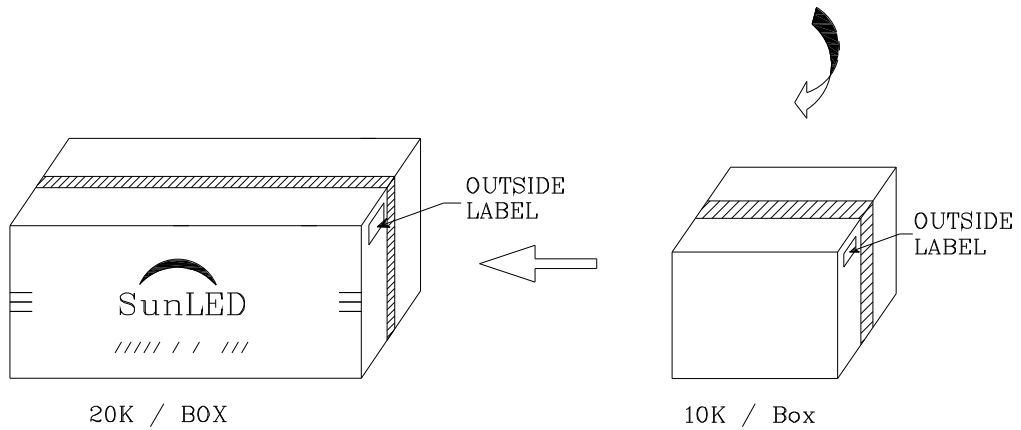
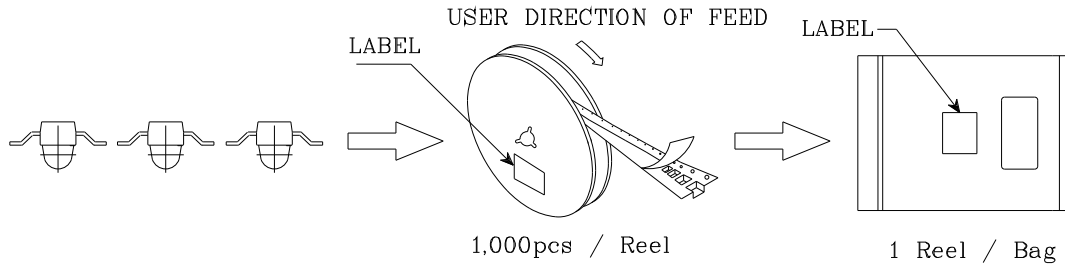
PACKING & LABEL SPECIFICATIONS

XZBGA64W-9

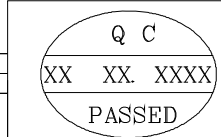
	
P/NO : XZxx64x-9	
QTY : 1,000 pcs	CODE: XXX
S/N : XX	
LOT NO:	
 XXXXXXXXXXXXXXXXXXXXXXXX	
RoHS Compliant	