

PRELIMINARY SPEC

Features

- SUBMINIATURE PACKAGE.
- GULL WING LEAD.
- LONG LIFE - SOLID STATE RELIABILITY.
- LOW PACKAGE PROFILE.
- PACKAGE : 1000PCS / REEL.
- MOISTURE SENSITIVITY LEVEL : LEVEL 3.
- RoHS COMPLIANT.

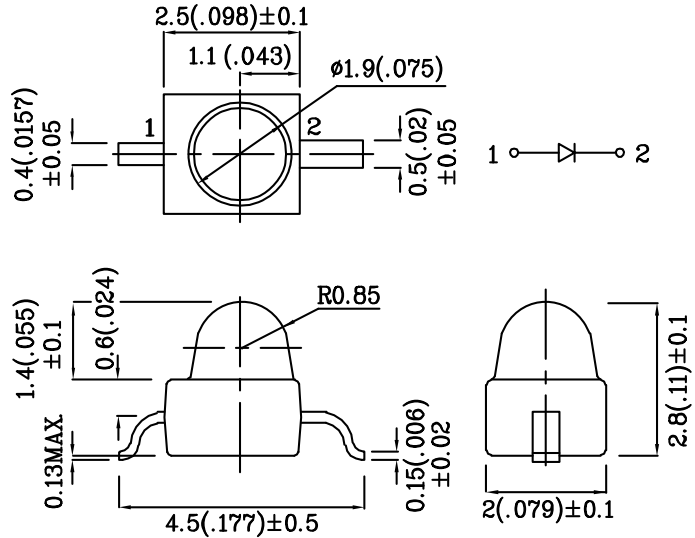

ATTENTION
OBSERVE PRECAUTIONS
FOR HANDLING
ELECTROSTATIC
DISCHARGE
SENSITIVE
DEVICES

Notes:

1. All dimensions are in millimeters (inches).
2. Tolerance is ± 0.25(0.01") unless otherwise noted.
3. Specifications are subject to change without notice.

Absolute Maximum Ratings (TA=25°C)		BGA (InGaN)	Unit
Reverse Voltage	V _R	5	V
Forward Current	I _F	30	mA
Forward Current (Peak) 1/10 Duty Cycle 0.1ms Pulse Width	i _{FS}	100	mA
Power Dissipation	P _T	120	mW
Operating Temperature	T _A	-40 ~ +85	°C
Storage Temperature	T _{stg}	-40 ~ +85	
Electrostatic Discharge Threshold (HBM)		1000	V

Operating Characteristics (TA=25°C)		BGA (InGaN)	Unit
Forward Voltage (Typ.) (I _F =20mA)	V _F	3.2	V
Forward Voltage (Max.) (I _F =20mA)	V _F	4.0	V
Reverse Current (Max.) (V _R =5V)	I _R	10	uA
Wavelength Of Peak Emission (Typ.) (I _F =20mA)	λ P	520	nm
Wavelength Of Domi- nant Emission (Typ.) (I _F =20mA)	λ D	525	nm
Spectral Line Full Width At Half-Maximum (Typ.) (I _F =20mA)	Δλ	35	nm
Capacitance (Typ.) (V _F =0V, f=1MHz)	C	100	pF

Part Number	Emitting Color	Emitting Material	Lens-color	Luminous Intensity (I _F =20mA) mcd		Wavelength nm λ P	Viewing Angle 2 θ 1/2
				min.	typ.		
XZBGA46W-3	Green	InGaN	Water Clear	380	795	520	20°
Published Date : JAN 21,2008 Drawing No : XDSA9850 V2 Checked : B.L.LIU P.1/4							

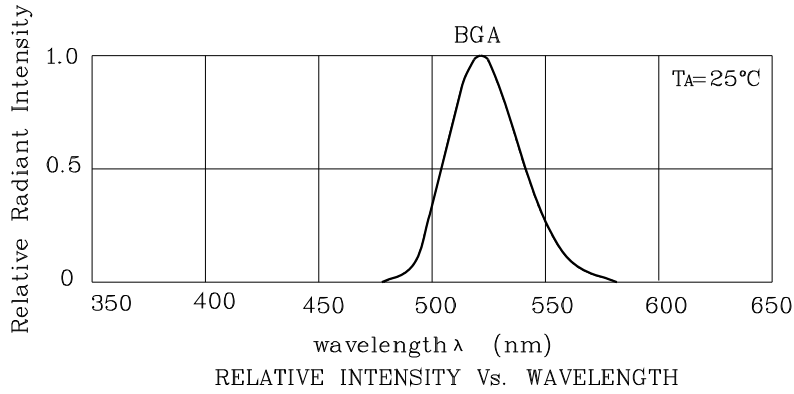

❖ BGA

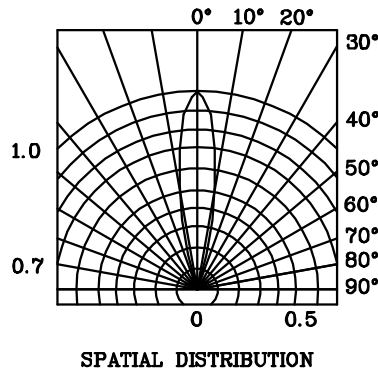
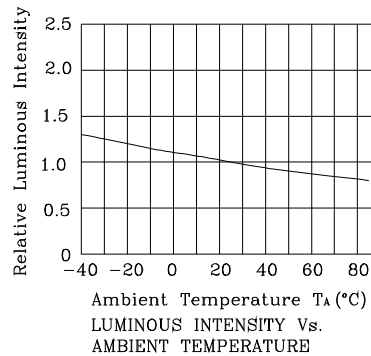
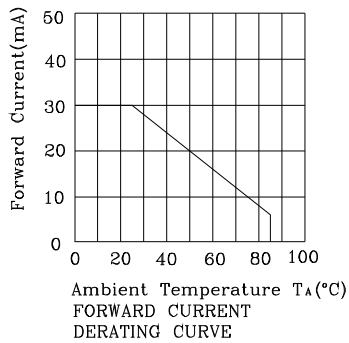
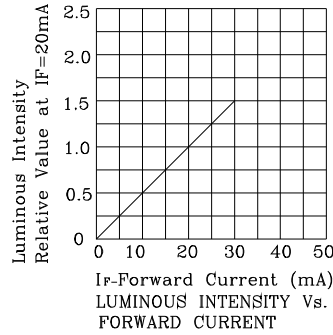
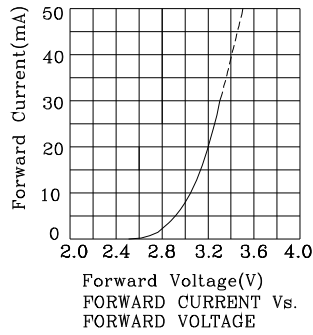

Reflow Soldering Profile For Lead-free SMT Process.

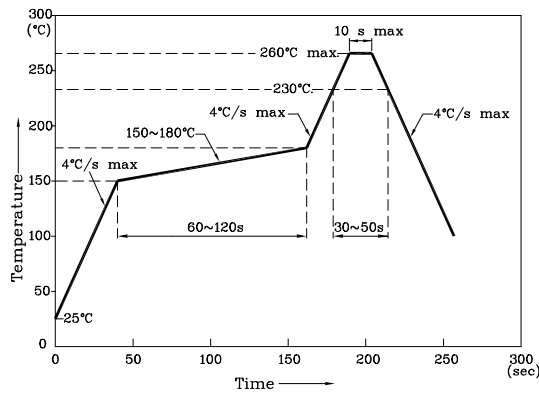

NOTES:

1. Maximum soldering temperature should not exceed 260°C.
2. Recommended reflow temperature: 145°C-260°C.
3. Do not put stress to the epoxy resin during high temperatures conditions.

❖ Recommended Soldering Pattern
(Units : mm; Tolerance: ± 0.1)

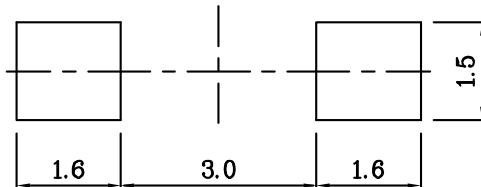

❖ The device has a single mounting surface. The device must be mounted according to the specifications.

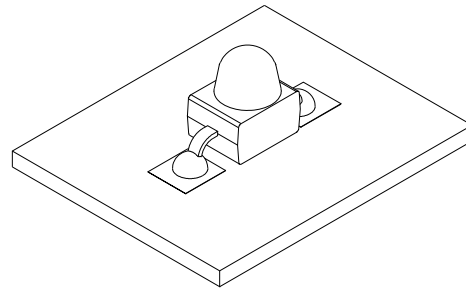

❖ Tape Specification (Units : mm)

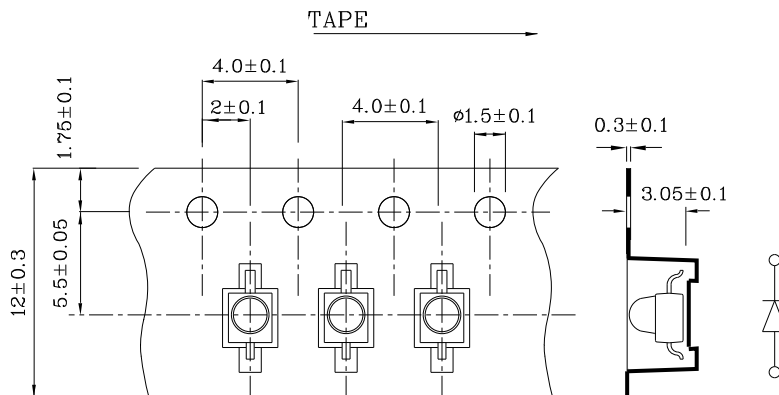

Remarks:

If special sorting is required (e.g. binning based on forward voltage, Luminous intensity / luminous flux, or wavelength), the typical accuracy of the sorting process is as follows:

1. Wavelength: +/-1nm
2. Luminous Intensity / Luminous Flux: +/-15%
3. Forward Voltage: +/-0.1V

Note: Accuracy may depend on the sorting parameters.

PACKING & LABEL SPECIFICATIONS

XZBGA46W-3

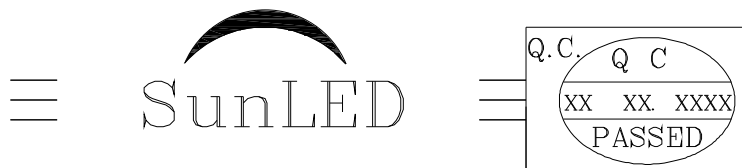
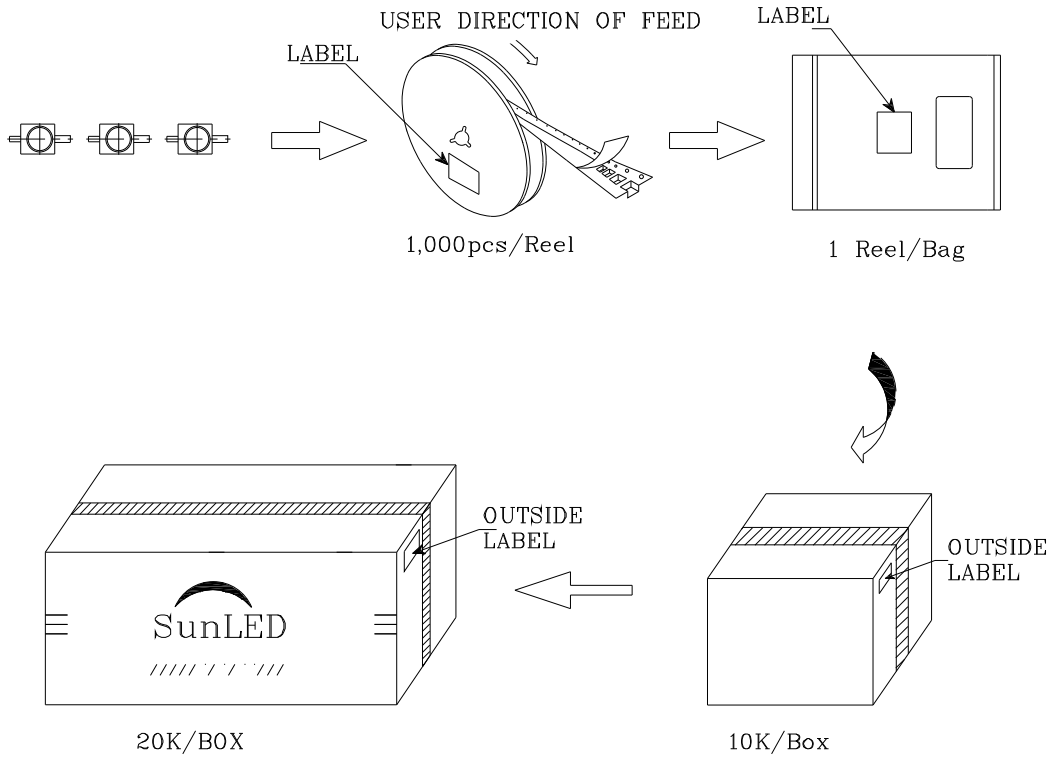

P/NO : XZxxx46x-3	
QTY : 1,000 pcs	CODE: XXX
S/N : XX	
LOT NO :	
 XXXXXXXXXXXXXXXXXXXXXXXXXX	
RoHS Compliant	