

Features

- 1.6mmX0.8mm SMT LED, 1.1mm THICKNESS.
- LOW POWER CONSUMPTION.
- WIDE VIEWING ANGLE.
- IDEAL FOR BACKLIGHT AND INDICATOR.
- VARIOUS COLORS AND LENS TYPES AVAILABLE.
- PACKAGE: 2000PCS / REEL .
- MOISTURE SENSITIVITY LEVEL : LEVEL 3.
- RoHS COMPLIANT.

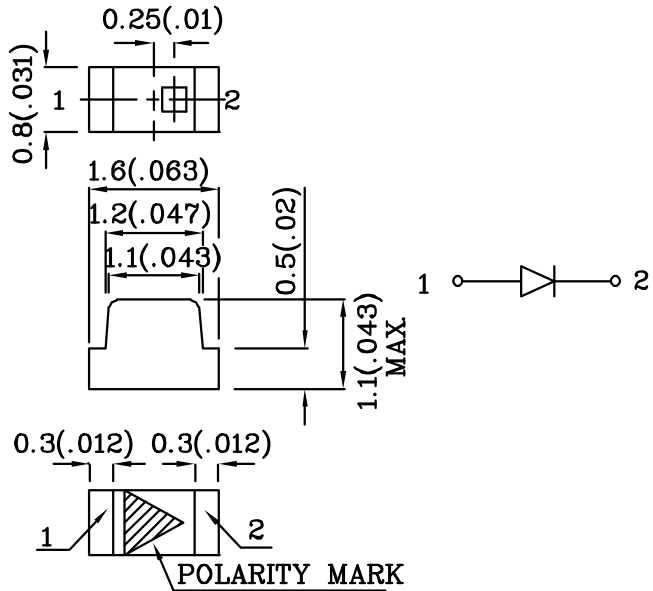

ATTENTION
OBSERVE PRECAUTIONS
FOR HANDLING
ELECTROSTATIC
DISCHARGE
SENSITIVE
DEVICES



Notes:

1. All dimensions are in millimeters (inches).
2. Tolerance is $\pm 0.1(0.004)$ unless otherwise noted.
3. Specifications are subject to change without notice.

Absolute Maximum Ratings ($T_A=25^\circ\text{C}$)		BBA (InGaN)	Unit
Reverse Voltage	V_R	5	V
Forward Current	I_F	30	mA
Forward Current (Peak) 1/10 Duty Cycle 0.1ms Pulse Width	i_{FS}	100	mA
Power Dissipation	P_T	120	mW
Operating Temperature	T_A	-40 ~ +85	°C
Storage Temperature	T_{stg}	-40 ~ +85	
Electrostatic Discharge Threshold (HBM)		1000	V

Operating Characteristics ($T_A=25^\circ\text{C}$)		BBA (InGaN)	Unit
Forward Voltage (Typ.) ($I_F=20\text{mA}$)	V_F	3.2	V
Forward Voltage (Max.) ($I_F=20\text{mA}$)	V_F	4.0	V
Reverse Current (Max.) ($V_R=5\text{V}$)	I_R	10	μA
Wavelength Of Peak Emission (Typ.) ($I_F=20\text{mA}$)	λ_P	468	nm
Wavelength Of Domi- nant Emission (Typ.) ($I_F=20\text{mA}$)	λ_D	470	nm
Spectral Line Full Width At Half-Maximum (Typ.) ($I_F=20\text{mA}$)	$\Delta\lambda$	21	nm
Capacitance (Typ.) ($V_F=0\text{V}$, $f=1\text{MHz}$)	C	100	pF

Part Number	Emitting Color	Emitting Material	Lens-color	Luminous Intensity ($I_F=20\text{mA}$) mcd		Wavelength nm λ_P	Viewing Angle $2\theta_{1/2}$
				min.	typ.		
XZBBA53W	Blue	InGaN	Water Clear	18	59	468	120°
Published Date : JAN 22,2008 Drawing No : XDSA6742 V4 Checked : B.L.LIU P.1/4							

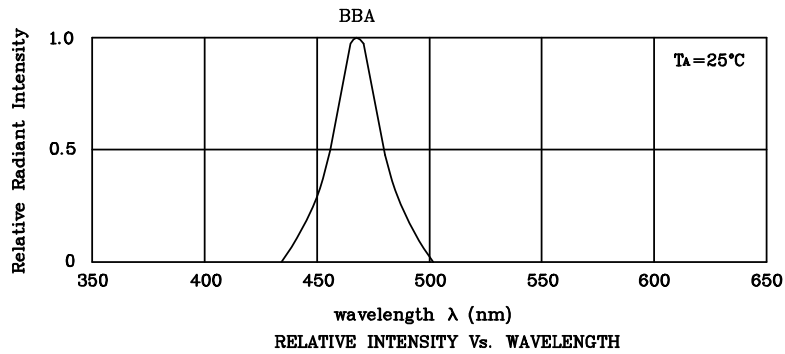

❖ BBA

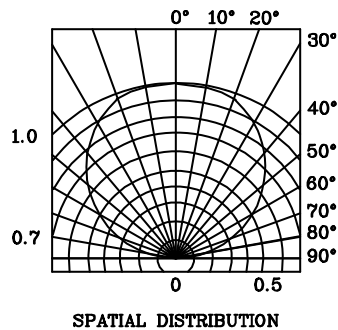
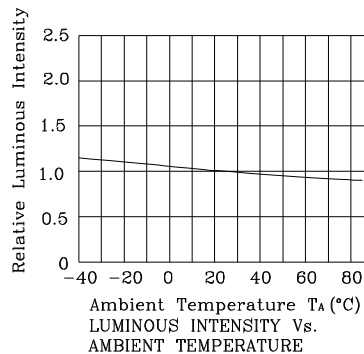
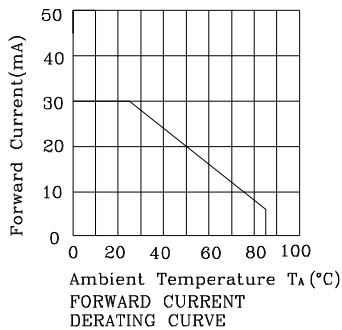
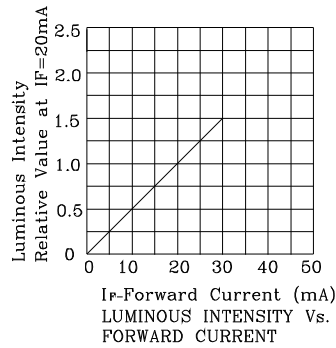
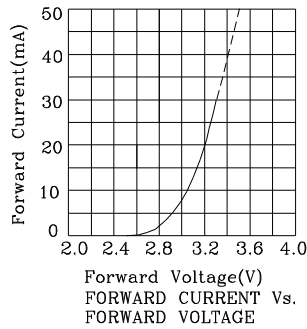

Reflow Soldering Profile For Lead-free SMT Process.

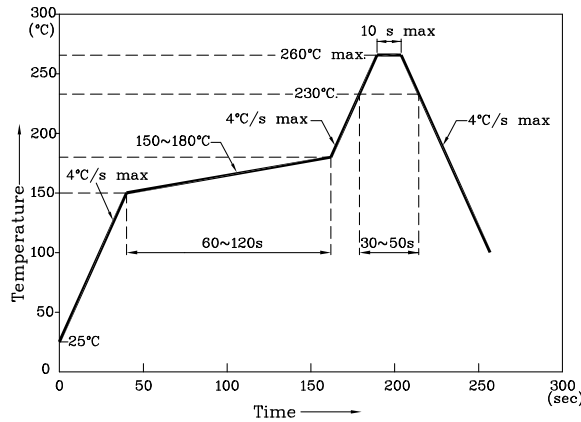

NOTES:

1. Maximum soldering temperature should not exceed 260°C.
2. Recommended reflow temperature: 145°C–260°C.
3. Do not put stress to the epoxy resin during high temperatures conditions.

❖ Recommended Soldering Pattern (Units : mm; Tolerance: ± 0.1)

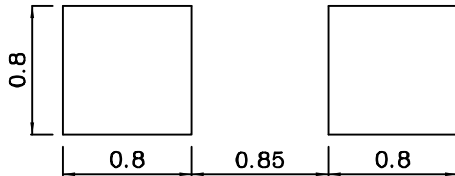

❖ The device has a single mounting surface. The device must be mounted according to the specifications.

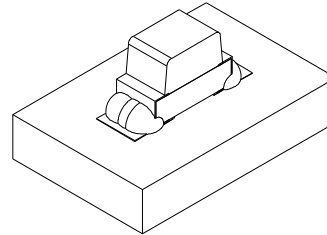

❖ Tape Specification (Units : mm)

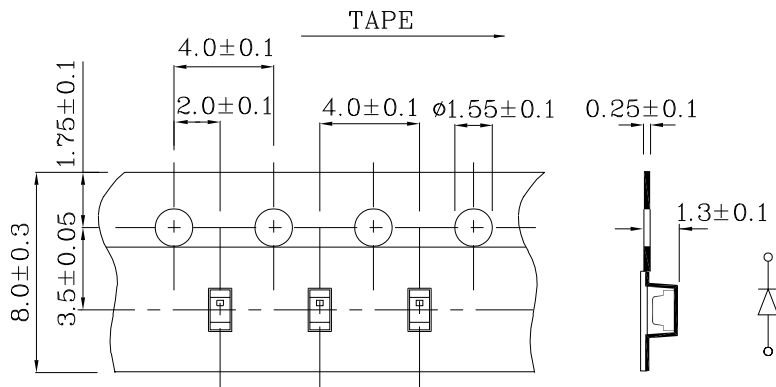

Remarks:

If special sorting is required (e.g. binning based on forward voltage, Luminous intensity / luminous flux, or wavelength), the typical accuracy of the sorting process is as follows:

1. Wavelength: +/-1nm
2. Luminous intensity / luminous flux: +/-15%
3. Forward Voltage: +/-0.1V

Note: Accuracy may depend on the sorting parameters.

PACKING & LABEL SPECIFICATIONS

XZBBA53W

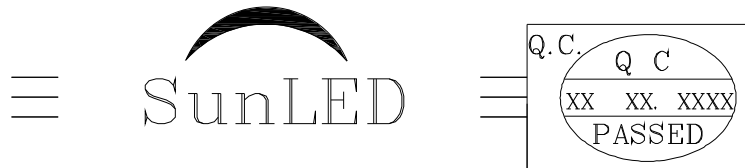
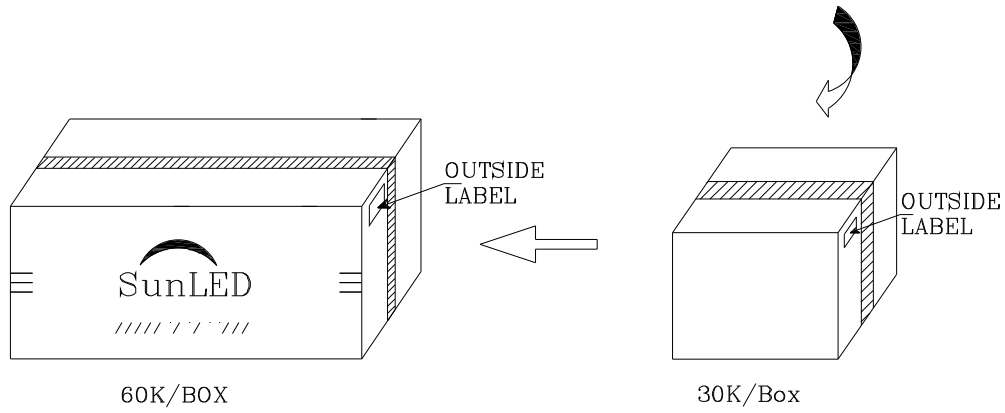
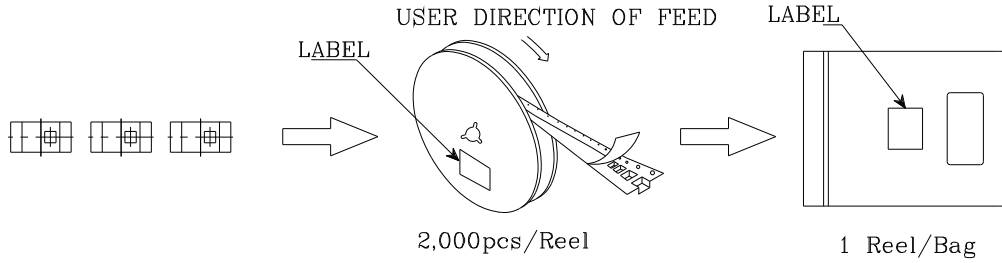

P/NO : XZxxx53x	
QTY : 2,000 pcs	CODE: XXX
S/N : XX	
LOT NO :	
 XXXXXXXXXXXXXXXXXXXXXXXX	
RoHS Compliant	