

**Features**

- 0.4 INCH CHARACTER HEIGHT.
- LOW CURRENT OPERATION.
- HIGH CONTRAST AND LIGHT OUTPUT.
- EASY MOUNTING ON P.C. BOARDS OR SOCKETS.
- CATEGORIZED FOR LUMINOUS INTENSITY.
- MECHANICALLY RUGGED.
- GRAY FACE, WHITE SEGMENT.
- PACKAGE :500PCS / REEL.
- RoHS COMPLIANT.

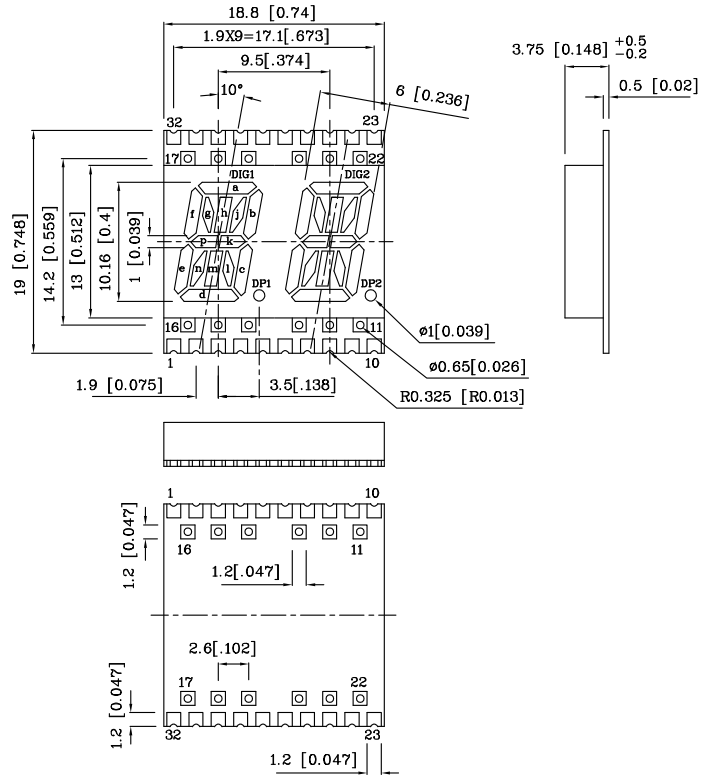
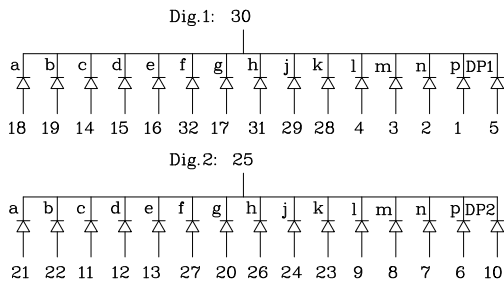

Notes:

1. All dimensions are in millimeters (inches).
2. Tolerance is ± 0.25(0.01") unless otherwise noted.

Absolute maximum ratings (TA=25°C)		UR (GaAsP/ GaP)	Unit
Reverse Voltage	V <sub>R</sub>	5	V
Forward Current	I <sub>F</sub>	30	mA
Forward Current (Peak) 1/10 Duty Cycle 0.1ms Pulse Width	i <sub>F</sub> S	160	mA
Power Dissipation	P <sub>T</sub>	105	mW
Operating Temperature	T <sub>A</sub>	-40 ~ +85	°C
Storage Temperature	T <sub>stg</sub>	-40 ~ +85	

Operating Characteristics (TA=25°C)		UR (GaAsP/ GaP)	Unit
Forward Voltage (Typ.) (I <sub>F</sub> =10mA)	V <sub>F</sub>	1.9	V
Forward Voltage (Max.) (I <sub>F</sub> =10mA)	V <sub>F</sub>	2.5	V
Reverse Current (V <sub>R</sub> =5V)	I <sub>R</sub>	10	uA
Wavelength of Peak Emission (I <sub>F</sub> =10mA)	λ <sub>P</sub>	627	nm
Wavelength of Dominant Emission (I <sub>F</sub> =10mA)	λ <sub>D</sub>	625	nm
Spectral Line Full Width At Half-Maximum (I <sub>F</sub> =10mA)	Δλ	45	nm
Capacitance (V <sub>F</sub> =0V, f=1MHz)	C	15	pF

Part Number	Emitting Color	Emitting Material	Luminous Intensity (I <sub>F</sub> =10mA) ucd		Wavelength nm λ <sub>P</sub>	Description
			min.	typ.		
XZAU10C2	Red	GaAsP/GaP	800	3190	627	Common Cathode, Rt. Hand Decimal

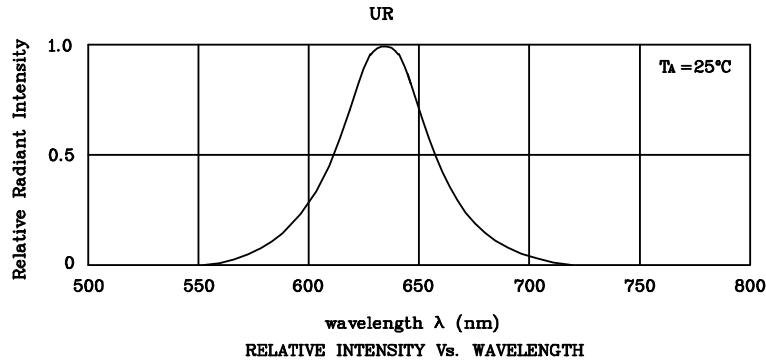

❖ UR

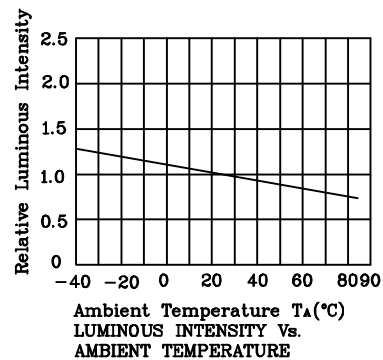
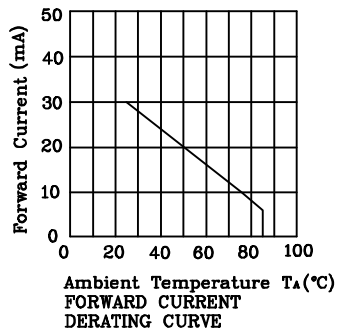
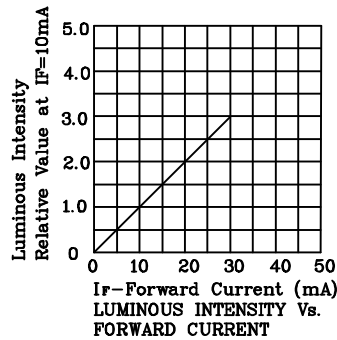
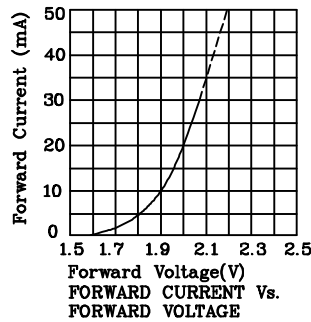

Remarks:

If special sorting is required (e.g. binning based on forward voltage, luminous intensity or wavelength), the typical accuracy of the sorting process is as follows:

1. Wavelength: +/-1nm
2. Luminous Intensity: +/-15%
3. Forward Voltage: +/-0.1V

Note: Accuracy may depend on the sorting parameters.

Reflow Soldering Profile For Lead-free SMT Process.

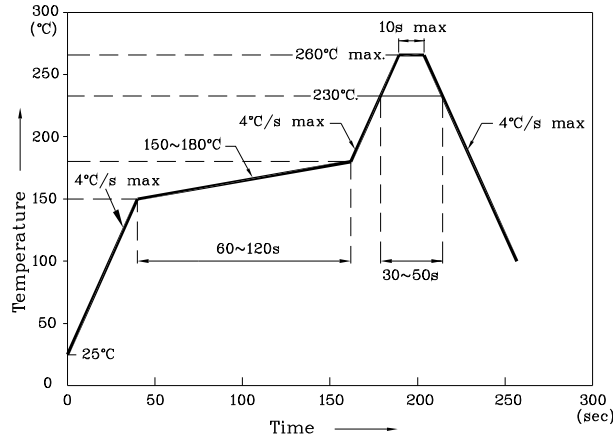

Notes:

1. Maximum soldering temperature should not exceed 260°C.
2. Recommended reflow temperature: 145°C–260°C.
3. Do not put stress to the epoxy resin during high temperatures conditions.

❖ Recommended Soldering Pattern (Units : mm;Tolerance: ± 0.15)

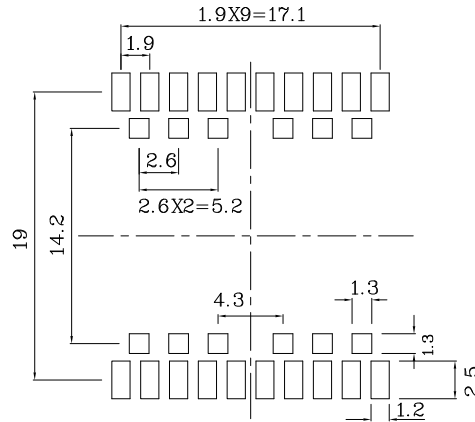

❖ Tape Specification (Units : mm)

