

Features

- 0.4 INCH CHARACTER HEIGHT.
- LOW CURRENT OPERATION.
- HIGH CONTRAST AND LIGHT OUTPUT.
- EASY MOUNTING ON P.C. BOARDS OR SOCKETS.
- CATEGORIZED FOR LUMINOUS INTENSITY.
- MECHANICALLY RUGGED.
- GRAY FACE, WHITE SEGMENT.
- PACKAGE : 800PCS / REEL.
- RoHS COMPLIANT.

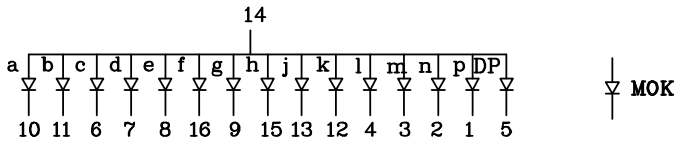
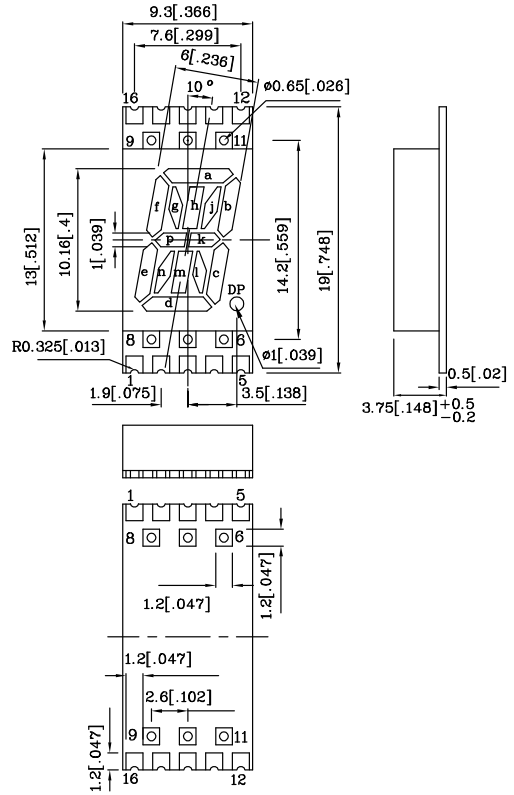

Notes:

1. All dimensions are in millimeters (inches).
2. Tolerance is $\pm 0.25(0.01")$ unless otherwise noted.

Absolute maximum ratings (TA=25°C)		MOK (InGaAlP)	Unit
Reverse Voltage	V _R	5	V
Forward Current	I _F	30	mA
Forward Current (Peak) 1/10 Duty Cycle 0.1ms Pulse Width	i _{FS}	195	mA
Power Dissipation	P _T	75	mW
Operating Temperature	T _A	-40 ~ +85	°C
Storage Temperature	T _{stg}	-40 ~ +85	

Operating Characteristics (TA=25°C)		MOK (InGaAlP)	Unit
Forward Voltage (Typ.) (I _F =10mA)	V _F	2.0	V
Forward Voltage (Max.) (I _F =10mA)	V _F	2.5	V
Reverse Current (V _R =5V)	I _R	10	uA
Wavelength of Peak Emission (I _F =10mA)	λ _P	610	nm
Wavelength of Dominant Emission (I _F =10mA)	λ _D	601	nm
Spectral Line Full Width At Half-Maximum (I _F =10mA)	Δλ	29	nm
Capacitance (V _F =0V, f=1MHz)	C	15	pF

Part Number	Emitting Color	Emitting Material	Luminous Intensity (I _F =10mA) ucd		Wavelength nm λ _P	Description
			min.	typ.		
XZAMOK10A	Orange	InGaAlP	1900	7790	610	Common Anode, Rt. Hand Decimal

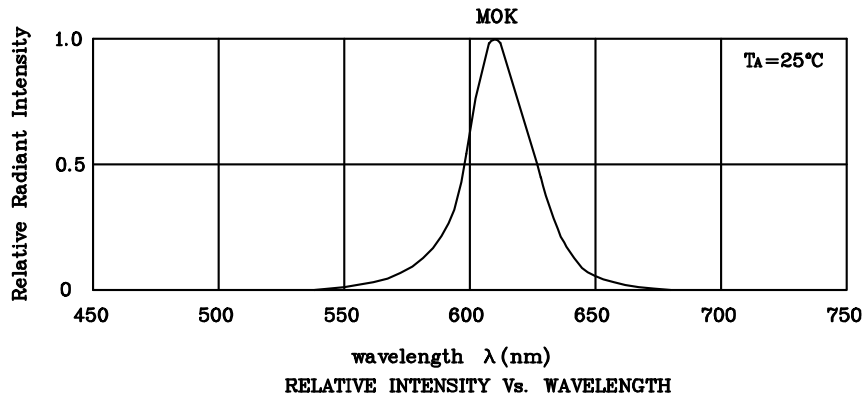

❖ **MOK**

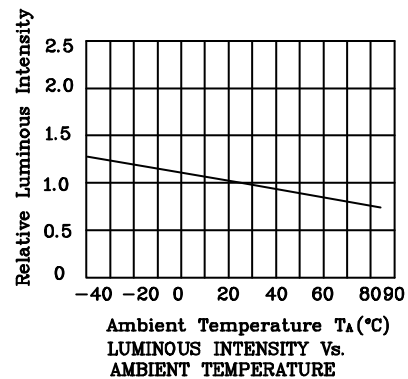
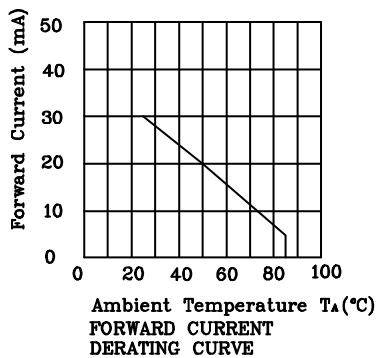
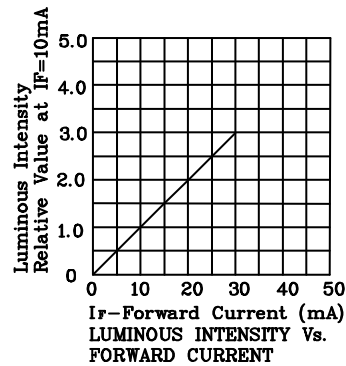
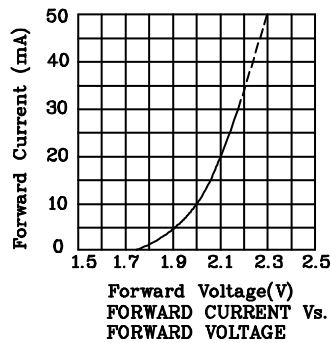

Remarks:

If special sorting is required (e.g. binning based on forward voltage, luminous intensity or wavelength), the typical accuracy of the sorting process is as follows:

1. Wavelength: +/-1nm
2. Luminous Intensity: +/-15%
3. Forward Voltage: +/-0.1V

Note: Accuracy may depend on the sorting parameters.

Reflow Soldering Profile For Lead-free SMT Process.

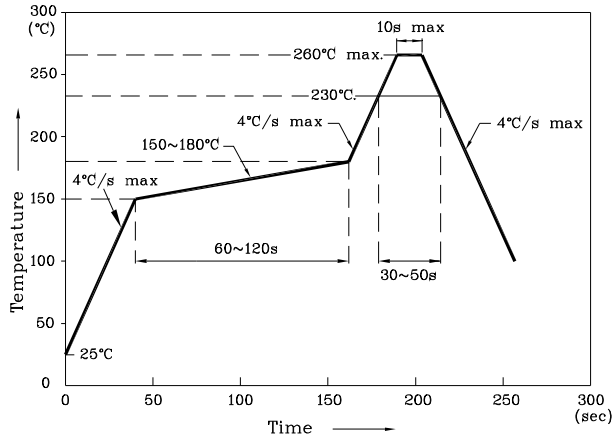

Notes:

1. Maximum soldering temperature should not exceed 260°C.
2. Recommended reflow temperature: 145°C–260°C.
3. Do not put stress to the epoxy resin during high temperatures conditions.

❖ Recommended Soldering Pattern (Units : mm;Tolerance: ± 0.15)

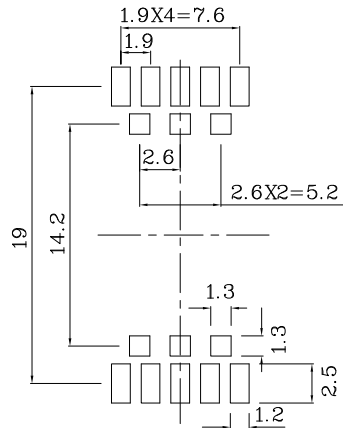

❖ Tape Specification (Units : mm)

