

Ø16mm XA Series Ø22mm XW Series

Emergency Stop Switches



<http://safety.idec.com>



Push-to-Lock, Pull/Turn-to-Reset

New Global Standard for Safety!

**ø16mm XA and ø22mm XW Series
Emergency Stop Switches**

Safe Break Action



Up to 4 Poles of Contacts



New Safety Products

Safety

World's First

Safe Break Action

When the contact block is detached from the operator, the cam directly opens the NC main contacts (contacts are off).

Detaching the Contact Block

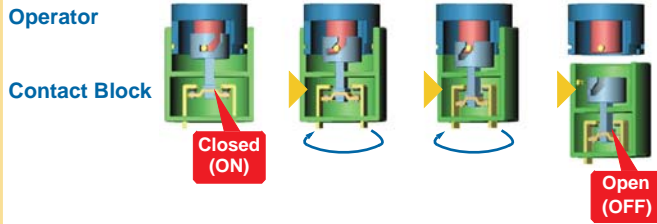

Safety Features

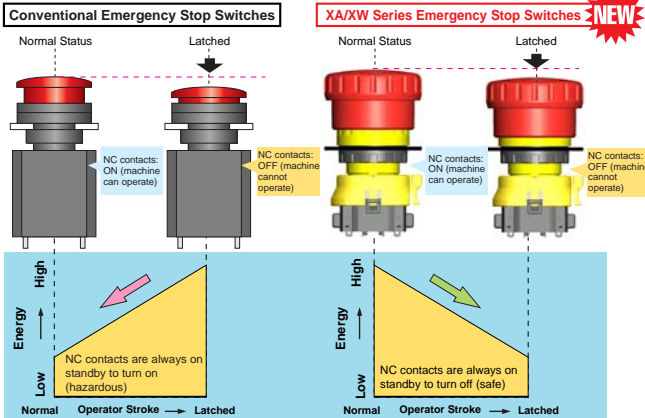

With the XA and XW emergency stop switches, the energy level of the "on" (closed) NC contacts is higher than that of the "off" (open) contacts. If the contact block falls off due to excessive shocks, the NC contacts are always inclined to turn off, thus ensuring safety by stopping the machine.

Direct Opening Action

IEC60947-5-5, 5.2, IEC60947-5-1, Annex K



Safety Lock Mechanism

IEC60947-5-5, 6.2

Compact Size

World's First

ø16 XA Series

The depth behind the panel is 27.9 mm.
Up to 4 contacts are available!

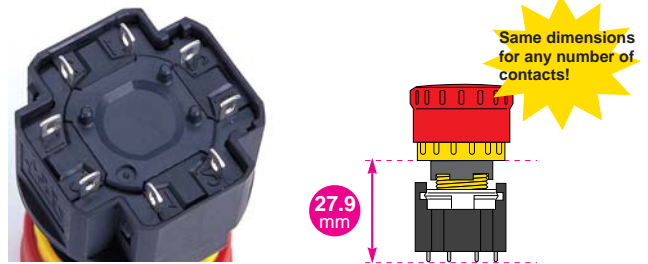

ø22 XW Series

World's Shortest

The depth behind the panel:
Solder terminal: 37.1 mm
Screw terminal: 48.7 mm
Up to 4 contacts save space.

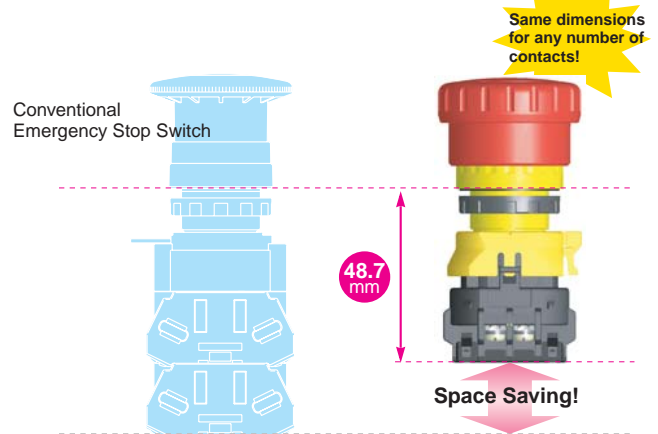

As of June, 2004

Easy Operation

Push-to-lock, Pull/Turn-to-unlatch

The XA and XW emergency stop switches can be unlatched by either pulling or turning the operator.

Unlatching by pulling



Unlatching by turning

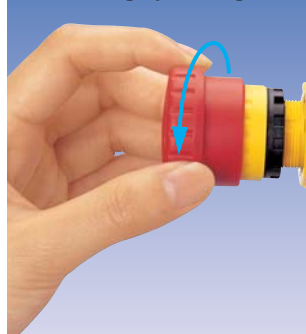

Variety

Three terminal styles



Screw Terminal

Solder Terminal

PC Board Terminal

Two button colors



Bright Red
Munsell 7.5R4.5/14

Dark Red
Munsell 5R4/12

ø16mm XA series Emergency Stop Switches

**The World's First ø16 mm, 4-contact Emergency Stop Switch.
Compact size - only 27.9 mm deep behind the panel.**

- Lead-free, RoHS compliant.
- The depth behind the panel is only 27.9 mm for 1 to 4 contacts.
- IDEC's original "Safe break action" ensures that the contacts open when the contact block is detached from the operator.
- 1 to 4NC main contacts and 1NO monitor contact
- Push-to-lock, Pull or Turn-to-reset operator
- Direct opening action mechanism (IEC60947-5-5, 5.2, IEC60947-5-1, Annex K)
- Safety lock mechanism (IEC60947-5-5, 6.2)
- Degree of protection IP65 (IEC60529)
- Two operator sizes: ø29 and ø40 mm
- Dark red (Munsell 5R4/12) or bright red (Munsell 7.5R4.5/14) colors are available for the operator of emergency stop switches, and gray for stop switch operators.
- UL, c-UL approved. EN compliant



Standard	Mark	Approval Organization/ File No.
UL508 CSA C22.2 No. 14		UL/c-UL File No. E68961
EN60947-5-1 EN60947-5-5 (Note)		TÜV Product Service
		Self-declaration (European Commission's Low Voltage Directive)

Note: Except for stop switches (operator color: gray).

Contact Ratings (NC main contacts/NO monitor contact)

Rated Insulation Voltage (Ui)		300V				
Rated Current (Ith)		5A				
Rated Operating Voltage (Ue)		30V	125V	250V		
Rated Operating Current	Main Contacts	AC 50/60 Hz	Resistive Load (AC-12)	–	3A	3A
			Inductive Load (AC-15)	–	1.5A	1.5A
	DC	Resistive Load (DC-12)	2A	0.4A	0.2A	
		Inductive Load (DC-13)	1A	0.22A	0.1A	
Monitor Contacts	AC 50/60 Hz	Resistive Load (AC-12)	–	1.2A	0.6A	
		Inductive Load (AC-14)	–	0.6A	0.3A	
	DC	Resistive Load (DC-12)	2A	0.4A	0.2A	
		Inductive Load (DC-13)	1A	0.22A	0.1A	

- Minimum applicable load: 5V AC/DC, 1 mA (reference value) (Operating area may vary according to the operating conditions and load types.)
- The rated operating currents are measured at resistive/inductive load types specified in JIS C8201-5-1.

Specifications





Applicable Standards	IEC60947-5-1, EN60947-5-1 IEC60947-5-5 (Note), EN60947-5-5 (Note) JIS C8201-5-1, UL508, CSA C22.2 No. 14
Operating Temperature	–25 to +60°C (no freezing)
Operating Humidity	45 to 85% RH (no condensation)
Storage Temperature	–45 to +80°C
Operating Force	Push to lock: 10.5N Pull to reset: 10N Turn to reset: 0.16 N·m
Minimum Force Required for Direct Opening Action	60N
Minimum Operator Stroke Required for Direct Opening Action	4.0 mm
Maximum Operator Stroke	4.5 mm
Contact Resistance	50 mΩ maximum (initial value)
Insulation Resistance	100 MΩ minimum (500V DC megger)
Overvoltage Category	II
Impulse Withstand Voltage	2.5 kV
Pollution Degree	3
Operation Frequency	900 operations/hour
Shock Resistance	Operating extremes: 150 m/s ² Damage limits: 1000 m/s ²
Vibration Resistance	Operating extremes: 10 to 500 Hz, amplitude 0.35 mm acceleration 50 m/s ² Damage limits: 10 to 500 Hz, amplitude 0.35 mm acceleration 50 m/s ²
Mechanical Life	250,000 operations minimum
Electrical Life	100,000 operations minimum 250,000 operations minimum (24V AC/DC, 100 mA)
Degree of Protection	IP65 (IEC60529)
Short-circuit Protection	250V/10A fuse (Type aM, IEC60269-1/IEC60269-2)
Conditional Short-circuit Current	1000A
Terminal Style	Solder terminal, PC Board terminal
Recommended Tightening Torque for Locking Ring	0.88 N·m
Connectable Cable	1.25 mm ² maximum (AWG16 maximum)
Soldering Conditions	20W/5 seconds maximum, or 260°C/3 seconds maximum
Weight	ø29 mm type: 23 g, ø40 mm type: 28 g

Note: Except for stop switches (operator color: gray).

ø16mm XA series Emergency Stop Switches

Types

Solder Terminal/PC Board Terminal Types

Appearance	NC Main Contact	NO Monitor Contact	Type No.		Operator Color Code
			Terminal Style		
			Solder Terminal	PC Board Terminal	
 	1NC	—	XA1E-BV301*	XA1E-BV301V*	R: Dark red RH: Bright red
	2NC	—	XA1E-BV302*	XA1E-BV302V*	
	3NC	—	XA1E-BV303*	XA1E-BV303V*	
	4NC	—	XA1E-BV304*	XA1E-BV304V*	
	1NC	1NO	XA1E-BV311*	XA1E-BV311V*	
	2NC	1NO	XA1E-BV312*	XA1E-BV312V*	
	3NC	1NO	XA1E-BV313*	XA1E-BV313V*	
 	1NC	—	XA1E-BV401*	XA1E-BV401V*	
	2NC	—	XA1E-BV402*	XA1E-BV402V*	
	3NC	—	XA1E-BV403*	XA1E-BV403V*	
	4NC	—	XA1E-BV404*	XA1E-BV404V*	
	1NC	1NO	XA1E-BV411*	XA1E-BV411V*	
	2NC	1NO	XA1E-BV412*	XA1E-BV412V*	
	3NC	1NO	XA1E-BV413*	XA1E-BV413V*	

- Specify a color code in place of * in the Type No.
- Terminal cover (XA9Z-VL2) is ordered separately.

Stop Switches (operator color: gray)

Some mobile teaching pendants are easily detachable from the system, and stop switches, not emergency stop switches, are required on such pendants. IDEC's gray-colored stop switches avoid the confusion of emergency stop switches and stop switches.



Types

• Stop Switches

NC Main Contacts	NO Monitor Contacts	Type No.	
		Terminal Style	
		Solder Terminal	PC Board Terminal
1NC	—	XA1E-BV301N	XA1E-BV301VN
2NC	—	XA1E-BV302N	XA1E-BV302VN
3NC	—	XA1E-BV303N	XA1E-BV303VN
4NC	—	XA1E-BV304N	XA1E-BV304VN
1NC	1NO	XA1E-BV311N	XA1E-BV311VN
2NC	1NO	XA1E-BV312N	XA1E-BV312VN
3NC	1NO	XA1E-BV313N	XA1E-BV313VN

- Operator is ø29 mm and gray-colored (code: N).

ø16mm XA series Emergency Stop Switches

Dimensions

• ø29mm Operator

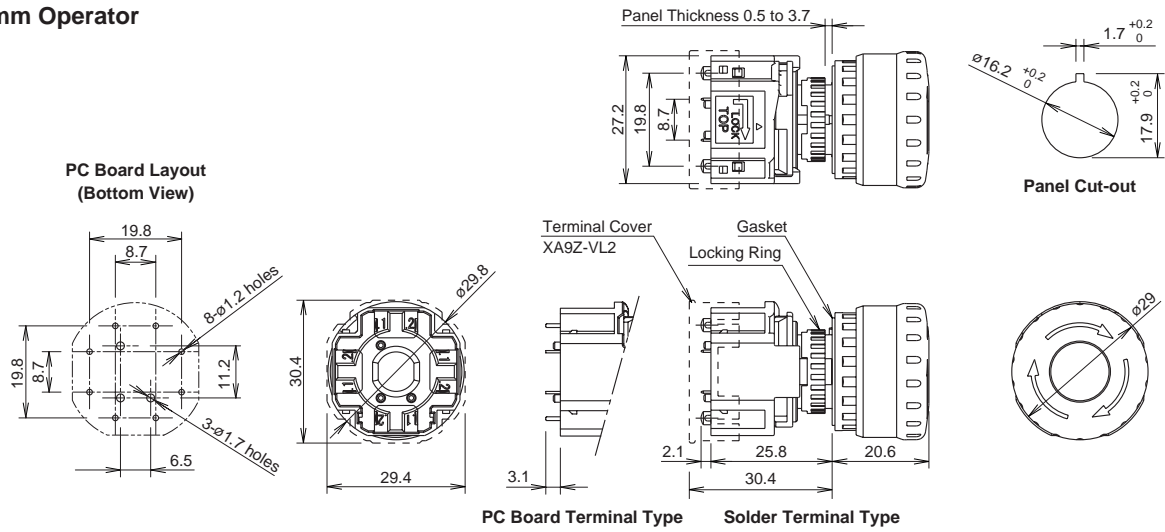

• ø40mm Operator

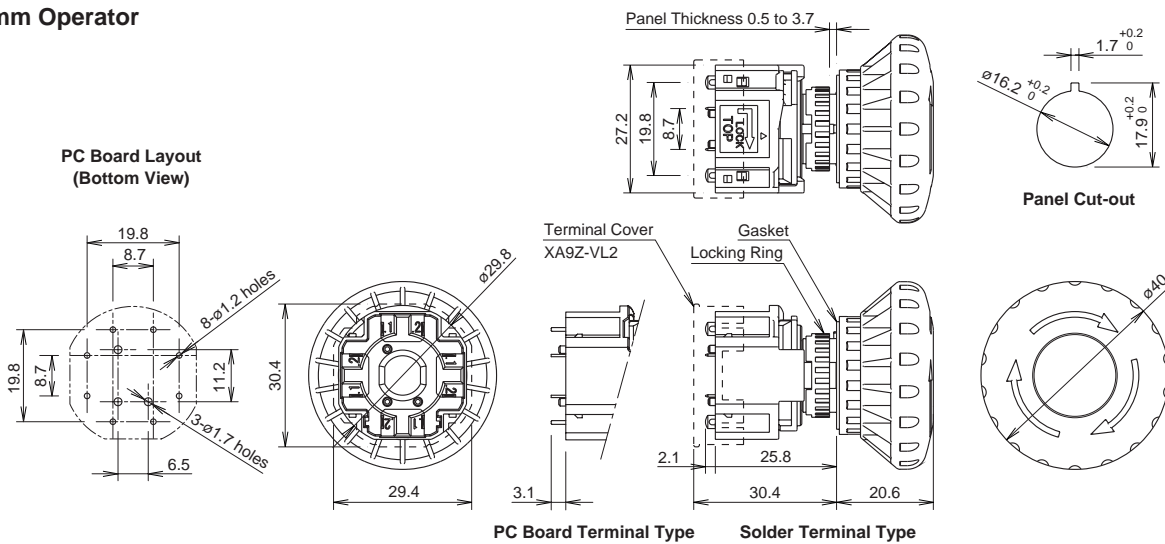

All dimensions in mm.

Mounting Hole Layout

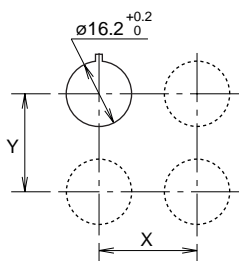

	X	Y
XA1E-BV3	40 mm minimum	
XA1E-BV4	50 mm minimum	

• The values shown above are the minimum dimensions for mounting with other ø16 mm pushbuttons. For other control units of different sizes and styles, determine the values according to the dimensions, operation, and wiring convenience.

Terminal Arrangement (Bottom View)

• NC main contacts only

NC main contacts: Terminals 1-2

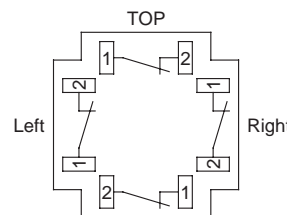

1NC: Terminals on right
2NC: Terminals on right and left
3NC: Terminals on right, left, and top

• With NO monitor contacts

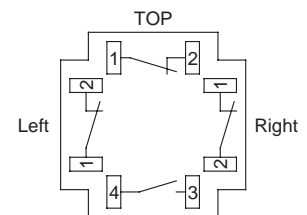

NC main contacts: Terminals 1-2
NO monitor contacts: Terminals 3-4



1NC: Terminals on top
2NC: Terminals on right and left

ø16mm XA series Emergency Stop Switches

Accessories

Description & Appearance	Material	Type No.	Ordering Type No.	Package Quantity	Remarks
Ring Wrench 	Metal (nickel-plated brass)	MT-001	MT-001	1	<ul style="list-style-type: none"> Used to tighten the locking ring when installing the XA emergency stop switch onto a panel. The recommended tightening torque is 0.88 N·m at maximum.
Locking Ring 	Plastic	HA9Z-LN	HA9Z-LNPN10	10	<ul style="list-style-type: none"> Black
Terminal Cover 	PBT	XA9Z-VL2	XA9Z-VL2PN02	2	<ul style="list-style-type: none"> White Used for solder terminals. Also applicable to the XW series.

Nameplates

Description	Legend	Type No.	Material	Plate Color	Legend Color
For ø29mm Operator	(blank)	HAAV-0	Polyamide	Yellow	Black
	EMERGENCY STOP	HAAV-27			
For ø40mm Operator	(blank)	HAAV4-0			
	EMERGENCY STOP	HAAV4-27			

• For ø29mm Operator

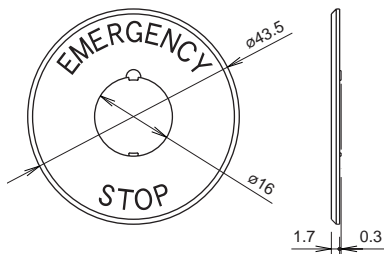

• Panel thickness when using the nameplate: 0.5 to 2 mm

• For ø40mm Operator

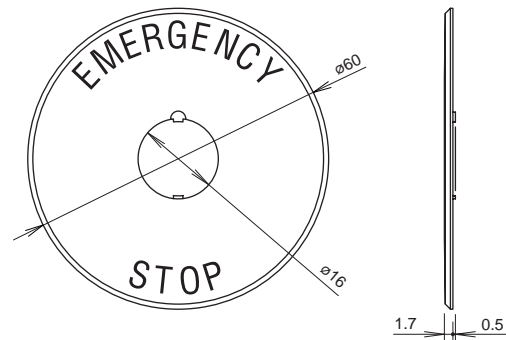

• Panel thickness when using the nameplate: 0.5 to 2 mm

All dimensions in mm.

ø16mm XA series Emergency Stop Switches

Operating Instructions

Removing the Contact Block

First unlock the operator button. While pushing up the white bayonet ring, using a small screwdriver (width: 2.5 to 3 mm) if necessary, turn the contact block counterclockwise and pull out. **Do not exert excessive force when using a screwdriver, otherwise the bayonet ring may be damaged.**

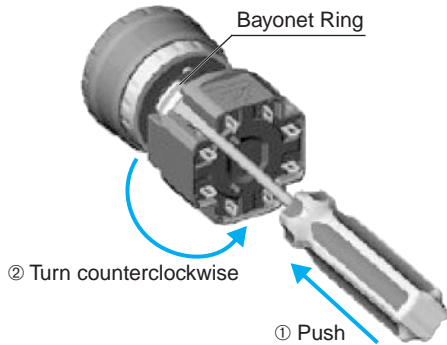

• Notes for Removing the Contact Block

1. When the contact block is removed, the monitor contact (NO contact) is closed.
2. While removing the contact block, do not exert excessive force, otherwise the switch may be damaged.

Panel Mounting

Remove the locking ring from the operator and check that the rubber gasket is in place. Insert the operator from panel front into the panel hole. Face the side with the anti-rotation protrusion on the operator upward, and tighten the locking ring.

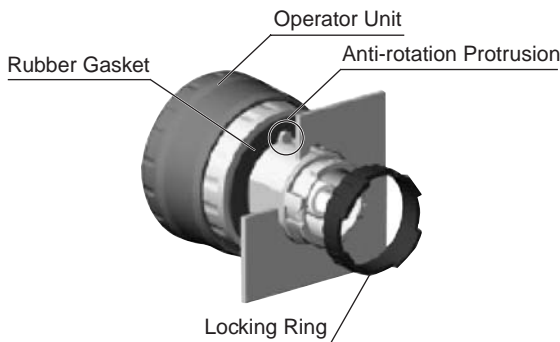

• Notes for Panel Mounting

To mount the XA emergency stop switches onto a panel, tighten the locking ring to a tightening torque of 0.88 N·m maximum using ring wrench MT-001. Do not use pliers. Do not exert excessive force, otherwise the locking ring may be damaged.

Installing the Contact Block

First turn the bayonet ring to the unlocked position.

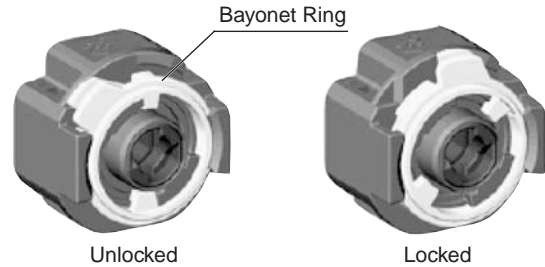

Align the small ▲ marking on the edge of the operator base with the TOP marking on the contact block. Press the contact block onto the operator and turn the contact block clockwise until the bayonet ring clicks.

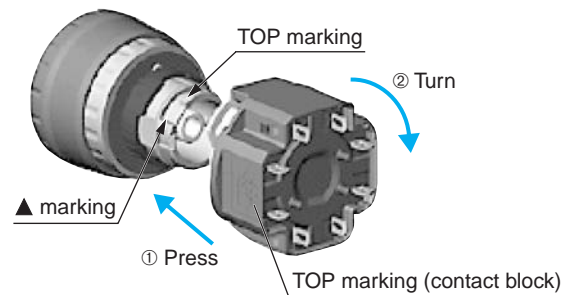

• Notes for Installing the Contact Block

Check that the contact block is securely installed on the operator. When the emergency stop switch is properly assembled, the bayonet ring is in place as shown below.

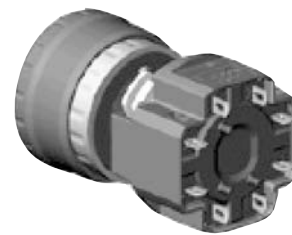

ø16mm XA series Emergency Stop Switches

Operating Instructions

Wiring

1. The applicable wire size is 1.25 mm² maximum.
2. Solder the terminals using a 20W soldering iron within 5 seconds, or at 260°C within 3 seconds. Do not apply external force. Make sure that the soldering iron touches the terminals only. When wiring, do not apply tensile force on the terminals.
3. Use a non-corrosive rosin flux.
4. Because the terminal spacing is narrow, use protective tubes or heat shrinkable tubes to avoid burning of wire coating or short circuit.

• PC Board Terminal Type

1. When mounting a contact block on a PC board, provide sufficient rotating space for the PC board when installing and removing the contact block.
2. When mounting an XA emergency stop switch on a PC board, make sure that the operator is securely installed.

• About PC Board and Circuit Design

1. Use PC boards made of glass epoxy copper-clad laminated sheets of 1.6 mm in thickness, with double-sided through hole.
2. PC boards and circuits must withstand rated voltage and current, including the instantaneous current and voltage at switching.
3. The minimum applicable load is 5V AC/DC, 1 mA. This value may vary according to the operating environment and load.
4. Within the 2.8* mm areas shown in the figure below, terminals touch the PC board, resulting in possible short circuit on the printed circuit. When designing a PC board pattern, take this possibility into consideration.

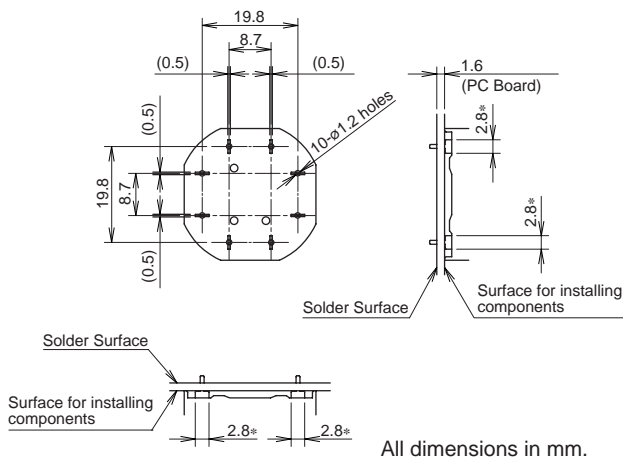

• Installing Insulation Terminal Cover

To install the terminal cover (XA9Z-VL2), align the TOP marking on the terminal cover with TOP marking on the contact block, and press the terminal cover toward the contact block.

Note: For wiring, insert the wires into the holes in the terminal cover before soldering.

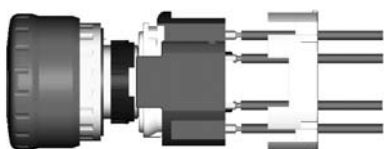

Contact Bounce

When the button is reset by pulling or turning, the NC main contacts will bounce. When pressing the button, the NO monitor contacts will bounce.

When designing a control circuit, take the contact bounce time into consideration (reference value: 20 ms).

Nameplate

When anti-rotation is not required, remove the projection from the nameplate using pliers.

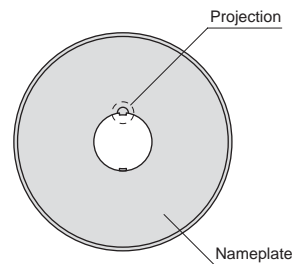

Handling

Do not expose the switch to excessive shock and vibration, otherwise the switch may be deformed or damaged, causing malfunction or operation failure.

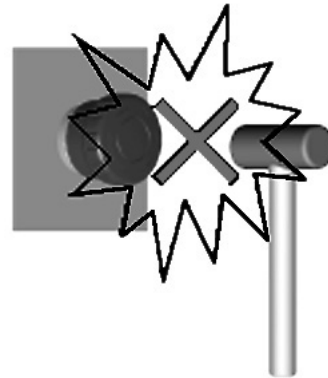

ø22mm XW series Emergency Stop Switches

ø22 mm, 4-contact Emergency Stop Switch.

Compact size - only 37.1 mm deep behind the panel (screw terminal type 48.7 mm with terminal cover).

- Lead-free, RoHS compliant.
- The depth behind the panel is only 37.1 mm for 1 to 4 contacts (screw terminal type 48.7 mm with terminal cover).
- The same depth behind the panel for illuminated and non-illuminated switches.
- IDEC's original "Safe break action" ensures that the contacts open when the contact block is detached from the operator.
- 1 to 4NC main contacts and 1 or 2NO monitor contact
- Push-to-lock, Pull or Turn-to-reset operator
- Direct opening action mechanism (IEC60947-5-5, 5.2, IEC60947-5-1, Annex K)
- Safety lock mechanism (IEC60947-5-5, 6.2)
- Degree of protection IP65 (IEC60529)
- Screw terminal type is finger-safe (IP20).
- Two operator sizes: ø40 and ø60 mm
- Dark red (Munsell 5R4/12) or bright red (Munsell 7.5R4.5/14) colors are available for the non-illuminated operator.
- Push-ON illumination type available (operator size: ø60)
- UL, c-UL approved. EN compliant



Standard	Mark	Approval Organization/ File No.
UL508 CSA C22.2 No. 14		UL/c-UL File No. E68961 (solder terminal, PC board terminal types)
		UL/c-UL Listing (screw terminal type only)
EN60947-5-1 EN60947-5-5		TÜV Product Service
		Self-declaration (European Commission's Low Voltage Directive)

Contact Ratings (NC main contacts/NO monitor contact)

Rated Insulation Voltage (Ui)		Screw Terminal Type	250V			
Rated Insulation Voltage (Ui)		Solder Terminal Type	300V			
Rated Insulation Voltage (Ui)		PC Board Terminal Type	300V			
Rated Current (Ith)		5A				
Rated Operating Voltage (Ue)		30V	125V	250V		
Rated Operating Current	Main Contacts	AC 50/60 Hz	Resistive Load (AC-12)	–	5A (Note 1)	3A
			Inductive Load (AC-15)	–	3A (Note 2)	1.5A
		DC	Resistive Load (DC-12)	2A	0.4A	0.2A
			Inductive Load (DC-13)	1A	0.22A	0.1A
	Monitor Contacts	AC 50/60 Hz	Resistive Load (AC-12)	–	1.2A	0.6A
			Inductive Load (AC-14)	–	0.6A	0.3A
DC		Resistive Load (DC-12)	2A	0.4A	0.2A	
		Inductive Load (DC-13)	1A	0.22A	0.1A	

- Minimum applicable load: 5V AC/DC, 1 mA (reference value) (Operating area may vary according to the operating conditions and load types.)
- The rated operating currents are measured at resistive/inductive load types specified in JIS C8201-5-1.

Note 1: Solder terminal/PC board terminal types: 3A
Note 2: Solder terminal/PC board terminal types: 1.5A

Illumination Ratings





Rated Voltage	Operating Voltage	Rated Current
24V AC/DC	24V AC/DC ±10%	15 mA

Specifications

Applicable Standards	IEC60947-5-1, EN60947-5-1 IEC60947-5-5 (Note), EN60947-5-5 (Note) JIS C8201-5-1, UL508, CSA C22.2 No. 14
Operating Temperature	Non-illuminated: –25 to +60°C (no freezing) LED illuminated: –25 to +55°C (no freezing)
Operating Humidity	45 to 85% RH (no condensation)
Storage Temperature	–45 to +80°C
Operating Force	Push to lock: 32N Pull to reset: 21N Turn to reset: 0.27 N·m
Minimum Force Required for Direct Opening Action	80N
Minimum Operator Stroke Required for Direct Opening Action	4.0 mm
Maximum Operator Stroke	4.5 mm
Contact Resistance	50 mΩ maximum (initial value)
Insulation Resistance	100 MΩ minimum (500V DC megger)
Overvoltage Category	II
Impulse Withstand Voltage	2.5 kV
Pollution Degree	3
Operation Frequency	900 operations/hour
Shock Resistance	Operating extremes: 150 m/s ² Damage limits: 1000 m/s ²
Vibration Resistance	Operating extremes: 10 to 500 Hz, amplitude 0.35 mm, acceleration 50 m/s ² Damage limits: 10 to 500 Hz, amplitude 0.35 mm, acceleration 50 m/s ²
Mechanical Life	250,000 operations minimum
Electrical Life	100,000 operations minimum 250,000 operations minimum (24V AC/DC, 100 mA)
Degree of Protection	IP65 (IEC60529)
Short-circuit Protection	250V/10A fuse (Type aM, IEC60269-1/IEC60269-2)
Conditional Short-circuit Current	1000A
Terminal Style	Solder terminal, PC board terminal, M3 screw terminal
Recommended Tightening Torque for Locking Ring	2.0 N·m
Connectable Cable	Screw terminal type: 0.75 to 1.25 mm ² (AWG18 to 16) Solder terminal / PC board terminal types: 1.25 mm ² maximum (AWG16 maximum)
Soldering Conditions	20W/5 seconds maximum, or 260°C/3 seconds maximum
Recommended Tightening Torque for Terminal Screw	0.6 to 1.0 N·m
Weight	ø40 mm type: 72 g ø60 mm type: 81 g



ø22mm XW series Emergency Stop Switches

Non-illuminated Screw Terminal Types

Appearance	NC Main Contact	NO Monitor Contact	Type No.		Operator Color Code
			IP20	w/Terminal Cover	
ø40mm Operator  	1NC	—	XW1E-BV401MF*	XW1E-BV401M*	R: Dark red RH: Bright red
	2NC	—	XW1E-BV402MF*	XW1E-BV402M*	
	3NC	—	XW1E-BV403MF*	XW1E-BV403M*	
	4NC	—	XW1E-BV404MF*	XW1E-BV404M*	
	1NC	1NO	XW1E-BV411MF*	XW1E-BV411M*	
	2NC	1NO	XW1E-BV412MF*	XW1E-BV412M*	
	3NC	1NO	XW1E-BV413MF*	XW1E-BV413M*	
	2NC	2NO	XW1E-BV422MF*	XW1E-BV422M*	
ø60mm Operator  	1NC	—	XW1E-BV501MF*	XW1E-BV501M*	
	2NC	—	XW1E-BV502MF*	XW1E-BV502M*	
	3NC	—	XW1E-BV503MF*	XW1E-BV503M*	
	4NC	—	XW1E-BV504MF*	XW1E-BV504M*	
	1NC	1NO	XW1E-BV511MF*	XW1E-BV511M*	
	2NC	1NO	XW1E-BV512MF*	XW1E-BV512M*	
	3NC	1NO	XW1E-BV513MF*	XW1E-BV513M*	
	2NC	2NO	XW1E-BV522MF*	XW1E-BV522M*	

- Specify a color code in place of * in the Type No.
- IP20 types can be connected to solid wires only.



Non-illuminated Solder Terminal/PC Board Terminal Types

Appearance	NC Main Contact	NO Monitor Contact	Type No.		Operator Color Code
			Terminal Style		
			Solder Terminal	PC Board Terminal	
ø40mm Operator  	1NC	—	XW1E-BV401*	XW1E-BV401V*	R: Dark red RH: Bright red
	2NC	—	XW1E-BV402*	XW1E-BV402V*	
	3NC	—	XW1E-BV403*	XW1E-BV403V*	
	4NC	—	XW1E-BV404*	XW1E-BV404V*	
	1NC	1NO	XW1E-BV411*	XW1E-BV411V*	
	2NC	1NO	XW1E-BV412*	XW1E-BV412V*	
	3NC	1NO	XW1E-BV413*	XW1E-BV413V*	
	2NC	2NO	XW1E-BV422*	—	

- Specify a color code in place of * in the Type No.
- Terminal cover (XA9Z-VL2) is ordered separately.



ø22mm XW series Emergency Stop Switches

LED Illuminated Screw Terminal Types

Appearance	Illumination Type	Rated Voltage	NC Main Contact	NO Monitor Contact	Type No.	
					IP20	w/Terminal Cover
 	LED	24V AC/DC	1NC	—	XW1E-LV401Q4MFR	XW1E-LV401Q4MR
			2NC	—	XW1E-LV402Q4MFR	XW1E-LV402Q4MR
			3NC	—	XW1E-LV403Q4MFR	XW1E-LV403Q4MR
			4NC	—	XW1E-LV404Q4MFR	XW1E-LV404Q4MR
			1NC	1NO	XW1E-LV411Q4MFR	XW1E-LV411Q4MR
			2NC	1NO	XW1E-LV412Q4MFR	XW1E-LV412Q4MR
			3NC	1NO	XW1E-LV413Q4MFR	XW1E-LV413Q4MR
			2NC	2NO	XW1E-LV422Q4MFR	XW1E-LV422Q4MR



- The operator color is red only.
- IP20 types can be connected to solid wires only.

LED Illuminated Solder Terminal/PC Board Terminal Types

Appearance	Illumination Type	Rated Voltage	NC Main Contact	NO Monitor Contact	Type No.	
					Terminal Style	
					Solder Terminal	PC Board Terminal
 	LED	24V AC/DC	1NC	—	XW1E-LV401Q4R	XW1E-LV401Q4VR
			2NC	—	XW1E-LV402Q4R	XW1E-LV402Q4VR
			3NC	—	XW1E-LV403Q4R	XW1E-LV403Q4VR
			4NC	—	XW1E-LV404Q4R	XW1E-LV404Q4VR
			1NC	1NO	XW1E-LV411Q4R	XW1E-LV411Q4VR
			2NC	1NO	XW1E-LV412Q4R	XW1E-LV412Q4VR
			3NC	1NO	XW1E-LV413Q4R	XW1E-LV413Q4VR
			2NC	2NO	XW1E-LV422Q4R	—

- The operator color is red only.
- Terminal cover (XA9Z-VL2) is ordered separately.

Push-ON LED Illuminated Screw Terminal Types

Appearance	Illumination Type	Rated Voltage	NC Main Contact	NO Monitor Contact	Type No.	
					IP20	w/Terminal Cover
 	LED	24V AC/DC	3NC	—	XW1E-TV403Q4MFR	XW1E-TV403Q4MR
			2NC	1NO	XW1E-TV412Q4MFR	XW1E-TV412Q4MR

- The operator color is red only.
- Push-ON types is illuminated when the operator is latched, and turns off when reset.
- IP20 types can be connected to solid wires only.

ø22mm XW series Emergency Stop Switches

Dimensions (Non-Illuminated)

• Screw Terminal Type (IP20)

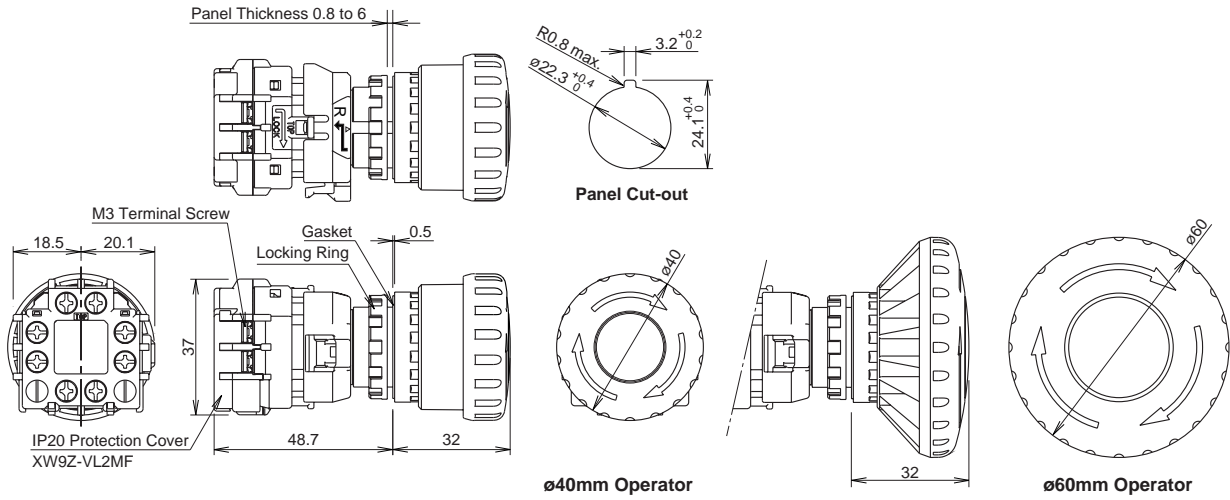

• Screw Terminal Type (w/terminal cover)

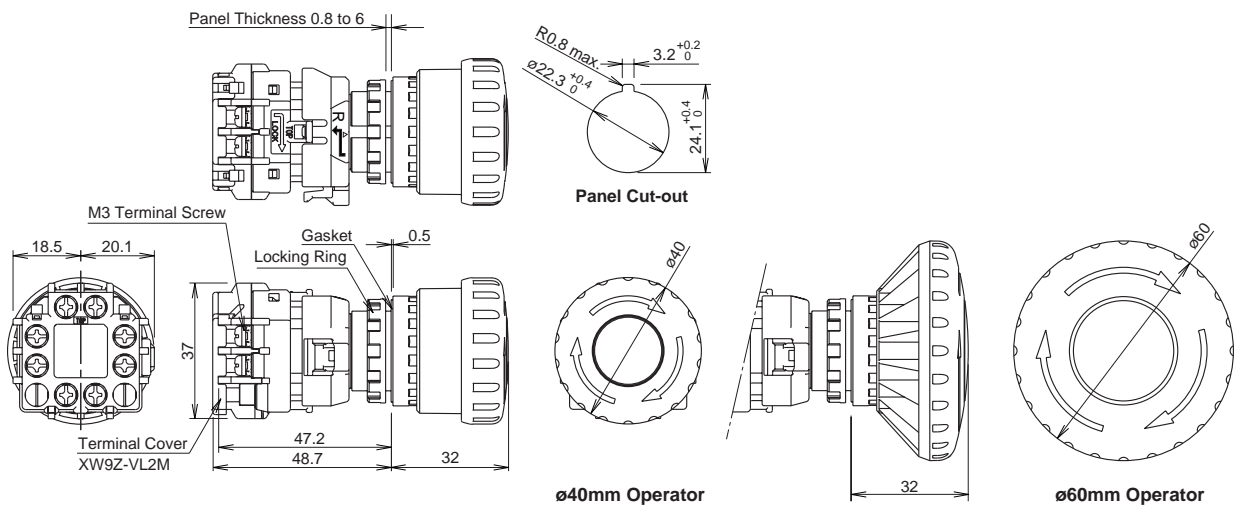

• Solder Terminal and PC Board Terminal Types ø40mm Operator

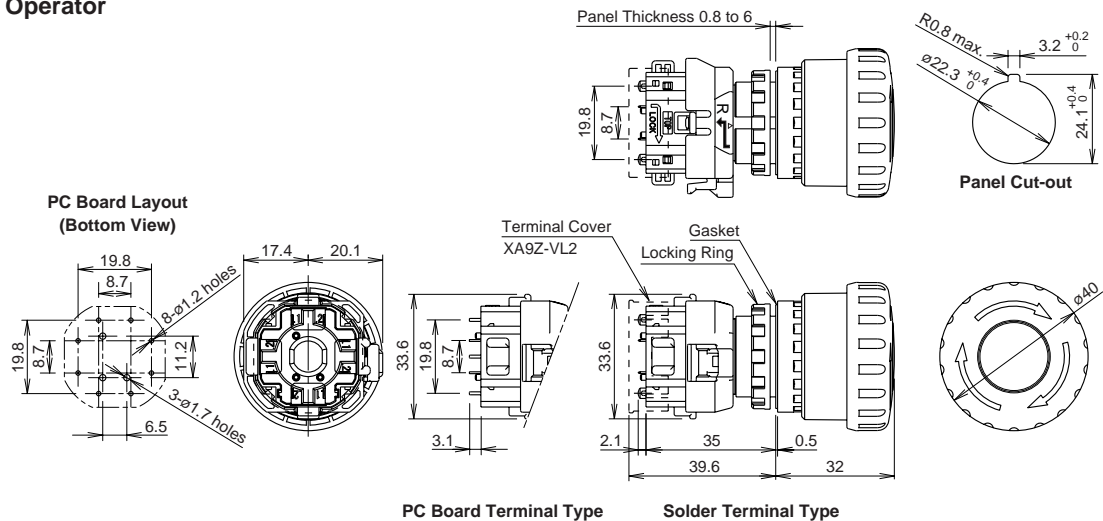

All dimensions in mm.

ø22mm XW series Emergency Stop Switches

Dimensions (Illuminated)

- Screw Terminal (IP20) LED Illuminated Type
ø40mm Operator

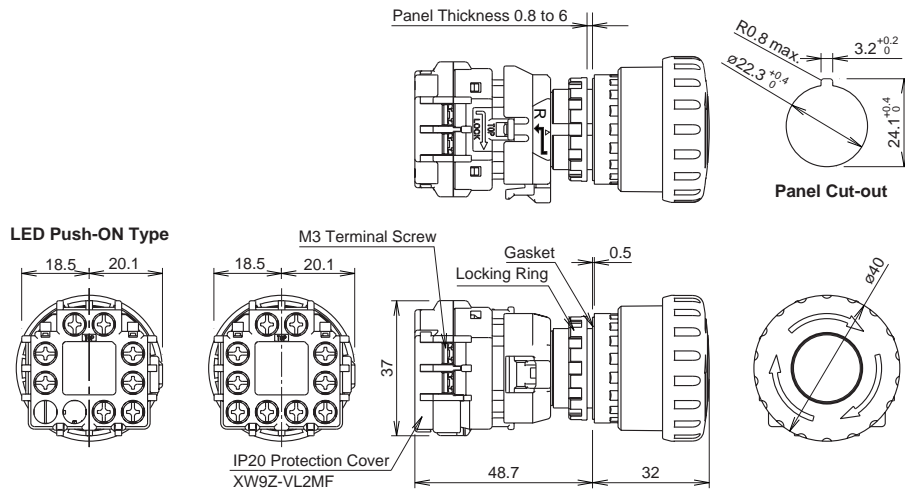

- Screw Terminal (w/terminal cover) LED Illuminated Type
ø40mm Operator

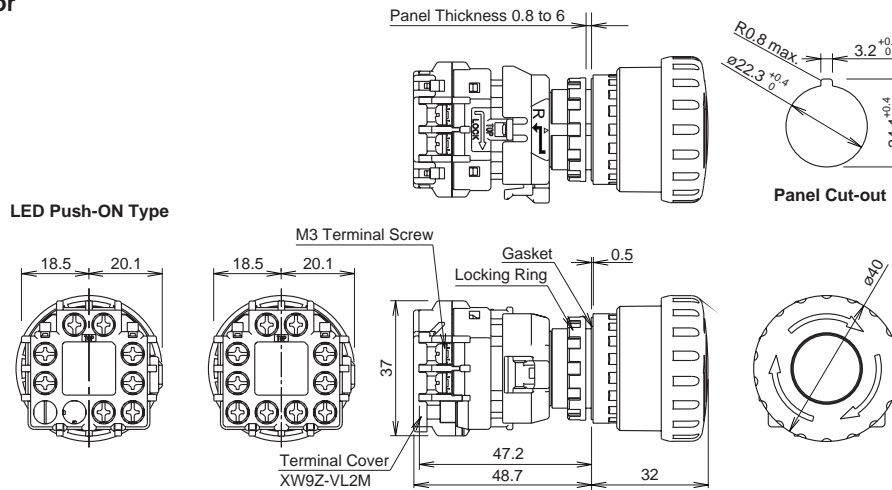

- Solder Terminal and PC Board Terminal LED Illuminated Types
40mm Operator

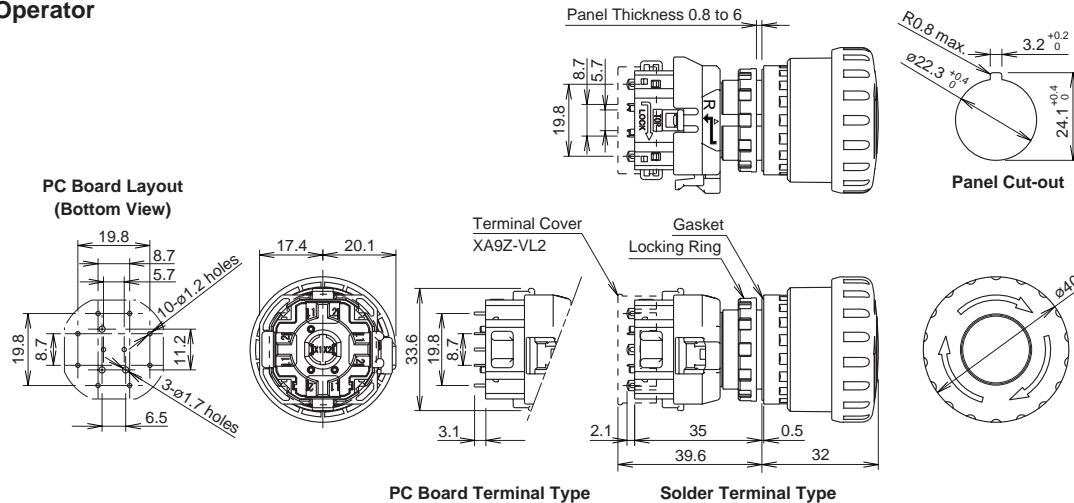

All dimensions in mm.

ø22mm XW series Emergency Stop Switches

Mounting Hole Layout

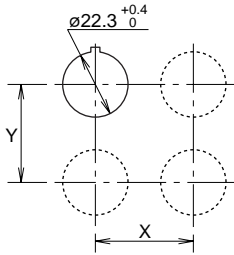

	X	Y
Screw Terminal Type	70 mm minimum	
Solder/PC Board Terminal Type	50 mm minimum	

- The values shown above are the minimum dimensions for mounting with other ø22mm pushbuttons. For other control units of different sizes and styles, determine the values according to the dimensions, operation, and wiring convenience.

All dimensions in mm.

Terminal Arrangement (Bottom View)

• Screw Terminal Non-illuminated Type

NC main contacts only
NC main contacts:
Terminals 1-2

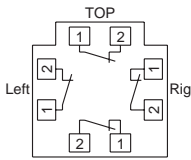

1NC: Terminals on right
2NC: Terminals on right and left
3NC: Terminals on right, left, and top

With 1NO monitor contacts
NC main contacts:
Terminals 1-2
NO monitor contacts:
Terminals 3-4

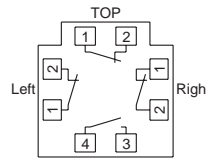

1NC: Terminals on top
2NC: Terminals on right and left

With 2NO monitor contacts
NC main contacts:
Terminals 1-2
NO monitor contacts:
Terminals 3-4

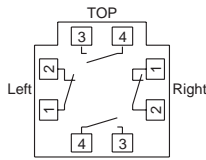

• Non-illuminated Solder Terminal/PC Board Terminal Types

NC main contacts only
NC main contacts:
Terminals 1-2

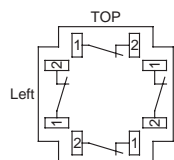

1NC: Terminals on right
2NC: Terminals on right and left
3NC: Terminals on right, left, and top

With 1NO monitor contacts
NC main contacts:
Terminals 1-2
NO monitor contacts:
Terminals 3-4

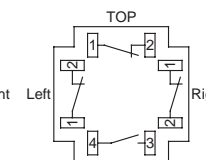

1NC: Terminals on top
2NC: Terminals on right and left

With 2NO monitor contacts
NC main contacts:
Terminals 1-2
NO monitor contacts:
Terminals 3-4

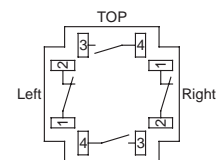

Solder Terminal Type only

• Screw Terminal Illuminated Type

NC main contacts only
NC main contacts:
Terminals 1-2

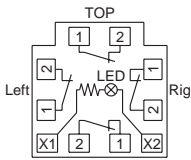

1NC: Terminals on right
2NC: Terminals on right and left
3NC: Terminals on right, left, and top

With 1NO monitor contacts
NC main contacts:
Terminals 1-2
NO monitor contacts:
Terminals 3-4

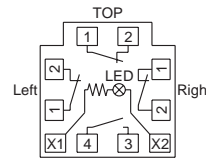

1NC: Terminals on top
2NC: Terminals on right and left

With 2NO monitor contacts
NC main contacts:
Terminals 1-2
NO monitor contacts:
Terminals 3-4

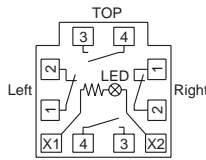

• Solder Terminal/PC Board Terminal Illuminated Types

NC main contacts only
NC main contacts:
Terminals 1-2

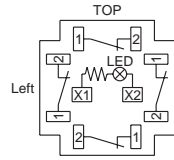

1NC: Terminals on right
2NC: Terminals on right and left
3NC: Terminals on right, left, and top

With 1NO monitor contacts
NC main contacts:
Terminals 1-2
NO monitor contacts:
Terminals 3-4

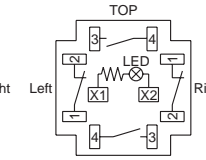

1NC: Terminals on top
2NC: Terminals on right and left

With 2NO monitor contacts
NC main contacts:
Terminals 1-2
NO monitor contacts:
Terminals 3-4

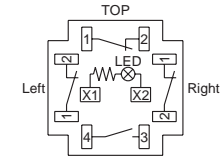

Solder Terminal Type only

• Screw Terminal Illuminated Push-ON Type

NC main contacts only
NC main contacts:
Terminals 1-2

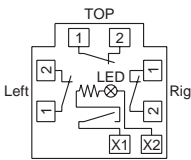

With 1NO monitor contacts
NC main contacts:
Terminals 1-2
NO monitor contacts:
Terminals 3-4

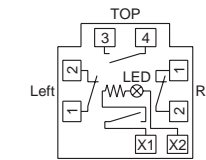





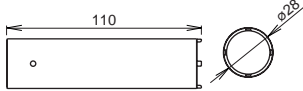

Notes:

- For screw terminal types, the back label of contact block shows the terminal numbers of contacts in two digits. The number in ten digits show the contact number, while the number in the units place show the contact codes (NC main contact: 1-2, NO monitor contact: 3-4).
- For solder terminal and PC board terminal types, the contact block is marked with contact codes (NC main contact 1-2: black, NO monitor contact 3-4: blue).

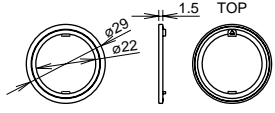
ø22mm XW series Emergency Stop Switches

Accessories

Description & Appearance	Material	Type No.	Ordering Type No.	Package Quantity	Remarks
 <p>Ring Wrench</p>	Metal (nickel-plated brass) (weight: approx. 150 g)	MW9Z-T1	MW9Z-T1	1	<ul style="list-style-type: none"> Used to tighten the locking ring when installing the XW emergency stop switch onto a panel. 
 <p>Anti-rotation Ring</p>	Plastic	HW9Z-RL	HW9Z-RLPN10	10	<ul style="list-style-type: none"> The anti-rotation ring is used for preventing the operator from turning. 
 <p>Locking Ring</p>	Plastic	HW9Z-LN	HW9Z-LNPN05	5	<ul style="list-style-type: none"> Black
 <p>Terminal Cover</p>	PBT	XA9Z-VL2	XA9Z-VL2PN02	2	<ul style="list-style-type: none"> White Used for solder terminals. Also applicable to the XA series.
 <p>Terminal Cover</p>	PPE	XW9Z-VL2M	XW9Z-VL2MPN02	2	<ul style="list-style-type: none"> Black Used for screw terminals.
 <p>IP20 Protection Cover</p>	Polyamide	XW9Z-VL2MF	XW9Z-VL2MFPN02	2	<ul style="list-style-type: none"> Black Used on terminals for IP20 finger protection. Only solid wires can be used. The IP20 protection cover cannot be removed once installed.

Note:

- XW emergency stop switches of screw terminal type are provided with a terminal cover.
- All dimensions in mm.

ø22mm XW series Emergency Stop Switches

Nameplate

Description	Legend	Type No.	Ordering Type No.	Package Quantity	Material	Plate Color	Legend Color
For ø40mm Operator	(blank)	HWAV-0	HWAV-0	1	Polyamide	Yellow	Black
	EMERGENCY STOP	HWAV-27	HWAV-27				
For ø60mm Operator	(blank)	HWAV5-0	HWAV5-0	1	PBT	Yellow	Black
	EMERGENCY STOP	HWAV5-27	HWAV5-27				
	EMERGENCY STOP	HWAV5F-27	HWAV5F-27PN10	10	PET film sticker		

• For ø40mm Operator

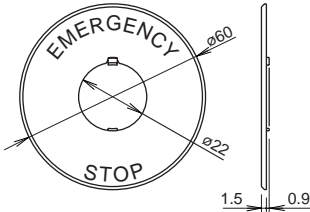

- Panel thickness when using the nameplate: 0.8 to 4.5 mm

• For ø60mm Operator

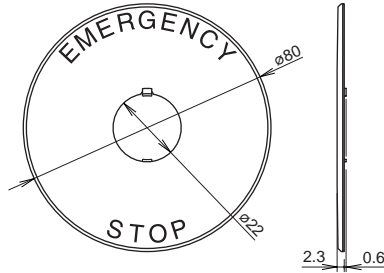

- Panel thickness when using the marking plate: 0.8 to 4 mm

• Sticker-type Nameplate for ø60mm Operator

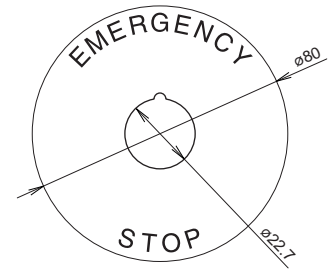

SEMI-compliant Switch Guards (ø22mm panel cut-out)

• SEMI S2-0200, 12.5.1 compliant



- Type No.: HW9Z-KG1
- Degree of Protection: IP65
- Color: Yellow
- Package quantity: 1

• SEMATECH Application Guide for SEMI S2-93, 12.4 compliant



- Type No.: HW9Z-KG2
- Degree of Protection: IP65
- Color: Yellow
- Package quantity: 1

• EMO Sticker



- Type No.: HW9Z-EMO-NPP
- Color: Yellow (red legend)
- Package quantity: 10

Dimensions

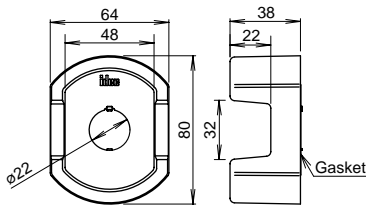

Dimensions

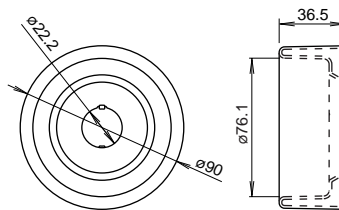

Mounting

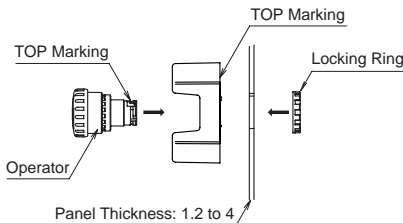

Mounting

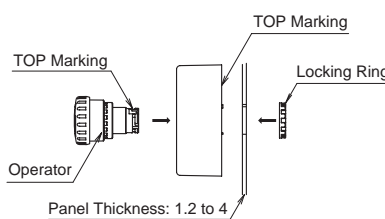

All dimensions in mm.

- The HW9Z-KG1 and HW9Z-KG2 switch guards are applicable for ø40mm operators only.

Caution:

International industrial standards such as European Union Directive, IEC60204-1, and JIS B9960-1 require that emergency stop switches must be installed in the manner in which the operator can access and operate the switches easily, and prohibit the use of switch guards. The HW9Z-KG1 and HW9Z-KG2 switch guards are used for the emergency stop switches installed on semiconductor manufacturing equipment only. Do not use the switch guards for emergency stop switches installed on machine systems such as machine tool and food processing systems.

ø22mm XW series Emergency Stop Switches

Operating Instructions

Removing the Contact Block

First unlock the operator button. Grab the bayonet ring ① and pull back the bayonet ring until the latch pin clicks ②, then turn the contact block counterclockwise and pull out ③.

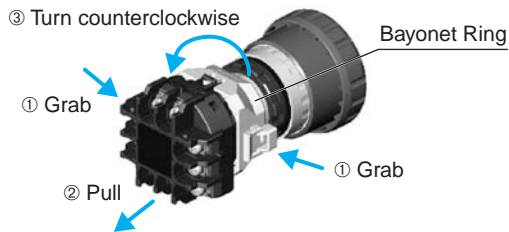

• Notes for removing the contact block

1. When the contact block is removed, the monitor contact (NO contact) is closed.
2. While removing the contact block, do not exert excessive force, otherwise the switch may be damaged.
3. An LED lamp is built into the contact block for illuminated pushbuttons. When removing the contact block, pull the contact block straight to prevent damage to the LED lamp. If excessive force is exerted, the LED lamp may be damaged and fail to light.

Panel Mounting

Remove the locking ring from the operator and check that the rubber gasket is in place. Insert the operator from panel front into the panel hole. Face the side without thread on the operator with TOP marking upward, and tighten the locking ring using ring wrench MW9Z-T1 to a torque of 2.0 N·m maximum.

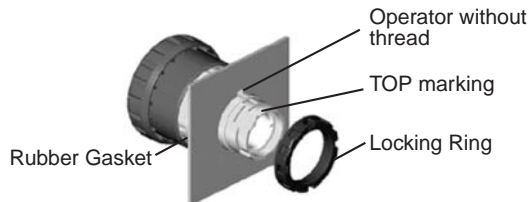

• Notes for Panel Mounting

To prevent the XW emergency stop switch from rotating when resetting from the latched position, use of an anti-rotation ring (HW9Z-RL) or a nameplate is recommended.

Installing the Contact Block

First unlock the operator button. Align the small ▼ marking on the edge of the operator with the small ▲ marking on the yellow bayonet ring. Hold the contact block, not the bayonet ring. Press the contact block onto the operator and turn the contact block clockwise until the bayonet ring clicks.

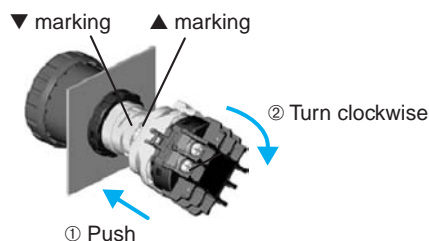

Notes for installing the contact block

Make sure that the bayonet ring is in the locked position. Check that the two projections on the bayonet ring are securely in place.

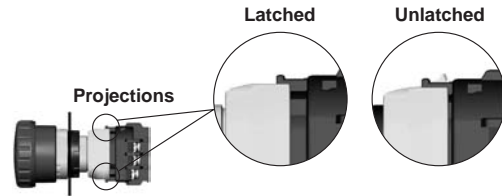

Wiring

1. The applicable wire size is 1.25 mm² maximum.
2. Solder the terminals using a 20W soldering iron within 5 seconds, or at 260°C within 3 seconds. Do not apply external force. Make sure that the soldering iron touches the terminals only. When wiring, do not apply tensile force on the terminals.
3. Use a non-corrosive rosin flux.
4. Because the terminal spacing is narrow, use protective tubes or heat shrinkable tubes to avoid burning of wire coating or short circuit.

• PC Board Terminal Type

1. When mounting a contact block on a PC board, provide sufficient rotating space for the PC board when installing and removing the contact block.
2. When mounting an XW emergency stop switch on a PC board, make sure that the operator is securely installed.

• About PC Board and Circuit Design

1. Use PC boards made of glass epoxy copper-clad laminated sheets of 1.6 mm in thickness, with double-sided through hole.
2. PC boards and circuits must withstand rated voltage and current, including the instantaneous current and voltage at switching.
3. The minimum applicable load is 5V AC/DC, 1 mA. This value may vary according to the operating environment and load.
4. Within the 2.8* mm areas shown in the figure below, terminals touch the PC board, resulting in possible short circuit on the printed circuit. When designing a PC board pattern, take this possibility into consideration.

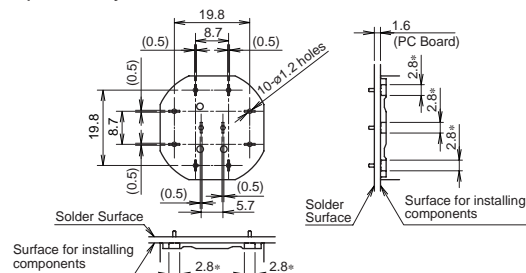

• Screw Terminal Type

1. Wire thickness: 0.75 to 1.25 mm² (AWG18 to 16)

Applicable Crimping Terminal

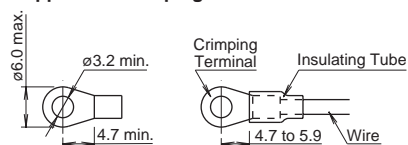

Solid Wire



- Be sure to install an insulating tube on the crimping terminal.
2. Tighten the M3 terminal screw to a tightening torque of 0.6 to 1.0 N·m.

All dimensions in mm.

ø22mm XW series Emergency Stop Switches

Operating Instructions

Installing & Removing Terminal Covers

• XA9Z-VL2

To install the terminal cover, align the TOP marking on the terminal cover with TOP marking on the contact block, and press the terminal cover toward the contact block.



Note: For wiring, insert the wires into the holes in the terminal cover before soldering.

• XA9Z-VL2M

To install the terminal cover, align the TOP marking on the terminal cover with the TOP marking on the contact block. Place the two projections on the bottom side of the contact block into the slots in the terminal cover. Press the terminal cover toward the contact block.

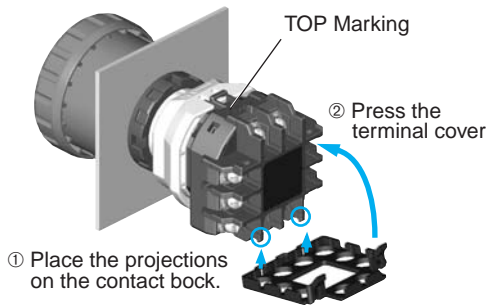

To remove the terminal cover, pull out the two latches on the top side of the terminal cover. Do not exert excessive force to the latches, otherwise the latches may break.

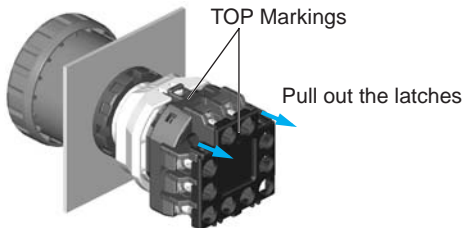

IP20 Protection Terminal Cover XW9Z-VL2MF

To install the IP20 protection cover, align the TOP marking on the cover with the TOP marking on the contact block, and press the cover toward the contact block.

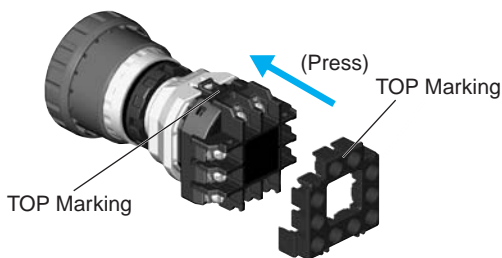

Notes:

1. Once installed, the XW9Z-VL2MF cannot be removed.
2. The XW9Z-VL2MF cannot be installed after wiring.
3. With the XW9Z-VL2MF installed, crimping terminals cannot be used. Use solid wires.
4. Make sure that the XW9Z-VL2MF is securely installed. IP20 cannot be achieved when installed loosely, and electric shocks may occur.

Contact Bounce

When the button is reset by pulling or turning, the NC main contacts will bounce. When pressing the button, the NO monitor contacts will bounce.

When designing a control circuit, take the contact bounce time into consideration (reference value: 20 ms).

LED Illuminated Switches

An LED lamp is built into the contact block and cannot be replaced.

Installing the Anti-rotation Ring HW9Z-RL

Align the side without thread on the operator with TOP marking, the small ▲ marking on the anti-rotation ring, and the recess on the mounting panel.

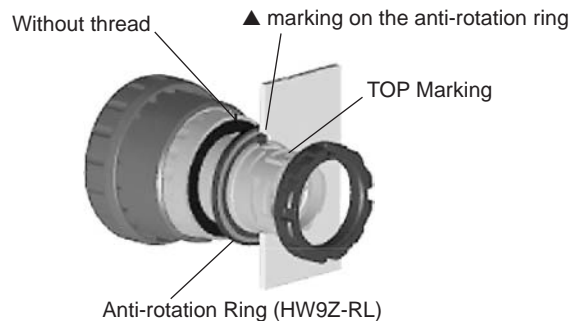

Installing the Nameplate

Align the side without thread on the operator with TOP marking, the projection on the nameplate, and the recess on the mounting panel.

Nameplate or Switch Guard

When anti-rotation is not required, remove the projection from the nameplate or switch guard using pliers.

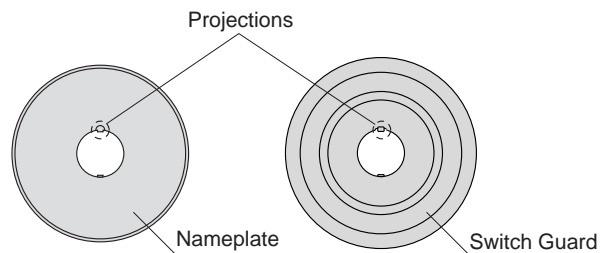

Handling

Do not expose the switch to excessive shocks and vibrations, otherwise the switch may be deformed or damaged, causing malfunction or operation failure.

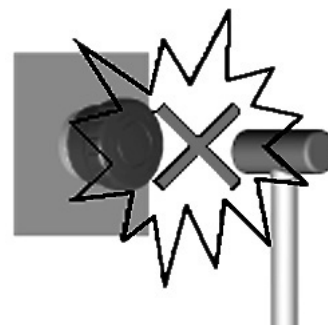



Safety Precautions

- Read the user's manual to ensure correct operation before starting installation, wiring, operation, maintenance, and inspection of the XA and XW emergency stop switches.

Specifications and other descriptions in this catalog are subject to change without notice.



IDEC IZUMI CORPORATION

7-31, Nishi-Miyahara 1-Chome, Yodogawa-ku, Osaka 532-8550, Japan
Tel: +81-6-6398-2571, Fax: +81-6-6392-9731
www.idec.com

IDEC CORPORATION (USA)

1175 Elko Drive, Sunnyvale, CA 94089-2209, USA
Tel: +1-408-747-0550, Toll Free: (800) 262-IDECC, Fax: +1-408-744-9055
E-mail: opencontact@idec.com, www.idec.com

IDEC CANADA LIMITED

Unit 22-151, Brunel Road Mississauga, Ontario, L4Z 1X3, Canada
Tel: +1-905-890-8561, Toll Free: (888) 317-4332, Fax: +1-905-890-8562

IDEC ELECTRONICS LIMITED

Unit 2, Beechwood, Chineham Business Park, Basingstoke, Hampshire
RG24 8WA, UK
Tel: +44-1256-321000, Fax: +44-1256-327755

E-mail: idec@uk.idec.com

IDEC ELEKTROTECHNIK GmbH

Wendenstraße 331, D-20537 Hamburg, Germany
Tel: +49-40-25 30 54-0, Fax: +49-40-25 30 54-24
E-mail: service@idec.de, www.idec.de

IDEC AUSTRALIA PTY. LTD.

2/3 Macro Court, Rowville, Victoria 3178, Australia
Toll Free: 1-800-68-4332, Fax: +61-3-9763-3255
E-mail: sales@au.idec.com

IDEC IZUMI ASIA PTE. LTD.

No. 31, Tannery Lane #05-01, Dragon Land Building, Singapore 347788
Tel: +65-6746-1155, Fax: +65-6844-5995
E-mail: generalinfo@idecasia.com.sg

IDEC IZUMI (H.K.) CO., LTD.

Room 1409, Tower 1, Silvercord, 30 Canton Road, Tsimshatsui, Kowloon,
Hong Kong

Tel: +852-2-376-2823, Fax: +852-2-376-0790

E-mail: idec@idechk.com

IDEC IZUMI (Shanghai) Co., Ltd.

Room E, 15F, Majesty Building, No. 138 Pudong Avenue,
Shanghai 200120, P.R.C.

Tel: +86-21-5887-9181, Fax: +86-21-5887-8930

E-mail: idec@cn.idec.com

IDEC TAIWAN CORPORATION

8F, No. 79, Hsin Tai Wu Road, Sec. 1, Hsi-Chih, Taipei County, Taiwan

Tel: +886-2-2698-3929, Fax: +886-2-2698-3931

E-mail: service@idectwn.com.tw