



### Features

- Wide input range 100~305VAC(class I )
- Full power output at 75~100% constant power mode operation
- Metal case with IP67,suitable for outdoor application
- Surge protection with 6KV/4KV
- 3 in 1 dimming (Dim-to-off and Isolation design)
- Protection Functions : OLP / SCP / OVP / OTP
- Typical lifetime>50,000 hours and 5 years warranty

### Applications

- Bay lighting
- Stage lighting
- Floodlight lighting
- Fishing lighting
- Horticulture lighting
- Stadium lighting
- DMX power supply
- Type "HL" for use in class I , Division 2

### GTIN CODE

MW Search: <https://www.meanwell.com/serviceGTIN.aspx>

### Description

XLG-320 series is a 315W LED AC/DC driver featuring the constant power mode and high voltage output. XLG-320 operates from 100~305VAC and offers models with different rated current ranging between 1050mA and 18000mA. Thanks to the high efficiency up to 94.5%, with the fanless design, the entire series is able to operate for -40°C~+85°C case temperature under free air convection. The design of metal housing and IP67 ingress protection level allows this series to fit both indoor and outdoor applications. Moreover the innovative environment-adaptive capability allows this series to reliably light on the LEDs for all kinds of application environments in almost any spots that may install LED luminaires in the world. XLG-320 series comply with the latest version of IEC61347/GB7000.1-2015 and UL8750 international safety regulations. The output and dimming circuit are also completely in accordance with the new regulations and isolation to ensure the safety of both user and luminaire system during installation.

### Model Encoding

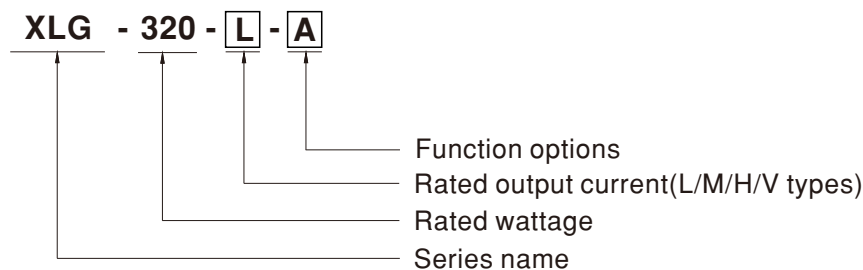

| Type  | IP Level | Function  | Note       |
|-------|----------|---|------------|
| Blank | IP67     | Io and Vo fixed.(For harsh environment)   | By request |
| A     | IP67     | Output constant power adjustable via built-in Io potentiometer  | In Stock   |
| AB    | IP67     | Output constant power adjustable via built-in Io potentiometer + 3 in 1 dimming function (0~10Vdc, 10V PWM signal and resistance) | In Stock   |

Note: V model is constant voltage operation without the AB type

**SPECIFICATION**

| MODEL                         | XLG-320-L-□  | XLG-320-M-□  | XLG-320-H-□   | XLG-320-V-□                             |                         |
|-------------------------------|--|--|---|---|-------------------------|
| OUTPUT                        | DEFAULT CURRENT  | 1400mA   | 2800mA  | 5600mA                                  | 13A/24V                 |
|                               | RATED POWER <small>Note.10</small>   | 315W   | 310.8W  | 312W                                    | 24V/312W, 12V/216W      |
|                               | CONSTANT CURRENT REGION  | 150~300V   | 74 ~ 148V   | 30 ~ 56V                                | NC                      |
|                               | OUTPUT VOLTAGE ADJ. RANGE  | NC   | NC  | NC                                      | 24V or 12V              |
|                               | FULL POWER CURRENT RANGE   | 1050~1400mA  | 2100~2800mA   | 5570~7420mA                             | 13~18A(24V/13A,12V/18A) |
|                               | OPEN CIRCUIT VOLTAGE (max.)  | 340V   | 180V  | 60V                                     | NC                      |
|                               | CURRENT ADJ. RANGE   | 500~1400mA   | 1050~2800mA   | 2800~7420mA                             | NC                      |
|                               | CURRENT RIPPLE   | 5.0% max. @rated current   | 5.0 max. @rated current   | 5.0% max. @rated current                | NC                      |
|                               | CURRENT TOLERANCE  | ±5%  | ±5%   | ±5%                                     | NC                      |
|                               | RIPPLE & NOISE(max.)   | NC   | NC  | NC                                      | 240mV p-p               |
|                               | VOLTAGE TOLERANCE  | NC   | NC  | NC                                      | ±3%                     |
|                               | LINE REGULATION  | NC   | NC  | NC                                      | ±0.5%                   |
|                               | LOAD REGULATION  | NC   | NC  | NC                                      | ±2%                     |
|                               | SET UP TIME <small>Note.9</small>  | 500ms/230VAC, 1200ms/115VAC  |   |   |                         |
| RISE TIME,HOLD UP TIME (Typ.) | 160ms,10ms/230VAC/115VAC(only for V-type)  |  |   |   |                         |
| INPUT                         | VOLTAGE RANGE <small>Note.2</small>  | 100 ~ 305VAC 142VDC ~ 431VDC<br>(Please refer to "STATIC CHARACTERISTIC" and "DRIVING METHODS OF LED MODULE" section)  |   |   |                         |
|                               | FREQUENCY RANGE  | 47 ~ 63Hz  |   |   |                         |
|                               | POWER FACTOR (Typ.)  | PF ≥ 0.98 / 115VAC, PF ≥ 0.95 / 230VAC, PF ≥ 0.92 / 277VAC at full load<br>(Please refer to "Power Factor Characteristic" section)                                 |   |   |                         |
|                               | TOTAL HARMONIC DISTORTION  | THD < 10% @ load ≥ 50% at 115VAC/230VAC, THD < 15% @ Load > 75% at 277VAC;<br>Please refer to "TOTAL HARMONIC DISTORTION (THD)" section                            |   |   |                         |
|                               | EFFICIENCY (Typ.)  | 94.5%  | 93.5%   | 92.5%                                   | 93%                     |
|                               | AC CURRENT (Typ.)  | 3A / 120VAC  | 1.6A / 230VAC   | 1.3A / 277VAC                           |                         |
|                               | INRUSH CURRENT(Typ.)   | COLD START 45A(twidth=1200μs measured at 50% Ipeak) at 230VAC; Per NEMA 410  |   |   |                         |
|                               | MAX. NO. of PSUs on 16A CIRCUIT BREAKER  | 2 unit(circuit breaker of type B) / 4 units(circuit breaker of type C) at 230VAC   |   |   |                         |
|                               | LEAKAGE CURRENT  | <0.75mA / 277VAC   |   |   |                         |
|                               | STANDBY POWER CONSUMPTION <small>Note.5</small>  | Standby power consumption <0.5W for AB-Type(Dimming OFF)   |   |   |                         |
| PROTECTION                    | SHORT CIRCUIT  | Hiccup mode or Constant current limiting, recovers automatically after fault condition is removed  |   |   |                         |
|                               | OVER VOLTAGE   | 350 ~ 380V   | 190 ~ 220V  | 63 ~ 78V                                | 27 ~ 34V                |
|                               | OVER TEMPERATURE <small>Note.11</small>  | L/M/H-Type: Tcase>85°C ±5°C, derate power automatically<br>V-Type: Shut down output voltage, re-power on to recover  |   |   |                         |
|                               | OVER LOAD <small>Note.10</small>   | 108~135%(only for V-type)<br>Hiccup mode or Constant current limiting, recovers automatically after fault condition is removed                                     |   |   |                         |
|                               | ENVIRONMENT  | WORKING TEMP.  | Tcase=-40 ~ +85°C(Please refer to "OUTPUT LOAD vs TEMPERATURE" section) |   |                         |
| MAX. CASE TEMP.               |  | Tcase=+85°C  |   |   |                         |
| WORKING HUMIDITY              |  | 20 ~ 95% RH non-condensing   |   |   |                         |
| STORAGE TEMP., HUMIDITY       |  | -40 ~ +80°C, 10 ~ 95% RH non-condensing  |   |   |                         |
| TEMP. COEFFICIENT             |  | ±0.03%/°C (0 ~ 60°C)   |   |   |                         |
| VIBRATION                     |  | 10 ~ 500Hz, 5G 12min./1cycle, period for 72min. each along X, Y, Z axes  |   |   |                         |
| SAFETY & EMC                  | SAFETY STANDARDS   | UL8750(type"HL"), CSA C22.2 No. 250.13-12; ENEC BS EN/EN61347-1, BS EN/EN61347-2-13 independent, BS EN/EN62384; GB19510.1, GB19510.14;EAC TP TC 004; IP67 approved |   |   |                         |
|                               | WITHSTAND VOLTAGE  | I/P-O/P:3.75KVAC I/P-FG:2KVAC O/P-FG:1.5KVAC   |   |   |                         |
|                               | ISOLATION RESISTANCE   | I/P-O/P, I/P-FG, O/P-FG:100M Ohms / 500VDC / 25°C / 70% RH   |   |   |                         |
|                               | EMC EMISSION   | Parameter  | Standard  | Test Level / Note                       |                         |
|                               |  | Conducted  | BS EN/EN55015(CISPR15), GB/T17743                                       | -----                                   |                         |
|                               |  | Radiated   | BS EN/EN55015(CISPR15), GB/T17743                                       | -----                                   |                         |
|                               |  | Harmonic Current   | BS EN/EN61000-3-2, GB/T17625.1  | Class C @load≥50%                       |                         |
|                               | EMC IMMUNITY   | Voltage Flicker  | BS EN/EN61000-3-3   | -----                                   |                         |
|                               |  | Parameter  | Standard  | Test Level / Note                       |                         |
|                               |  | ESD  | BS EN/EN61000-4-2   | Level 3, 8KV air ; Level 2, 4KV contact |                         |
| Radiated                      |  | BS EN/EN61000-4-3  | Level 2   |   |                         |
| EFT / Burst                   |  | BS EN/EN61000-4-4  | Level 3   |   |                         |
| Surge                         |  | BS EN/EN61000-4-5  | 4KV/Line-Line 6KV/Line-Earth  |   |                         |
| Conducted                     |  | BS EN/EN61000-4-6  | Level 2   |   |                         |
| Magnetic Field                |  | BS EN/EN61000-4-8  | Level 4   |   |                         |
| OTHERS                        | MTBF   | 1476.4K hrs min. Telcordia SR-332(Bellcore) ; 168.1 K hrs min. MIL-HDBK-217F (25°C)  |   |   |                         |
|                               | DIMENSION  | 246*77*39.5mm (L*W*H)  |   |   |                         |
|                               | PACKING  | 1.45Kg;9pcs/14Kg/0.76CUFT  |   |   |                         |
| NOTE                          | <ol style="list-style-type: none"> <li>All parameters NOT specially mentioned are measured at 230VAC input, rated current and 25°C of ambient temperature.</li> <li>De-rating may be needed under low input voltages. Please refer to "STATIC CHARACTERISTIC" sections for details.</li> <li>The driver is considered as a component that will be operated in combination with final equipment. Since EMC performance will be affected by the complete installation, the final equipment manufacturers must re-qualify EMC Directive on the complete installation again.</li> <li>This series meets the typical life expectancy &gt;50,000 hours of operation when Tcase, particularly (⊙) point (or TMP, per DLC), is 70°C or less.</li> <li>To fulfill requirements of the latest ERP regulation for lighting fixture, this LED driver can only be used behind a switch without permanently connected to the mains.</li> <li>Please refer to the warranty statement on MEAN WELL's website at <a href="http://www.meanwell.com">http://www.meanwell.com</a></li> <li>The ambient temperature derating of 3.5°C/1000m with fanless models and of 5°C/1000m with fan models for operating altitude higher than 2000m(6500ft).</li> <li>For any application note and IP water proof function installation caution, please refer our user manual before using. <a href="https://www.meanwell.com/Upload/PDF/LED_EN.pdf">https://www.meanwell.com/Upload/PDF/LED_EN.pdf</a></li> <li>Products sourced from the Americas regions may not have the ENEC/CCC/KC logo. Please contact your MEAN WELL sales for more information.</li> <li>The output voltage of the V Type can be adjusted by the SVR, with the default voltage is 24V, and 12V output should twist clockwise to the end. Please twist VR to the end, otherwise the OLP will be beyond specification.</li> <li>When the secondary OTP fails, there is also a primary OTP, which is protected by Shut down output voltage, re-power on to recovery for the H/M/L-type.</li> <li>When the current adjustment is more than 110% of the rated current, it will be enter the Protection state.</li> <li>It may has an over-shoot status at output current when AC On/Off operate with lower Vf and lower loading conditions.</li> <li>If you need the NOM (Mexico) certificate, Please contact MEAN WELL sales representative for details.</li> <li>Ripple &amp; noise are measured at 20MHz of bandwidth by using a 12" twisted pair-wire terminated with a 0.1uf &amp; 47uf parallel capacitor.</li> <li>Please refer to "DRIVING METHODS OF LED MODULE".</li> </ol> <p>※ Product Liability Disclaimer : For detailed information, please refer to <a href="https://www.meanwell.com/serviceDisclaimer.aspx">https://www.meanwell.com/serviceDisclaimer.aspx</a></p> |  |   |   |                         |

## ■ BLOCK DIAGRAM

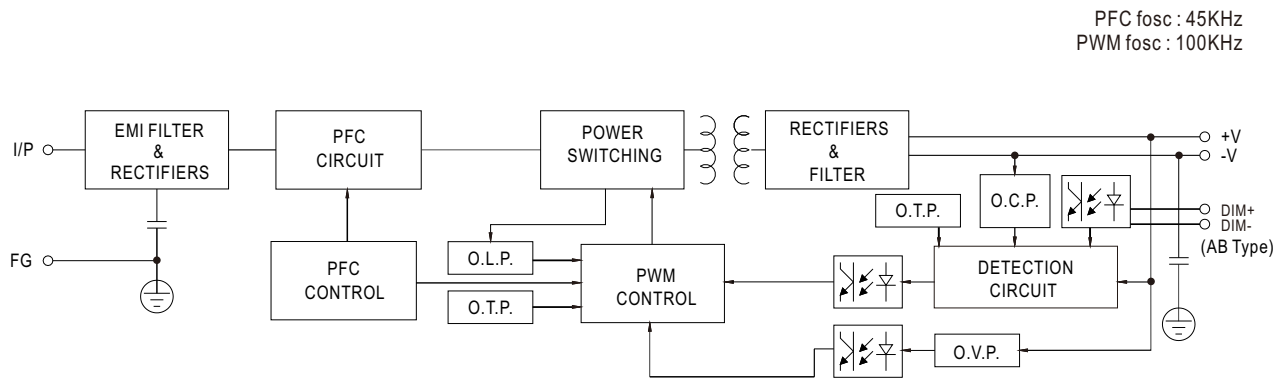

## ■ DRIVING METHODS OF LED MODULE

◎ XLG-320-L

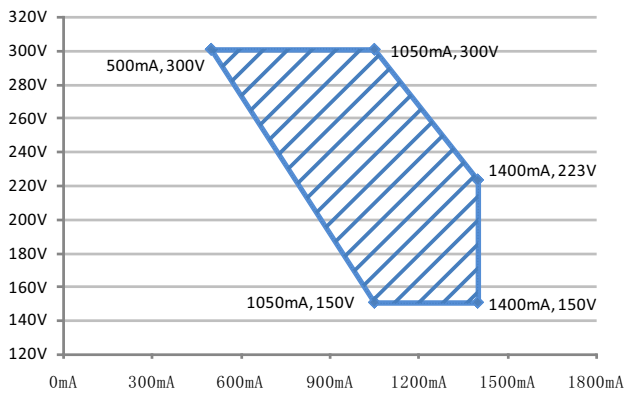

◎ XLG-320-M

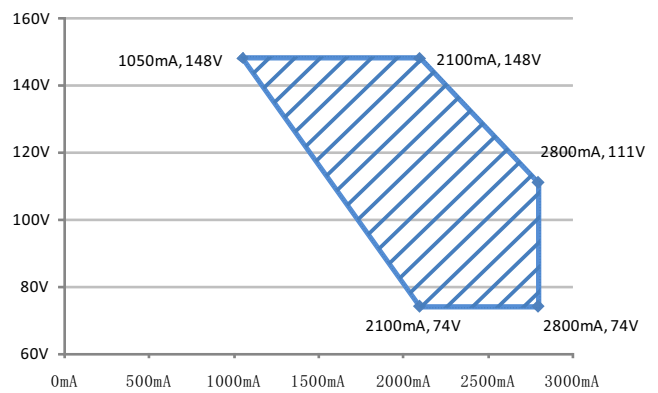

◎ XLG-320-H

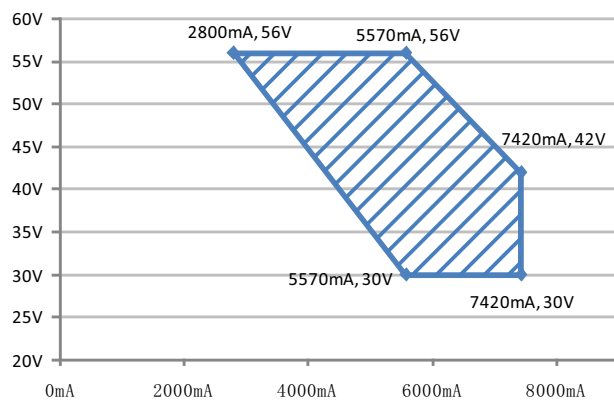

◎ XLG-320-V

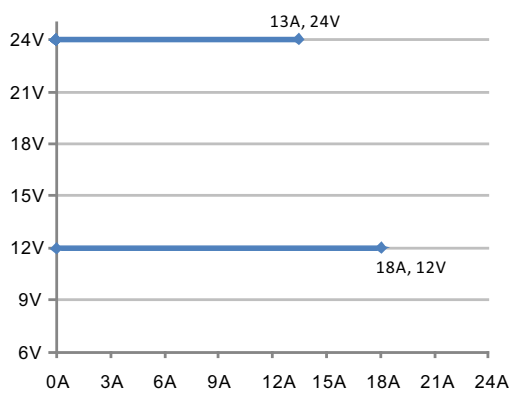

※ V type output voltage adjustable via built-in potentiometer

## DIMMING OPERATION

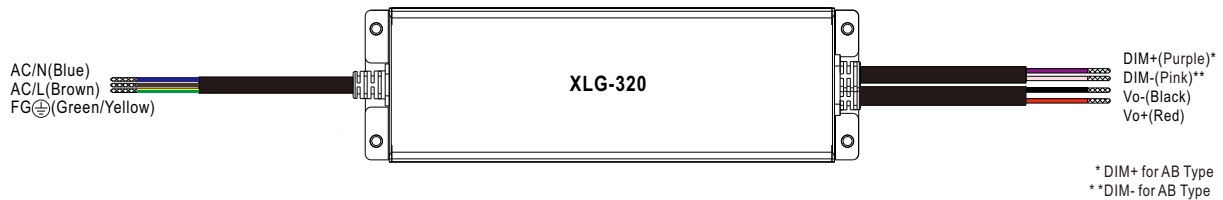

### ※ 3 in 1 dimming function (for AB-Type)

- Output constant current level can be adjusted by applying one of the three methodologies between DIM+ and DIM-: 0 ~ 10VDC, or 10V PWM signal or resistance.
- Direct connecting to LEDs is suggested. It is not suitable to be used with additional drivers.
- Dimming source current from power supply: 100  $\mu$ A (typ.)

#### ◎ Applying additive 0 ~ 10VDC

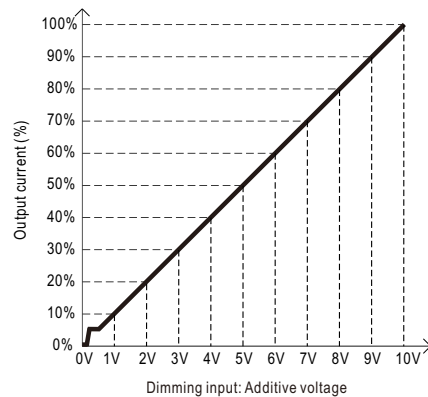
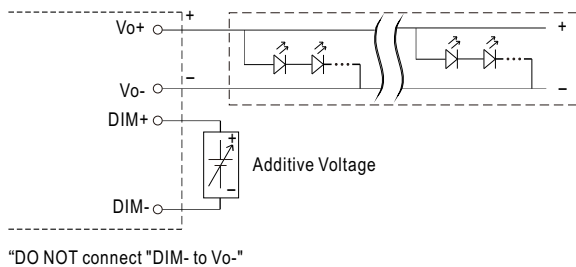

#### ◎ Applying additive 10V PWM signal (frequency range 100Hz ~ 3KHz):

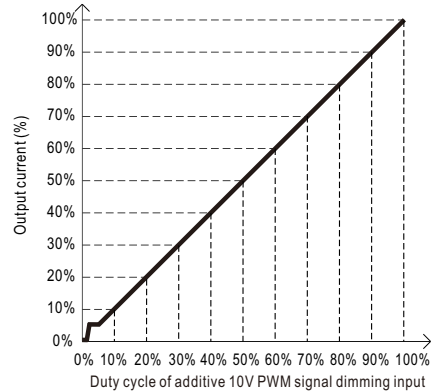
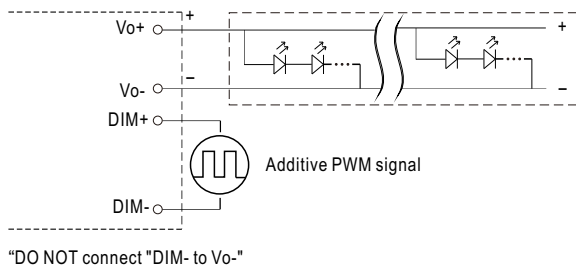

#### ◎ Applying additive resistance:

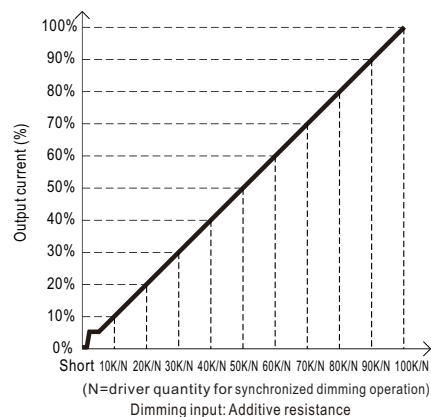
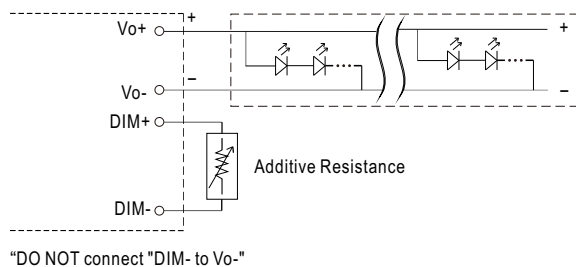

- Note :
1. Min. dimming level is about 8% and the output current is not defined when 0% < lout < 8%.
  2. The output current could drop down to 0% when dimming input is about 0Ω or 0Vdc, or 10V PWM signal with 0% duty cycle.
  3. When PWM frequency > 2KHZ, the lighting will be triggered at 10~15% PWM duty.

**OUTPUT LOAD vs TEMPERATURE**

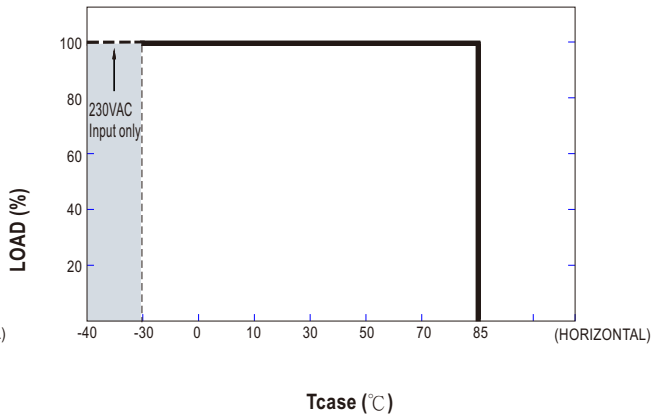
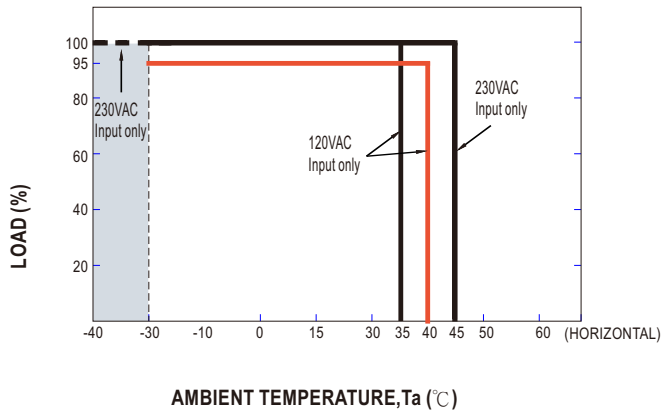

**STATIC CHARACTERISTIC**

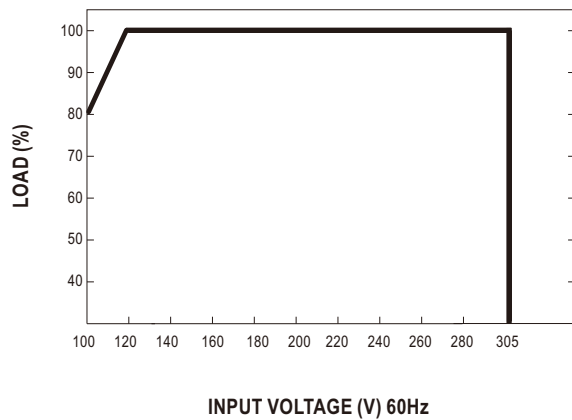

**POWER FACTOR (PF) CHARACTERISTIC**

※ Tcase at 75°C

**Constant Current Mode**

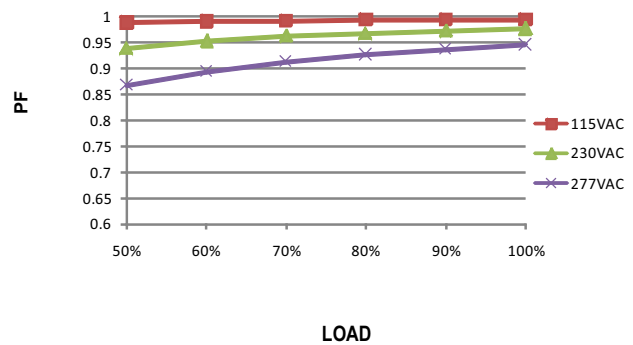

**TOTAL HARMONIC DISTORTION (THD)**

※ XLG-320-L Model, Tcase at 75°C

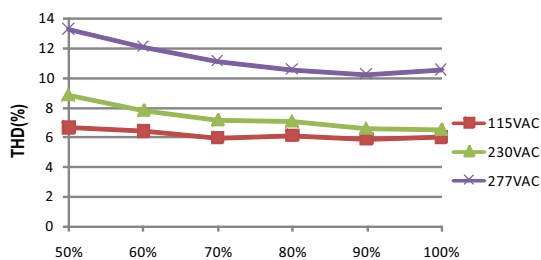

**EFFICIENCY vs LOAD**

XLG-320 series possess superior working efficiency that up to 94.5% can be reached in field applications.

※ XLG-320-L Model, Tcase at 75°C

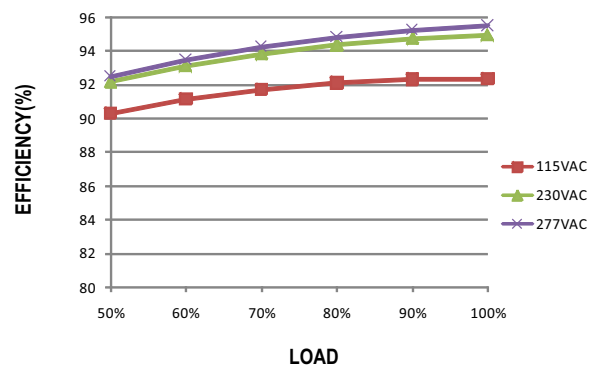



■ LIFE TIME

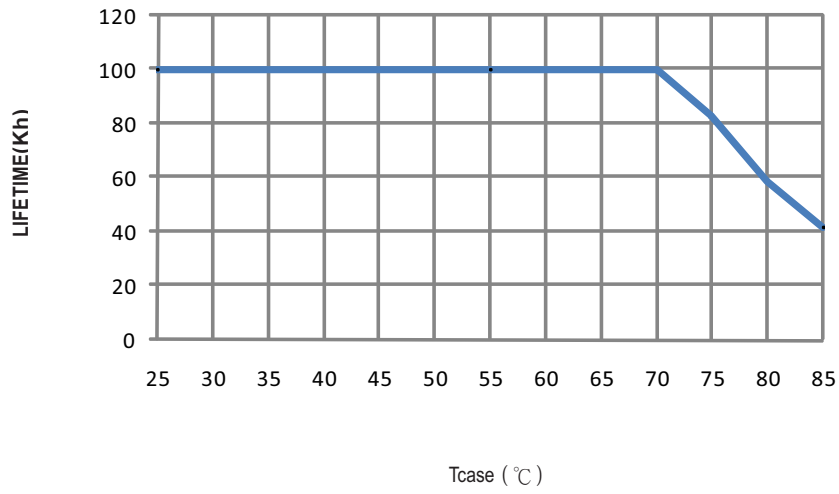

MECHANICAL SPECIFICATION

Case No.:266A Unit:mm

※ V-A-Type

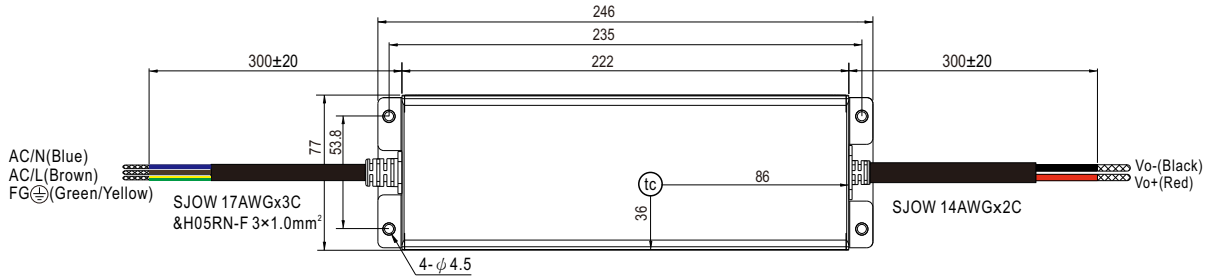

• (tc) : Max. Case Temperature

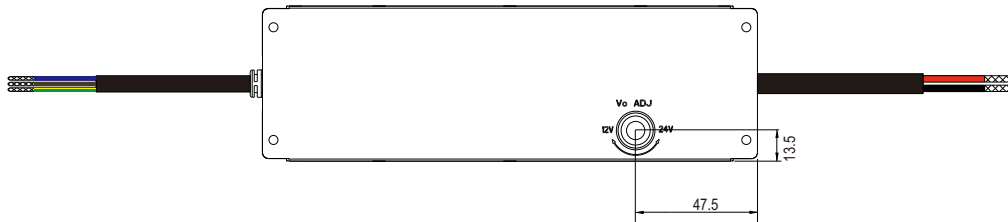
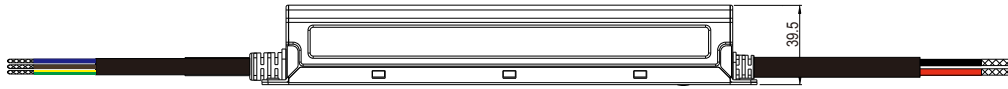

※ H/L/M-A-Type

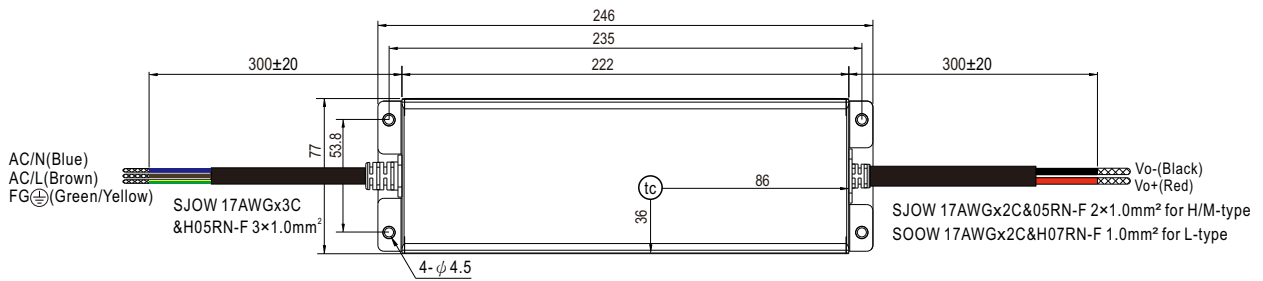

• (tc) : Max. Case Temperature

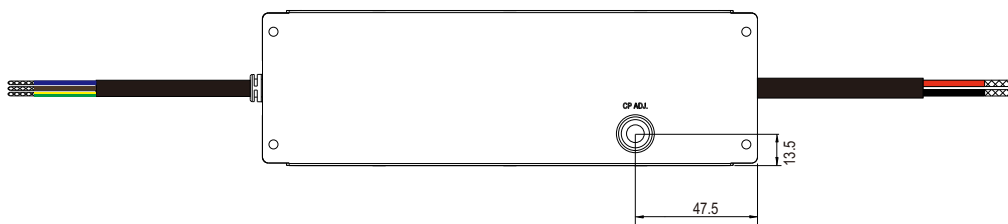
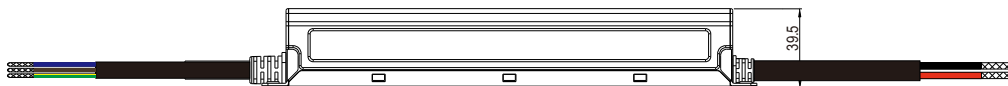

**MECHANICAL SPECIFICATION**

Case No.:266A Unit:mm

※ AB-Type

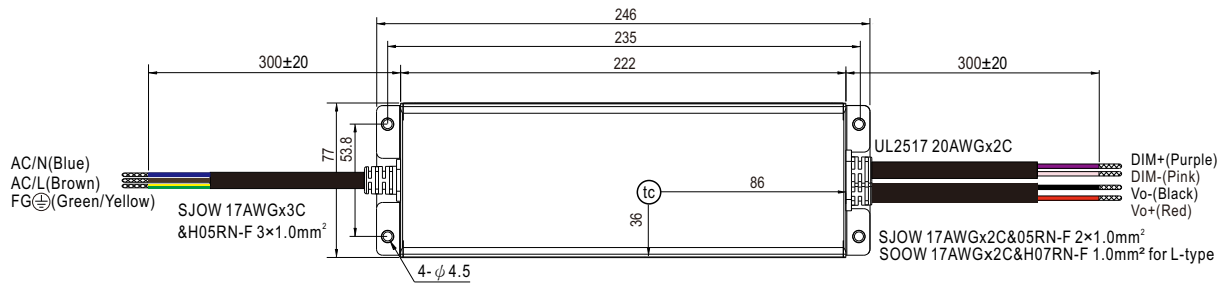

• (tc) : Max. Case Temperature

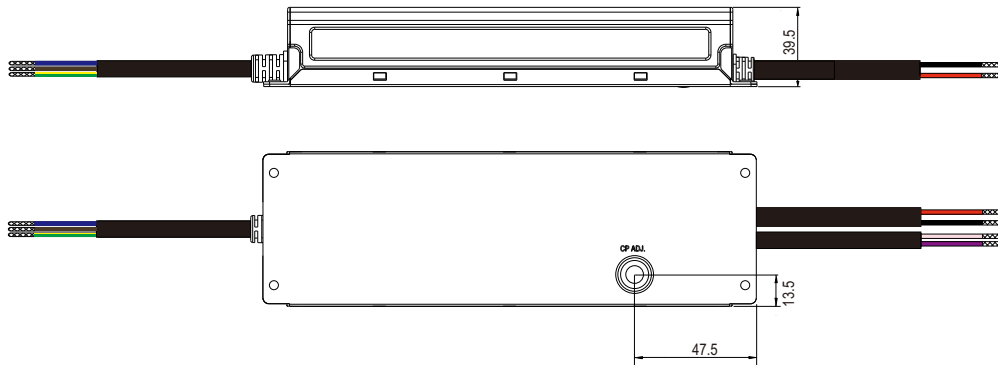

**INSTALLATION MANUAL**

Please refer to : <http://www.meanwell.com/manual.html>