

XC

- Characteristics
- wide range of forces and variants
 - long mechanical and electrical life
 - solder, PCB and faston terminals
 - compliant to glow wire test IEC 60335-1, 4. ed.

Rating 250 VAC, 10 A max.

Dimensions (mm) 19,9 × 9,5 × 6,4

- Actuator
- Plunger
 - mushroom plunger
 - plain levers
 - simulated roller lever/cam follower
 - roller levers

Approvals ENEC, UL, cUL, CSA

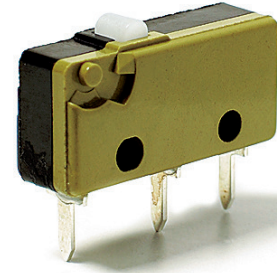

Preferred Range

Ordering Reference	Actuating Force		Operating pos.		Terminal	Circuit	Actuator	Contacts	Electrical rating	
	(N)	(ozf)	(mm)	(in)					ENEC	UL/CSA
XCG3Z1	1,7	6,07	8,4	0,33	Solder	CO	Plunger	Ag	6(2) A	5 A
XCG3-J1Z1	0,6	2,14	10,2	0,40	Solder	CO	Plain lever	Ag	6(2) A	5 A
XCG3-S1Z1	0,7	2,49	15,6	0,61	Solder	CO	Roller lever	Ag	6(2) A	5 A
XCG5Z1	1,7	6,07	8,4	0,33	Faston 2,8 × 0,5 mm	CO	Plunger	Ag	6(2) A	5 A
XCG5-J1Z1	0,6	2,14	10,2	0,40	Faston 2,8 × 0,5 mm	CO	Plain lever	Ag	6(2) A	5 A
XCG5-S1Z1	0,7	2,49	15,6	0,61	Faston 2,8 × 0,5 mm	CO	Roller lever	Ag	6(2) A	5 A
XCG8-81Z1	1,7	6,07	8,4	0,33	PCB	CO	Plunger	Au	none	0,1 A/125 VAC
XCG8-81-J1Z1	0,6	2,14	10,2	0,40	PCB	CO	Plain lever	Au	none	0,1 A/125 VAC
XCG8-81-S1Z1	0,7	2,49	15,6	0,61	PCB	CO	Roller lever	Au	none	0,1 A/125 VAC
XCF3Z1	3,0	10,70	8,4	0,33	Solder	CO	Plunger	Ag	10(3) A	10,1 A
XCF3-J1Z1	1,05	3,74	10,2	0,40	Solder	CO	Plain lever	Ag	10(3) A	10,1 A
XCF3-S1Z1	1,1	3,92	15,6	0,61	Solder	CO	Roller lever	Ag	10(3) A	10,1 A
XCG3-U1Z1	1,7	6,07	9,9	0,39	Solder	CO	Mushroom plunger	Ag	6(2) A	5 A
XCG4-U1Z1	1,7	6,07	9,9	0,39	Faston 2,8 × 0,5 mm	CO	Mushroom plunger	Ag	6(2) A	5 A
XCG8-U1Z1	1,7	6,07	9,9	0,39	PCB	CO	Mushroom plunger	Ag	6(2) A	5 A

Specifications

Housing	Melamine-Formaldehyd, Thermosetting
Plunger	POM for T85, PPS for T125 and T150
Mechanism	Snap-action system with stainless steel tension spring
Functions	Change-over, NO, NC
Contacts	Fine silver (Ag) or 10 µm Gold (Au), microprofile
Terminals	Solder, faston and various PCB terminals (side of housing or side of lid, as well as 1/10" o lin pitch)
Temperature range °C	Between -40°C and +85°C (special version up to 140°C)
Mechanical life	up to 5×10^7 cycles (Actuation: sinusoidal and up to 80% of overtravel)
Protection	Enclosure IP40
Mounting	Side mounting through mounting holes
Actuators	Stainless steel, PA66-GF35
Contact Carrier	CuZn or CuSn

Circuit diagram

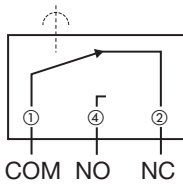

Actuating force/travel

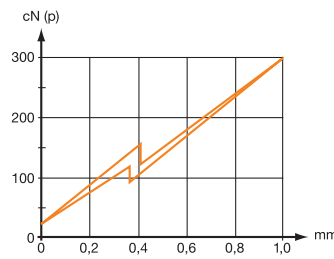

Contact force/travel

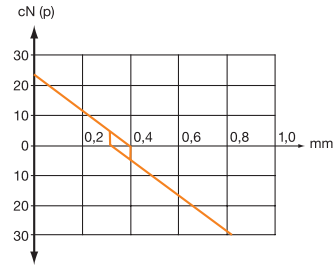

Dimensions

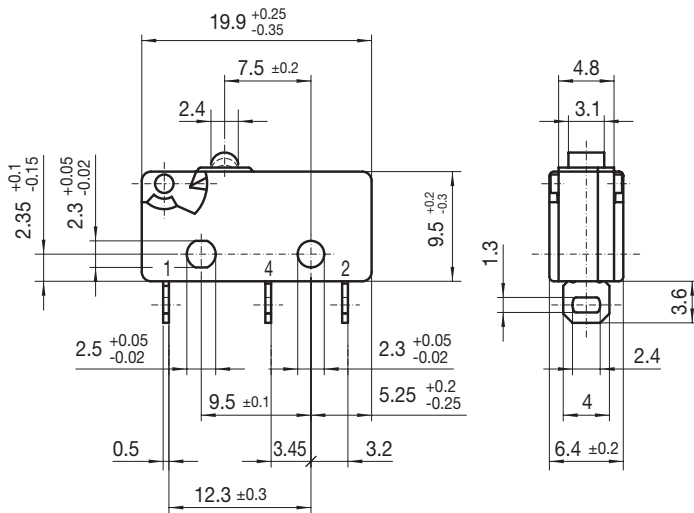

FP = Free Position
OP = Operating Position

Maximum DC rating

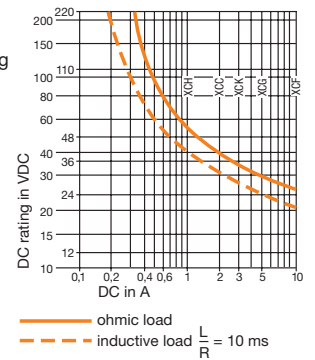

Recommended maximum electrical ratings

Voltage	Resistive load		Motor load (A)	Approvals ENEC		Approvals UL		Motor load	
	(VAC)	(A)		(A)	(VAC)	(A)	(VAC)		
XCF	250	10	3	10 (3)	1E4	250	10,1	125/250	¼ HP
XCG	250	6	2	6 (2)	5E4	250	5	250	—
XCK	250	5	3	5 (3)	1E4	250	5	250	—
XCC	250	3	1	3 (1)	5E4	250	2	250	—
XCH	250	1,5	0,3	1,5 (0,3)	5E4	250	1	250	—

Breaking capacities in the tables refer to Ag contacts.

Operating Characteristics

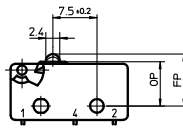
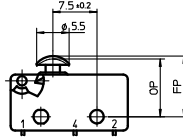
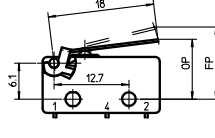
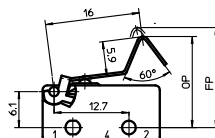
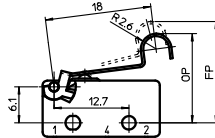
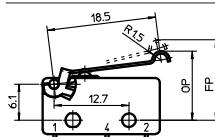
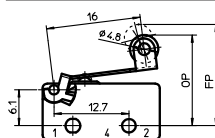
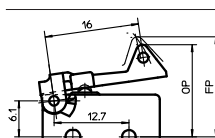
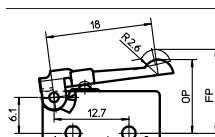
Actuator	Reference	Actuating Force		Release Force		Free Position		Operating Position		Movement Differential		Total travelled position		
		Maximum (N)	(ozf)	Minimum (N)	(ozf)	Maximum (mm)	(in)	(mm)	(in)	Maximum (mm)	(in)	Maximum (mm)	(in)	
	XCF..	3	10,70	0,5	1,78	8,8	0,34	8,4	$\left. \begin{matrix} 0,33 \\ 0,33 \\ 0,33 \\ 0,33 \end{matrix} \right\} \begin{matrix} +0,1 \\ -0,3 \end{matrix}$	$\left. \begin{matrix} 0,33 \\ 0,33 \\ 0,33 \\ 0,33 \end{matrix} \right\} \begin{matrix} +0,003 \\ -0,011 \end{matrix}$	0,1	0,003	7,7	0,303
	XCG..	1,7	6,07	0,3	1,07	8,8	0,34	8,4			0,1	0,003	7,7	0,303
	XCK..	1,2	4,28	0,2	0,71	8,8	0,34	8,4			0,1	0,003	7,7	0,303
	XCC..	0,6	2,14	0,1	0,36	8,8	0,34	8,4			0,1	0,003	7,7	0,303
	XCH..	0,35	1,24	0,07	0,24	8,8	0,34	8,4			0,1	0,003	7,7	0,303
	XCF..-U1	3	10,70	0,5	1,78	10,3	0,41	9,9	$\left. \begin{matrix} 0,39 \\ 0,39 \\ 0,39 \\ 0,39 \end{matrix} \right\} \begin{matrix} +0,1 \\ -0,3 \end{matrix}$	$\left. \begin{matrix} 0,39 \\ 0,39 \\ 0,39 \\ 0,39 \end{matrix} \right\} \begin{matrix} +0,003 \\ -0,011 \end{matrix}$	0,1	0,003	9,2	0,36
	XCG..-U1	1,7	6,07	0,3	1,07	10,3	0,41	9,9			0,1	0,003	9,2	0,36
	XCK..-U1	1,2	4,28	0,2	0,71	10,3	0,41	9,9			0,1	0,003	9,2	0,36
	XCC..-U1	0,6	2,14	0,1	0,36	10,3	0,41	9,9			0,1	0,003	9,2	0,36
	XCH..-U1	0,35	1,24	0,07	0,24	10,3	0,41	9,9			0,1	0,003	9,2	0,36
	XCF..	1,05	3,74	0,16	0,57	12,2	0,48	10,2 ± 1,0	0,401 ± 0,039	0,6	0,023	8,4	0,33	
	XCG..	0,6	2,14	0,08	0,28	12,2	0,48	10,2 ± 0,9	0,401 ± 0,035	0,5	0,019	8,5	0,337	
	XCK..	0,42	1,49	0,056	0,19	12,2	0,48	10,3 ± 0,9	0,405 ± 0,035	0,5	0,019	8,7	0,342	
	XCC..	0,22	0,78	0,025	0,08	12,2	0,48	10,3 ± 0,9	0,404 ± 0,035	0,4	0,015	8,7	0,342	
	XCH..	0,13	0,46	0,02	0,07	12,2	0,48	10,4 ± 0,9	0,409 ± 0,035	0,4	0,015	8,8	0,346	
Width of lever 4,0 mm/0,16 in														
	XCF..	1,1	3,92	0,17	0,6	17,6	0,69	15,6 ± 1,1	0,614 ± 0,043	0,6	0,023	14	0,551	
	XCG..	0,7	2,49	0,09	0,32	17,6	0,69	15,6 ± 1,0	0,614 ± 0,039	0,5	0,019	14,1	0,555	
	XCK..	0,43	1,53	0,058	0,2	17,6	0,69	15,7 ± 1,0	0,618 ± 0,039	0,4	0,015	14,3	0,562	
	XCC..	0,23	0,82	0,026	0,09	17,6	0,69	15,7 ± 1,0	0,618 ± 0,039	0,4	0,015	14,3	0,562	
	XCH..	0,14	0,49	0,021	0,07	17,6	0,69	15,8 ± 1,0	0,622 ± 0,039	0,4	0,015	14,4	0,566	
Width of lever 4,0 mm/0,16 in														
	XCF..	1,05	3,74	0,16	0,57	17,1	0,48	15,1 ± 1,1	0,401 ± 0,039	0,6	0,023	8,4	0,33	
	XCG..	0,6	2,14	0,08	0,28	17,1	0,48	15,1 ± 1,0	0,401 ± 0,035	0,5	0,019	8,5	0,337	
	XCK..	0,42	1,49	0,056	0,19	17,1	0,48	15,2 ± 1,0	0,405 ± 0,035	0,5	0,019	8,7	0,342	
	XCC..	0,22	0,78	0,025	0,08	17,1	0,48	15,2 ± 1,0	0,404 ± 0,035	0,4	0,015	8,7	0,342	
	XCH..	0,13	0,46	0,02	0,07	17,1	0,48	15,3 ± 1,0	0,409 ± 0,035	0,4	0,015	8,8	0,346	
	XCF..	1,05	3,74	0,16	0,57	13,7	0,48	11,7 ± 1,1	0,401 ± 0,039	0,6	0,023	8,4	0,33	
	XCG..	0,6	2,14	0,08	0,28	13,7	0,48	11,7 ± 1,0	0,401 ± 0,035	0,5	0,019	8,5	0,337	
	XCK..	0,42	1,49	0,056	0,19	13,7	0,48	11,8 ± 1,0	0,405 ± 0,035	0,5	0,019	8,7	0,342	
	XCC..	0,22	0,78	0,025	0,08	13,7	0,48	11,8 ± 1,0	0,404 ± 0,035	0,4	0,015	8,7	0,342	
	XCH..	0,13	0,46	0,02	0,07	13,7	0,48	11,9 ± 1,0	0,409 ± 0,035	0,4	0,015	8,8	0,346	
	XCF..	1,1	3,92	0,17	0,6	17,6	0,69	15,6 ± 1,2	0,614 ± 0,047	0,6	0,023	14,1	0,555	
	XCG..	0,7	2,49	0,09	0,32	17,6	0,69	15,6 ± 1,1	0,614 ± 0,043	0,5	0,019	14,2	0,559	
	XCK..	0,43	1,53	0,058	0,2	17,6	0,69	15,7 ± 1,1	0,618 ± 0,043	0,4	0,015	14,4	0,566	
	XCC..	0,23	0,82	0,026	0,09	17,6	0,69	15,7 ± 1,1	0,618 ± 0,043	0,4	0,015	14,4	0,566	
	XCH..	0,14	0,49	0,021	0,07	17,6	0,69	15,8 ± 1,1	0,622 ± 0,043	0,4	0,015	14,5	0,57	
Width of roller 4,0 mm/0,16 in, for high temperature use -T1 lever														
	XCF..	1,3	4,62	0,17	0,6	17,6	0,69	15,6 ± 1,1	0,614 ± 0,043	0,6	0,023	14	0,551	
	XCG..	0,75	2,67	0,09	0,32	17,6	0,69	15,6 ± 1,0	0,614 ± 0,039	0,5	0,019	14,1	0,555	
	XCK..	0,6	2,13	0,058	0,2	17,6	0,69	15,7 ± 1,0	0,618 ± 0,039	0,4	0,015	14,3	0,562	
	XCC..	0,31	1,10	0,026	0,09	17,6	0,69	15,7 ± 1,1	0,618 ± 0,043	0,4	0,015	14,3	0,562	
	XCH..	0,22	0,78	0,021	0,07	17,6	0,69	15,8 ± 1,0	0,622 ± 0,039	0,4	0,015	14,4	0,566	
	XCF..	1,05	3,74	0,16	0,57	14,3	0,56	12,5 ± 1,1	0,49 ± 0,043	0,6	0,023	10,6	0,417	
	XCG..	0,6	2,13	0,08	0,28	14,3	0,56	12,5 ± 1,0	0,49 ± 0,039	0,5	0,019	10,7	0,421	
	XCK..	0,42	1,49	0,056	0,21	14,3	0,56	12,6 ± 1,0	0,5 ± 0,039	0,5	0,015	10,8	0,425	
	XCC..	0,22	0,78	0,025	0,11	14,3	0,56	12,6 ± 1,0	0,5 ± 0,039	0,4	0,015	10,8	0,425	
	XCH..	0,13	0,46	0,02	0,07	14,3	0,56	12,7 ± 1,0	0,5 ± 0,039	0,4	0,015	10,9	0,429	

Ordering Reference

Basic type	XCF	3	N	10,70 ozf	Example: XCF	4	3	V	-81	-J1	Z1
	XCG	1,7	N	6,07 ozf							
	XCK	1,2	N	4,28 ozf							
	XCC	0,6	N	2,14 ozf							
	XCH	0,35	N	1,24 ozf							
Circuits	No symbol, change-over (CO)										
	4	Normally closed (NC)									
	5	Normally open (NO)									
Terminals	3	Solder									
	4	Faston									
	5	Faston									
	8	PCB									
	9	PCB									
	10	PCB									
	11	PCB									
	12	PCB									
	13	PCB									
	14	PCB									
	15	PCB									
Version	No symbol, Housing material MF, Europe up to 85°C, UL up to 90°C										
	V	(High temperature 125°C), Housing material MF / Plunger PBT, Europe up to 125°C, UL up to 130°C									
	W	(High temperature 140°C), Housing material MF / Plunger PPS, Europe up to 140°C, UL up to 150°C									
Contacts	No symbol, Ag (Ag)										
	-81	μ profile Au 10 μm									
	-83	Ag + 0,2 μ Au (gold plated)									
Actuators	No symbol, plunger										
	-J1	Plain lever									
	-J2	Plain lever									
	-J5	Plain lever									
	-S1	Roller lever									
	-L1	Cam follower									
	-L6	Cam follower									
	-L9	Cam follower									
	-P5	Plastic lever									
	-P6	Plastic lever									
	-U1	Mushroom plunger									
	Other actuators on special request.										
Approvals	No symbol, ENEC										
	Z1	UL, CSA									