

Features

- 0.5 INCH CHARACTER HEIGHT.
- LOW CURRENT OPERATION.
- HIGH CONTRAST AND LIGHT OUTPUT.
- EASY MOUNTING ON P.C. BOARDS OR SOCKETS.
- MECHANICALLY RUGGED.
- STANDARD: GRAY FACE, WHITE SEGMENT.
- RoHS COMPLIANT.

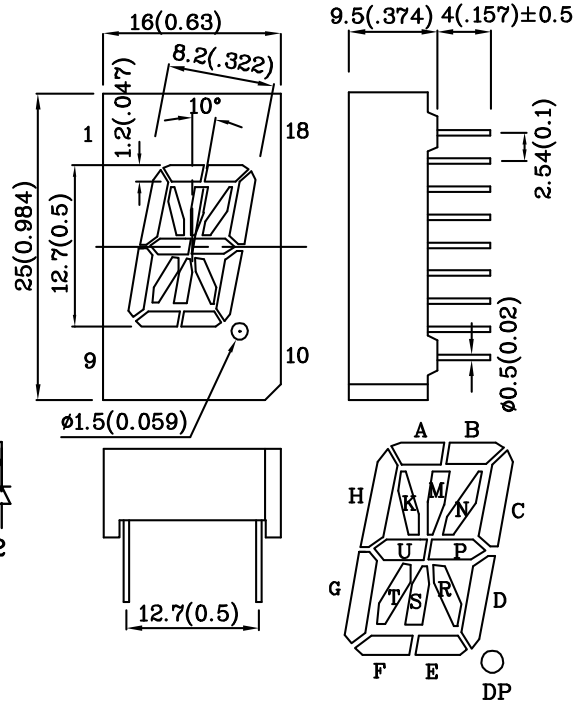
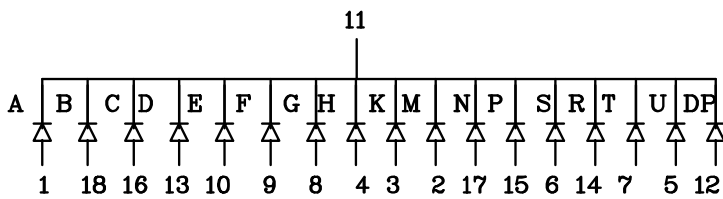

Notes:

1. All dimensions are in millimeters (inches).
2. Tolerance is $\pm 0.25(0.01)$ " unless otherwise noted.

Absolute Maximum Ratings (TA=25°C)		UY (GaAsP/GaP)	Unit
Reverse Voltage	VR	5	V
Forward Current	IF	30	mA
Forward Current (Peak) 1/10 Duty Cycle 0.1ms Pulse Width	iFS	140	mA
Power Dissipation	PT	105	mW
Operating Temperature	TA	-40 ~ +85	°C
Storage Temperature	Tstg	-40 ~ +85	
Lead Solder Temperature [2mm Below Package Base]	260°C For 5 Seconds		

Operating Characteristics (TA=25°C)		UY (GaAsP/GaP)	Unit
Forward Voltage (Typ.) (IF=10mA)	VF	1.95	V
Forward Voltage (Max.) (IF=10mA)	VF	2.5	V
Reverse Current (VR=5V)	IR	10	uA
Wavelength of Peak Emission (IF=10mA)	λ peak	590	nm
Wavelength of Dominant Emission (IF=10mA)	λ D	588	nm
Spectral Line Full Width At Half-Maximum (IF=10mA)	$\Delta\lambda$	35	nm
Capacitance (VF=0V, f=1MHz)	C	20	pF

Part Number	Emitting Color	Emitting Material	Luminous Intensity (IF=10mA) ucd		Wavelength nm λ P	Description
			min.	typ.		
XAUY13C	Yellow	GaAsP/GaP	800	2990	590	Common Cathode, Rt. Hand Decimal

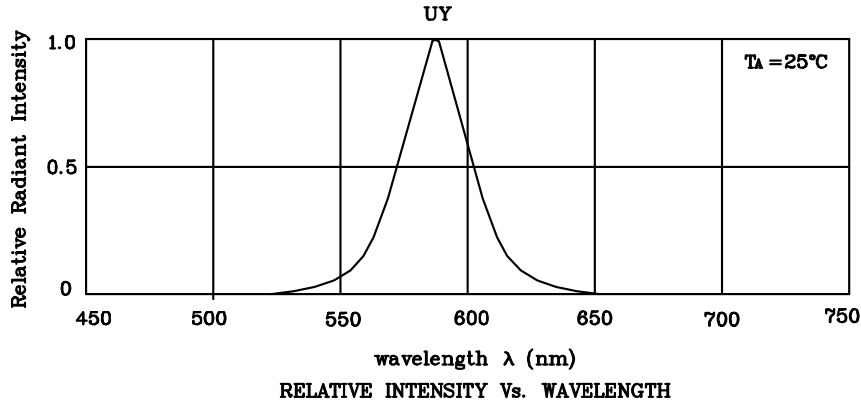

❖ UY

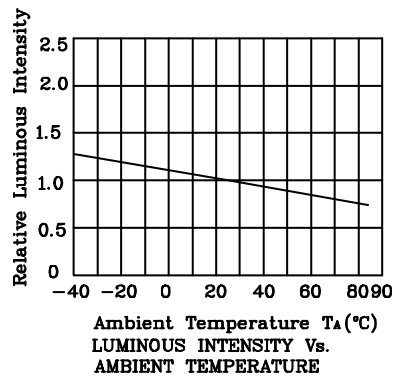
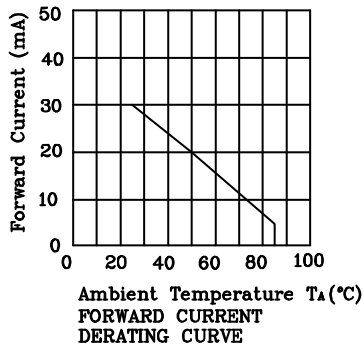
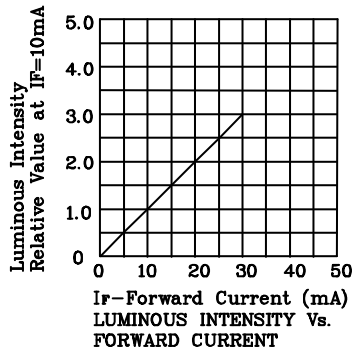
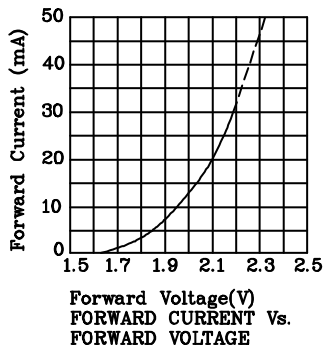

Wave Soldering Profile For Lead-free Through-hole LED.

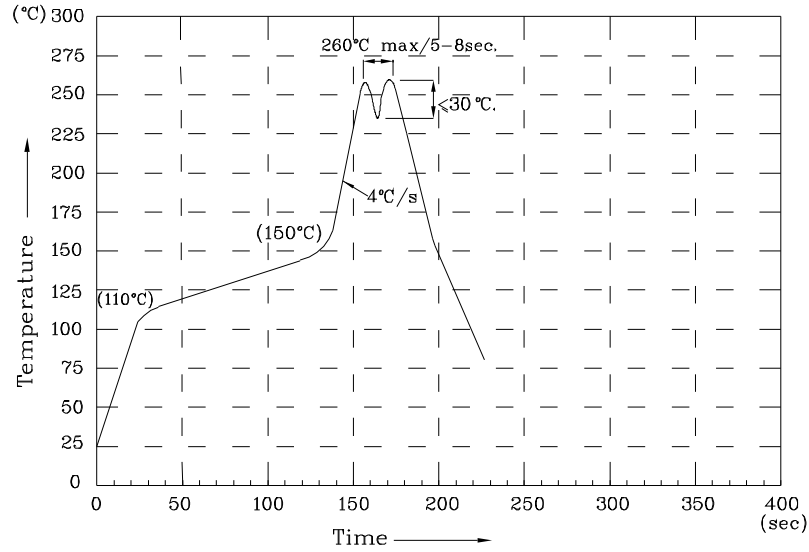

NOTES:

1. Recommend the wave temperature 245°C~260°C. The maximum soldering temperature should be less than 260°C.
2. Do not apply stress on epoxy resins when temperature is over 85 degree°C.
3. The soldering profile apply to the lead free soldering (Sn/Cu/Ag alloy).
4. No more than once.

Remarks:

If special sorting is required (e.g. binning based on forward voltage, luminous intensity, or wavelength), the typical accuracy of the sorting process is as follows:

1. Wavelength: +/-1nm
2. Luminous Intensity: +/-15%
3. Forward Voltage: +/-0.1V

Note: Accuracy may depend on the sorting parameters.