

Pendant control stations

Double insulated, type XAC A

For control circuits

Environment			
Conformity to standards			EN/IEC 60947-5-1 EN/IEC 60204-32, UL 508, CSA C22-2 n° 14 EN/IEC 60947-5-5 and EN/ISO 13850 for versions with trigger action Emergency stop
Product certifications			Special version, with suffix "H7": UL Listed A600-Q600, CSA A600-Q600, CCC, GOST
Protective treatment	Standard version		"TH"
Ambient air temperature	For operation	°C	- 25...+ 70
	For storage	°C	- 40...+ 70
Vibration resistance			15 gn (10...500 Hz) conforming to IEC 60068-2-6
Shock resistance			100 gn conforming to IEC 60068-2-27
Electric shock protection			Class II conforming to IEC 61140
Degree of protection			IP 65 conforming to IEC 60529 IK 08 conforming to EN 50102
Mechanical durability (in millions of operating cycles)			1
Enclosure			Double insulated polypropylene, coloured yellow throughout
Cable entry			Rubber sleeve with stepped entry diameter for cable $\varnothing 8 \dots \varnothing 26$ mm
Contact block characteristics			
Rated operational characteristics	ZB2 BE●●●, XEN G●●●●, XAC S●●●●		~ AC-15: A600 or Ue = 600 V, Ie = 1.2 A or Ue = 240 V, Ie = 3 A --- DC-13: Q600 or Ue = 600 V, Ie = 0.1 A or Ue = 250 V, Ie = 0.27 A
	XEN T●●●●		~ AC-15: A300 or Ue = 240 V, Ie = 3 A --- DC-13: Q300 or Ue = 250 V, Ie = 0.27 A conforming to EN/IEC 60947-5-1 Appendix A
Thermal current (Ithe)		A	10
Rated insulation voltage (Ui)	ZB2 BE●●●, XEN G●●●●, XAC S●●●●		600, degree of pollution 3
	XEN T●●●●		400, degree of pollution 3, conforming to EN/IEC 60947-1
Rated impulse withstand voltage (U imp)		kV	6, conforming to EN/IEC 60947-1
Positive operation			Mushroom head pushbutton: N/C contact with positive opening operation conforming to EN/IEC 60947-5-1 Appendix K
Contact operation			N/C or N/O slow break
Resistance across terminals		MΩ	≤ 25
Operating force		N	Operators - with 1 N/O contact: 10 - with 1 N/C contact: 8 - with additional N/O contact: + 5 - with additional N/C contact: + 3
Terminal referencing			Conforming to CENELEC EN 50013
Short-circuit protection			10 A cartridge fuse type gG (gl)
Connection		mm ²	Screw and captive cable clamp terminals. Clamping capacity: min. 1 x 0.5 mm ² , max., with or without cable end: 2 x 1.5 mm ² or 1 x 2.5 mm ² . 6.3 mm clips (on request), please consult your Customer Care Centre.

Operational power Conforming to EN/IEC 60947-5-1 Appendix C. Utilisation categories AC-15 and DC-13. Operating rate: 3600 operating cycles/hour. Load factor: 0.5.

a.c. supply ~ 50/60 Hz
m. Inductive circuit

d.c. supply ---
Power broken in W for 1 million operating cycles

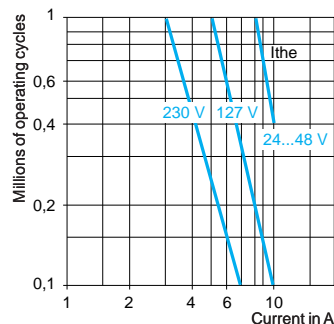

Voltage V	24	48	120
mm W	65	48	40











Pendant control stations

Double insulated, type XAC A

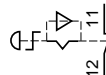
For control circuits

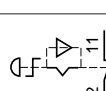
Complete stations “ready for use”

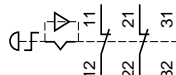
For control of single-speed motors

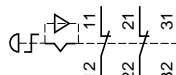
Functions	Number of operators	Contact block(s) and scheme		Reference	Weight kg
		Per direction	For Emergency stop		
	2 mechanically interlocked	1 N/O ZB2 BE101	-	XAC A271	0.475
					
		1 N/C + 1 N/O ZB2 BE102 + ZB2 BE101	-	XAC A281	0.500
					
	2 mechanically interlocked + 1 trigger action latching Emergency stop Ø 30 mm operator	1 N/O ZB2 BE101	1 N/C ZB2 BE102	XAC A2714 (1)	0.575
					
		1 N/C + 1 N/O ZB2 BE102 + ZB2 BE101	1 N/C ZB2 BE102	XAC A2814 (1)	0.600
					
		1 N/O ZB2 BE101	1 N/C + N/C + N/C XEN T1192	XAC A27141 (1)	0.615
					
		1 N/C + 1 N/O ZB2 BE102 + ZB2 BE101	1 N/C + N/C + N/C XEN T1192	XAC A28141 (1)	0.635
					

DF66523



XAC A271
XAC A281

DF66524



XAC A2714
XAC A2814

DF66524



XAC A27141
XAC A28141

(1) Trigger action mechanically latching Emergency stop pushbuttons conform to standards EN/IEC 60204-32, EN/ISO 13850, Machinery directive 98/37/EC and standard EN/IEC 60947-5-5.

Pendant control stations

Double insulated, type XAC A

For control circuits

Complete stations “ready for use”

DF566525



XAC A471
XAC A481

530226



XAC A4714
XAC A4814
XAC A47141
XAC A48141

530224



XAC A671
XAC A681
XAC A6714
XAC A6814

530223



For control of single-speed motors (continued)					
Functions	Number of operators	Contact block(s) and scheme		Reference	Weight kg
		Per direction	For Emergency stop		
	4 mechanically interlocked between pairs	1 N/O ZB2 BE101		-	XAC A471 0.625
		1 N/C + 1 N/O ZB2 BE102 + ZB2 BE101		-	XAC A481 0.675
	4 mechanically interlocked between pairs + 1 trigger action latching Emergency stop Ø 40 mm operator	1 N/O ZB2 BE101		1 N/C ZB2 BE102	
		1 N/C + 1 N/O ZB2 BE102 + ZA2 BS844 (1)		1 N/C ZB2 BE102	
	4 mechanically interlocked between pairs + 1 trigger action latching Emergency stop Ø 40 mm operator	1 N/C + 1 N/O ZB2 BE102 + ZB2 BE101		1 N/C ZB2 BE102	
		1 N/O ZB2 BE101		1 N/C + N/C + N/C XEN T1192	
	4 mechanically interlocked between pairs + 1 trigger action latching Emergency stop Ø 40 mm operator	1 N/C + 1 N/O ZB2 BE102 + ZB2 BE101		1 N/C + N/C + N/C XEN T1192	
		1 N/O ZB2 BE101		1 N/C + N/C + N/C XEN T1192	
	4 mechanically interlocked between pairs + 1 trigger action latching Emergency stop Ø 40 mm operator	1 N/C + 1 N/O ZB2 BE102 + ZB2 BE101		1 N/C + N/C + N/C XEN T1192	
		1 N/O ZB2 BE101		1 N/C + N/C + N/C XEN T1192	
	6 mechanically interlocked between pairs	1 N/O ZB2 BE101		-	XAC A671 0.860
		1 N/C + 1 N/O ZB2 BE102 + ZB2 BE101		-	XAC A681 0.950
	6 mechanically interlocked between pairs + 1 trigger action latching Emergency stop Ø 40 mm operator	1 N/O ZB2 BE101		1 N/C ZB2 BE102	
		1 N/C + 1 N/O ZB2 BE102 + ZA2 BS844 (1)		1 N/C ZB2 BE102	
	6 mechanically interlocked between pairs + 1 trigger action latching Emergency stop Ø 40 mm operator	1 N/C + 1 N/O ZB2 BE102 + ZB2 BE101		1 N/C ZB2 BE102	
		1 N/O ZB2 BE101		1 N/C ZB2 BE102	

(1) Trigger action mechanically latching Emergency stop pushbuttons conform to standards EN/IEC 60204-32, EN/ISO 13850, Machinery directive 98/37/EC and standard EN/IEC 60947-5-5.

Pendant control stations

Double insulated, type XAC A

For control circuits

Complete stations "ready for use"

DF565526







XAC A67141
XAC A68141

DF565527



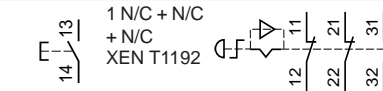

XAC A871
XAC A881

For control of single-speed motors (continued)

Functions	Number of operators	Contact block(s) and scheme		Reference	Weight kg	
		Per direction	For Emergency stop			
 6 mechanically interlocked between pairs + 1 trigger action latching	6 mechanically interlocked between pairs + 1 trigger action latching Emergency stop Ø 40 mm operator ZA2 BS844 (1)	1 N/O ZB2 BE101	1 N/C + N/C + N/C XEN T1192		XAC A67141 (1)	0.880
		1 N/C + 1 N/O ZB2 BE102 + ZB2 BE101	1 N/C + N/C + N/C XEN T1192			
 8 mechanically interlocked between pairs	8 mechanically interlocked between pairs	1 N/O on 7 operators ZB2 BE101 and	-		XAC A871	0.940
		1 N/C on the 8 th operator ZB2 BE102	-			
		1 N/C + 1 N/O ZB2 BE102 + ZB2 BE101	-		XAC A881	1.045

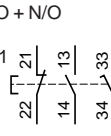
For control of 2-speed motors

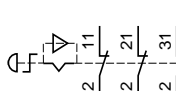
Functions	Number of operators	Contact block(s) and scheme		Reference	Weight kg	
		Per direction	For Emergency stop			
 2 mechanically interlocked between pairs	2 mechanically interlocked between pairs	1 N/C + N/O + N/O staggered XEN G1191	-		XAC A291	0.525
		1 N/C + N/O + N/O staggered XEN G1191	1 N/C ZB2 BE102			
 2 mechanically interlocked between pairs + 1 trigger action latching Emergency stop Ø 30 mm operator ZA2 BS834 (1)	2 mechanically interlocked between pairs + 1 trigger action latching Emergency stop Ø 30 mm operator ZA2 BS834 (1)	1 N/C + N/O + N/O staggered XEN G1191	1 N/C + N/C + N/C XEN T1192		XAC A29141 (1)	0.605
		1 N/C + N/O + N/O staggered XEN G1191	1 N/C + N/C + N/C XEN T1192			

(1) Trigger action mechanically latching Emergency stop pushbuttons conform to standards EN/IEC 60204-32, EN/ISO 13850, Machinery directive 98/37/EC and standard EN/IEC 60947-5-5.

Pendant control stations

Double insulated, type XAC A

For control circuits

Complete stations “ready for use”

For control of 2-speed motors (continued)

Functions	Number of operators	Contact block(s) and scheme	Reference	Weight kg
	4 mechanically interlocked between pairs	1 N/C + N/O + N/O staggered XEN G1191	-	XAC A491 0.625

DF56528



XAC A491

530231

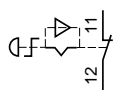
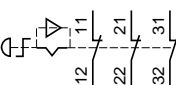

XAC A4914
XAC A49141

	4 mechanically interlocked between pairs + 1 trigger action latching Emergency stop \varnothing 40 mm operator ZA2 BS844 (1)	1 N/C + N/O + N/O staggered XEN G1191	1 N/C ZB2 BE102		XAC A4914 (1) 0.675
		1 N/C + N/O + N/O staggered XEN G1191	1 N/C + N/C + N/C XEN T1192		XAC A49141 (1) 0.700

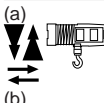
	4 mechanically interlocked between pairs	1 N/C + N/O + N/O staggered (a) XEN G1191	-	XAC A492 0.675
---	--	---	---	----------------

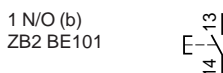

DF56528



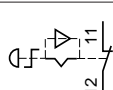

XAC A492

	4 mechanically interlocked between pairs + 1 trigger action latching Emergency stop \varnothing 40 mm operator ZA2 BS844 (1)	1 N/C + N/O + N/O staggered (a) XEN G1191	1 N/C ZB2 BE102		XAC A4924 (1) 0.700
--	--	---	-----------------	---	---------------------

537743

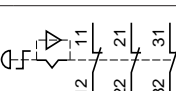

XAC A4924
XAC A49241

		1 N/C + N/O + N/O staggered (a) XEN G1191	1 N/C + N/C + N/C XEN T1192		XAC A49241 (1) 0.735
		1 N/O (b) ZB2 BE101			

(1) Trigger action mechanically latching Emergency stop pushbuttons conform to standards EN/IEC 60204-32, EN/ISO 13850, Machinery directive 98/37/EC and standard EN/IEC 60947-5-5.

Pendant control stations

Double insulated, type XAC A

For control circuits

Empty enclosures

530233



XAC A02

530234



XAC A03

530234



XAC A12

Empty enclosures

Description	Number of cut-outs	Reference	Weight kg
Enclosure comprising: - the enclosure, - internal mounting plate, - protective cable sleeve, - internal cable clamp, - suspension ring, - cable tie (for tightening sleeve onto cable).	2	XAC A02	0.440
	3	XAC A03 (1)	0.440
	4	XAC A04	0.540
	5	XAC A05 (1)	0.625
	6	XAC A06	0.665
	8	XAC A08	0.770
	12	XAC A12	1.000

Variable composition stations, factory assembled

Use the order form on page 30075/17 to define the required configuration.

Equipment: contact blocks, operating heads (control and signalling), complementary accessories

See separate components, page 30075/8

(1) Enclosures with 3 cut-outs XAC A03 and 5 cut-outs XAC A05 cannot be fitted with a mounting adaptor for base mounted units. The first cut-out can only be used for the Emergency stop function.

Pendant control stations

Double insulated, type XAC A

For control circuits

Separate components and spare parts

530238



ZB2 BE101
ZB2 BE102

530237



XEN G1191
XEN G1491

530236



XEN G3781
XEN G3791

530239



XEN T1192

Contact blocks for front mounting

Description	Application	Function	Scheme	Reference	Weight kg
Single block, spring return slow break	Single-speed	N/O		ZB2 BE101	0.015
		N/C		ZB2 BE102	0.015
Double block, latching slow break (2)	N/C + N/O + N/O simultaneous (1)			XEN G1491	0.040
	2-speed	N/C + N/O + N/O staggered (1)		XEN G1191	0.040
Double block, latching slow break (2)	Single-speed	N/O		XEN G3781	0.060
		N/O		XEN G3791	0.060
		N/O		XEN G3791	0.060
		N/C		XEN G3791	0.060

Isolating switch, slow break, for front mounting

For mounting in enclosures	Application	Function	Scheme	Reference	Weight kg
XAC A03 (frontal cut-out) XAC A05, A06, A08 (frontal or base cut-out)	Emergency stop	N/C + N/C + N/C with positive opening operation		XEN T1192	0.050

(1) Only for use with XAC A9●●● operators.

(2) Not suitable for use with the following operating heads: ZA2 BB, ZA2 BD, ZA2 BG and ZA2 BS.

Pendant control stations

Double insulated, type XAC A

For control circuits

Separate components and spare parts

530240

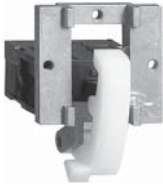

XAC S10●

Contact blocks for base mounting

Description	Function	Scheme	Reference	Weight kg
Spring return slow break (1)	N/O		XAC S101	0.030
	N/C		XAC S102	0.030
	N/O + N/O		XAC S103	0.045
	N/C + N/C		XAC S104	0.045
	N/C + N/O		XAC S105	0.045

530241



ZB2 BV006

Pilot light bodies for front mounting

Description	Supply voltage	Scheme	Reference	Weight kg
Direct supply Bulb not included (2)	≤ 400 V		ZB2 BV006	0.015
Direct supply, through resistor Incandescent BA 9s base fitting 130 V bulb included	230 V		ZB2 BV007	0.020

530242



ZB2 BV007

(1) Not suitable for use with 3-position operating heads ZA2 BD and ZA2 BG or for mounting in enclosures XAC A039 and XAC A03.

(2) Bulb type for use with direct supply units: BA 9s base fitting incandescent bulb $U \leq 130$ V or neon bulb 110 V $\leq U \leq 400$ V. Maximum power: 2.6 W, maximum \varnothing : 11 mm, maximum length: 28 mm. See page 30075-EN/10.

Pendant control stations

Double insulated, type XAC A

For control circuits

Separate components and spare parts

530243



XAC A94●●

Operating heads for front mounting

Description	Colour	Sold in lots of	Unit reference	Weight kg
Booted operators	White	10	XAC A9411	0.010
	Black	10	XAC A9412	0.010
	Green	10	XAC A9413	0.010
	Red	10	XAC A9414	0.010
	Yellow	10	XAC A9415	0.010
	Blue	10	XAC A9416	0.010
	Brown	10	XAC A9419	0.010

530249



ZA2 BS834

Operating heads for front or base mounting

Description	Colour	Type	Reference	Weight kg
Trigger action latching Emergency stop (1) Turn to release	Red	Ø 30 mm	ZA2 BS834	0.040
		Ø 40 mm	ZA2 BS844	0.050
Trigger action latching Emergency stop (2) Key release (n° 455) Key withdrawal in rest (unactuated) position	Red	Ø 30 mm	ZA2 BS934	0.060
		Ø 40 mm	ZA2 BS944	0.065
Selector switches (3), standard handle (Not to be used with XEN G●●●● contact blocks)	Black	2 position, stay put	ZA2 BD2	0.018
		3 position, stay put (4)	ZA2 BD3	0.018
Key switches (2) (key n° 455) Key withdrawal in left and right-hand position	–	2 position, stay put	ZA2 BG4	0.042
		3 position, stay put (4)	ZA2 BG5	0.042
Key switch (2) (key n° 455) Key withdrawal in left-hand position	–	2 position, stay put	ZA2 BG2	0.042
Key switch (2) (key n° 455) Spring return from right to left Key withdrawal in left-hand position	–	2-position	ZA2 BG6	0.042
Key switch (4) (2) (key n° 455) Key withdrawal in centre position	–	3 position, stay put	ZA2 BG3	0.042
Wobblesticks (5) Operates in all directions for fast stop	Black	–	ZA2 BB2	0.060
	Red	–	ZA2 BB4	0.060

DF538483



ZA2 BS944

530245



ZA2 BD●

530246



ZA2 BG●

DF565529



ZA2 BB●

(1) Trigger action mechanically latching Emergency stop pushbuttons conform to standards EN/IEC 60204-32, EN/ISO 13850, Machinery directive 98/37/EC and standard EN/IEC 60947-5-5.

(2) Other key numbers available on request, please consult your Customer Care Centre.

(3) Selector switches available with other mechanical functions, please consult your Customer Care Centre.

(4) Only suitable for front mounting.

(5) Base mounting recommended.

Pendant control stations

Double insulated, type XAC A

For control circuits

Separate components and spare parts

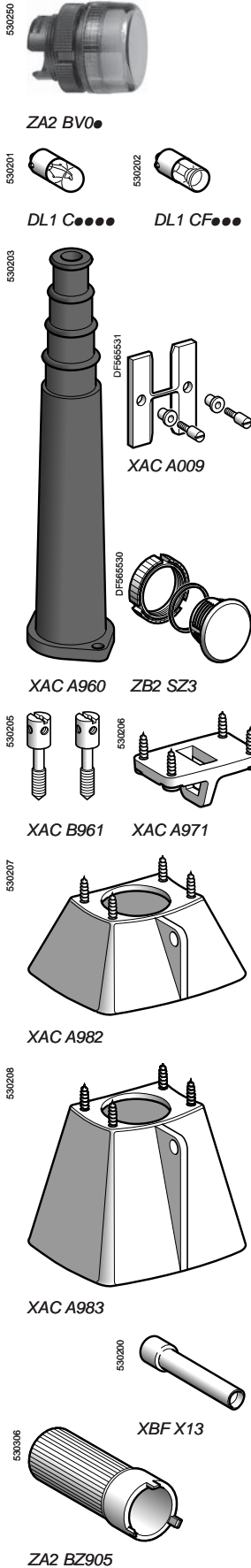

Pilot light heads

Description	Colour	Reference	Weight kg
For use with incandescent bulbs			
Lens cap with bezel and fixing nut	White	ZA2 BV01	0.015
	Green	ZA2 BV03	0.015
	Red	ZA2 BV04	0.015
	Yellow	ZA2 BV05	0.015
	Blue	ZA2 BV06	0.015
	Clear	ZA2 BV07	0.015

For use with neon bulbs

Lens cap with bezel and fixing nut	Green	ZA2 BV033	0.015
	Red	ZA2 BV043	0.015
	Yellow	ZA2 BV053	0.015
	Clear	ZA2 BV073	0.015

Bulbs

Description	Voltage	Sold in lots of	Unit reference	Weight kg
Incandescent BA 9s base fitting Maximum power: 2.6 W Maximum Ø: 11 mm Maximum length: 28 mm	6 V	10	DL1 CB006	0.002
	12 V	10	DL1 CE012	0.002
	24 V	10	DL1 CE024	0.002
	48 V	10	DL1 CE048	0.002
	130 V	10	DL1 CE130	0.002
	110 V	10	DL1 CF110	0.002
Neon BA 9s base fitting Maximum power: 2.6 W Maximum Ø: 11 mm Maximum length: 28 mm	230 V	10	DL1 CF220	0.002
	400 V	10	DL1 CF380	0.002

Complementary accessories, tools

Description	Reference	Weight kg
Protective cable sleeve	For cable Ø 8 to 22 mm	XAC A950 0.070
	For cable Ø 8 to 26 mm	XAC A960 0.090
Mechanical interlock for 2 operators	With fixing screws	XAC A009 0.003
Blanking plug	With seal and fixing nut	ZB2 SZ3 0.005
Tightening tool for fixing nut	–	ZA2 BZ905 0.060
Adaptor for self-supporting cable type BBAP	Mounted with protective sleeve for cable Ø 8 to 26 mm	XAC B961 0.025
Lower support ring	–	XAC A971 0.010
Protective guards for base mounted units	For selector switch (standard handle) or Emergency stop head pushbutton	XAC A982 0.025
	For key switch or key release latching Emergency stop head pushbutton	XAC A983 0.045
Bulb extractor	For BA 9s base fitting bulbs	XBF X13 0.025

Pendant control stations

Double insulated, type XAC A

For control circuits

Legends 30 x 40 mm with symbols conforming to NF E 52-124

530209

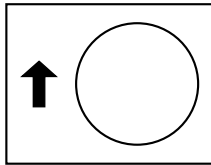

White background, black symbol

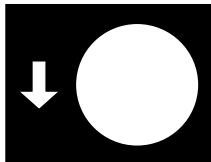

Black background, white symbol

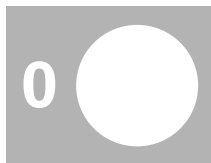

Red background, white symbol

Function Symbol	Reference	Weight kg	Function Symbol	Reference	Weight kg
	ZB2 BY4901	0.001		ZB2 BY2904	0.001
	ZB2 BY4902	0.001		ZB2 BY2905	0.001
	ZB2 BY4903	0.001		ZB2 BY2906	0.001
	ZB2 BY4907	0.001		ZB2 BY2910	0.001
	ZB2 BY4908	0.001		ZB2 BY2911	0.001
	ZB2 BY4909	0.001		ZB2 BY2912	0.001
	ZB2 BY4913	0.001		ZB2 BY2916	0.001
	ZB2 BY4914	0.001		ZB2 BY2917	0.001
	ZB2 BY4915	0.001		ZB2 BY2918	0.001
	ZB2 BY4919	0.001		ZB2 BY2922	0.001
	ZB2 BY4920	0.001		ZB2 BY2923	0.001
	ZB2 BY4921	0.001		ZB2 BY2924	0.001
	ZB2 BY4933	0.001		ZB2 BY4934	0.001
	ZB2 BY4932	0.001		ZB2 BY4935	0.001
	ZB2 BY4930	0.001		ZB2 BY2931	0.001

Pendant control stations

Double insulated, type XAC A

For control circuits

Legends 30 x 40 mm

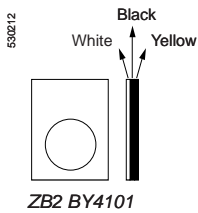
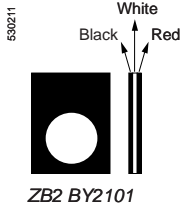

Text	Reference	Weight kg	Text	Reference	Weight kg
<ul style="list-style-type: none"> ■ Start functions: white characters on black background ■ Stop functions: white characters on red background 					
Blank					
Black or red background	ZB2 BY2101	0.001	White or yellow background	ZB2 BY4101	0.001
With English text			With French text		
For pushbuttons			For pushbuttons		
Start	ZB2 BY2303	0.001	Marche	ZB2 BY2103	0.001
Stop	ZB2 BY2304	0.001	Arrêt	ZB2 BY2104	0.001
Forward	ZB2 BY2305	0.001	Avant	ZB2 BY2105	0.001
Reverse	ZB2 BY2306	0.001	Arrière	ZB2 BY2106	0.001
Up	ZB2 BY2307	0.001	Montée	ZB2 BY2107	0.001
Down	ZB2 BY2308	0.001	Descente	ZB2 BY2108	0.001
Right	ZB2 BY2309	0.001	Droite	ZB2 BY2109	0.001
Left	ZB2 BY2310	0.001	Gauche	ZB2 BY2110	0.001
On	ZB2 BY2311	0.001	En service	ZB2 BY2111	0.001
Off	ZB2 BY2312	0.001	Hors service	ZB2 BY2112	0.001
Power on	ZB2 BY2326	0.001	Sous tension	ZB2 BY2126	0.001
Slow	ZB2 BY2327	0.001	Lent	ZB2 BY2127	0.001
Fast	ZB2 BY2328	0.001	Vite	ZB2 BY2128	0.001
Klaxon	ZB2 BY2125	0.001	Klaxon	ZB2 BY2125	0.001
For selector switches			For selector switches		
-	-	0.001	Arrêt-Marche	ZB2 BY2166	-
Off-On	ZB2 BY2367	0.001	Hors-en	ZB2 BY2167	0.001
With special texts					
<ul style="list-style-type: none"> ■ Specify text when ordering, ■ 2 lines maximum, 11 characters per line. 					
White characters on black background	ZB2 BY2002	0.001	Black characters on white background	ZB2 BY4001	0.001
White characters on red background	ZB2 BY2004	0.001	Black characters on yellow background	ZB2 BY4005	0.001
Other versions	Legends with texts in other languages. Please consult your Customer Care Centre.				

Pendant control stations

Double insulated, type XAC A
For control circuits

Dimensions

XAC A pendant stations for control circuits

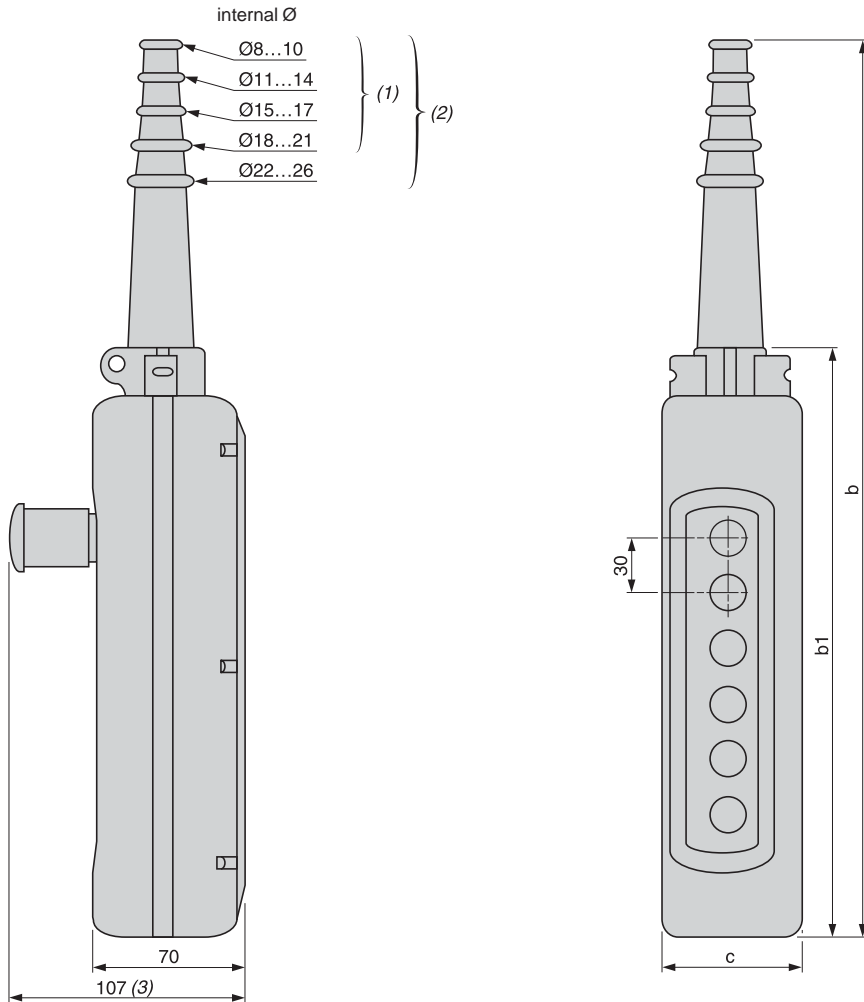

Number of operators	2	3	4	5	6	8	12
b	314	314	440	440	500	560	680
b1	190	190	250	250	310	370	490
c	80	80	80	80	80	80	92

(1) For 2 and 3-way XAC A stations.
 (2) For 4 to 8-way XAC A stations.
 (3) With trigger action Emergency stop head operator.

Protective guards

XAC A982

XAC A983

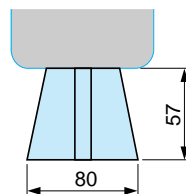
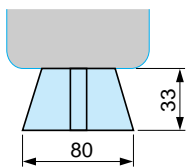

Application schemes (typical examples)

For control of single-speed reversing motor

Contact blocks ZB2 BE101 + ZB2 BE102

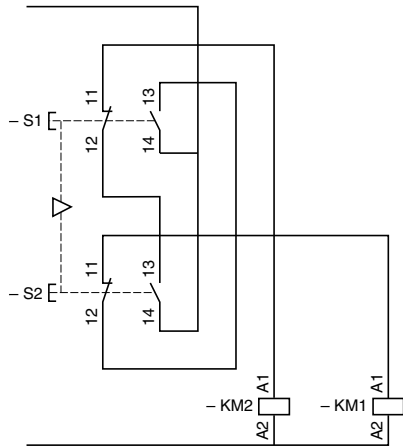

For control of 2-speed reversing motor

2 contact blocks XEN G1191

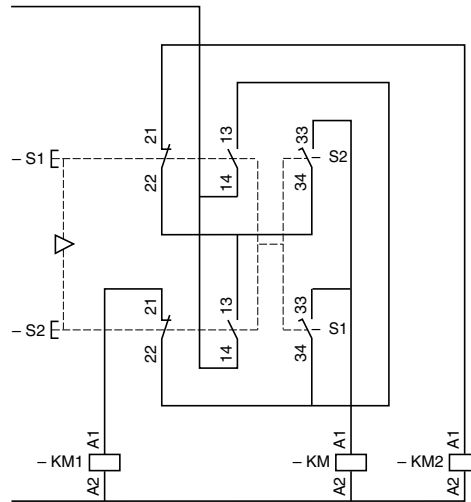

KM: high speed contactor

Pendant control stations

Double insulated, type XAC A

For control circuits

Variable composition stations, factory assembled

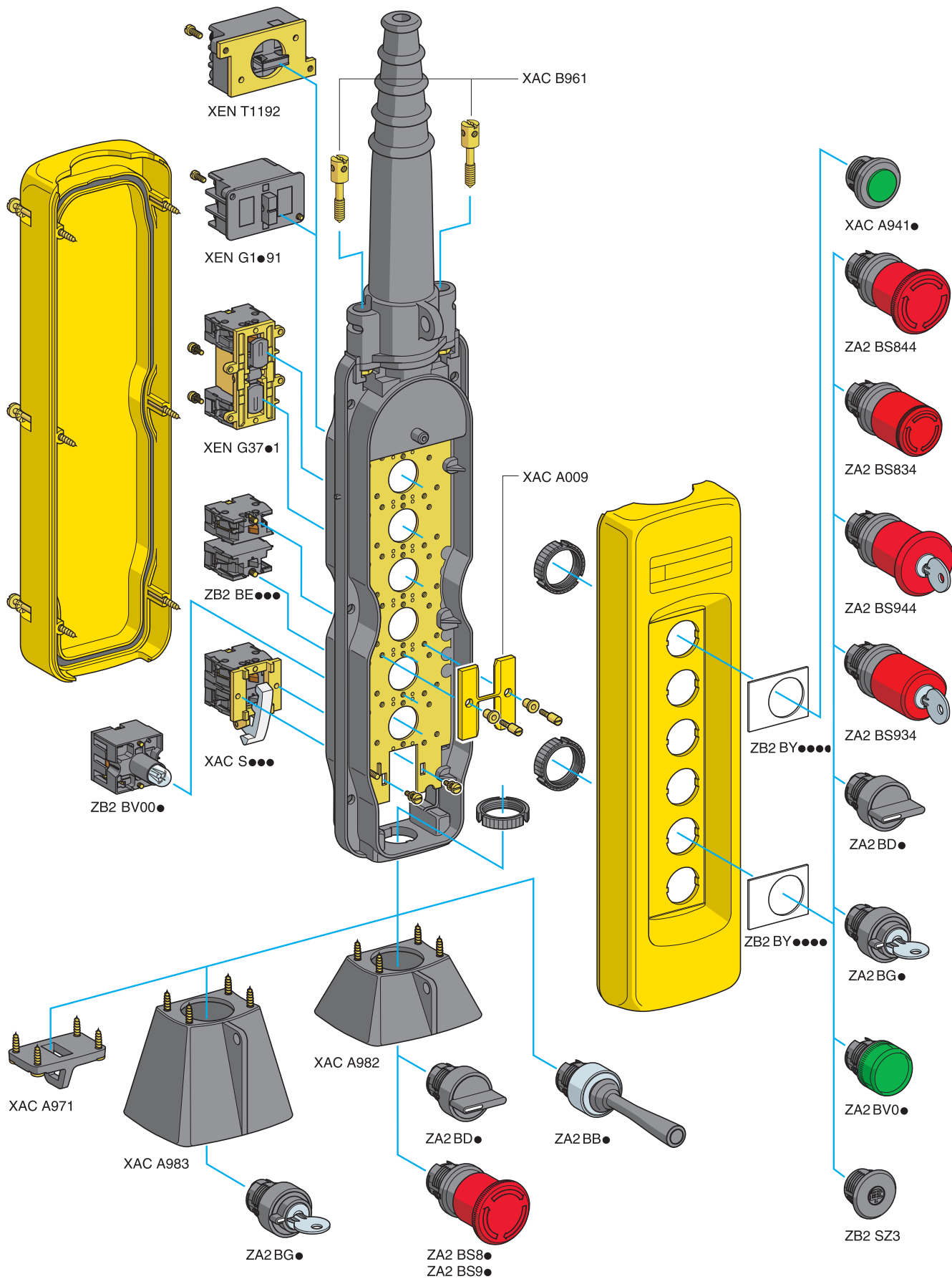

Pendant control stations

Double insulated, type XAC A
For control circuits
Variable composition stations, factory assembled

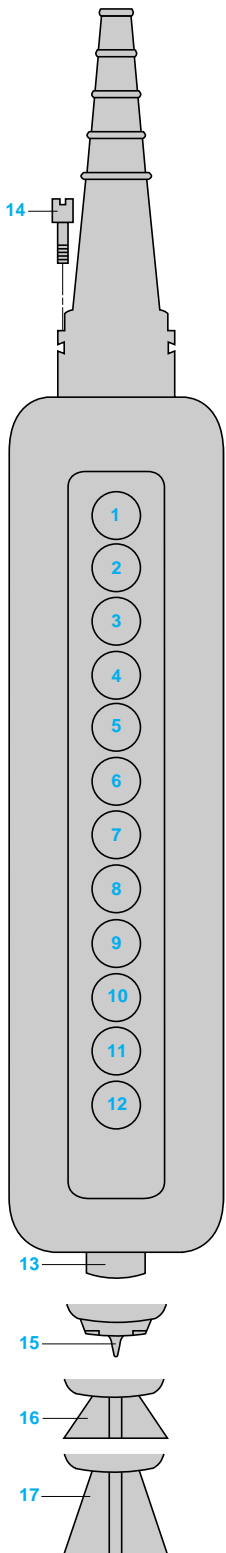

Customer			Schneider Electric Industries	
Company	Order N°	Delivery date	Sales office - Subsidiary Co.	Order N°

Enter the order with XAC A09 reference

Unit reference of empty enclosure, see page 30075/7	Number of identical stations	Enclosure price (1)
XAC <input type="text" value="A"/> <input type="text" value=""/> <input type="text" value=""/>		

Legends see page 30075/12		Contact blocks or pilot light bodies see page 30075/8		Operating heads or pilot light heads or blanking plug see page 30075/10		Total price
Reference	Unit price	Reference	Unit price	Reference	Unit price	
1						
2						
3						
4						
5						
6						
7						
8						
9						
10						
11						
12						

Unit mounted in base of enclosure (if required) (Except when using XAC A03 and XAC A05)

13						
----	--	--	--	--	--	--

Complementary accessories, see page 30075/11 (cross the appropriate box or boxes)

Description	<input checked="" type="checkbox"/>	Reference	Unit price
14 Adaptor for self-supporting cable type BBAP for use with cable entry sleeve Ø 8 to 26 mm		XAC B961	
15 Lower support ring		XAC A971	
16 Protective guard for selector switch (std. handle) or Emergency stop head pushbutton, mounted in base		XAC A982	
17 Protective guard for key switch or key release Emergency stop head pushbutton, mounted in base		XAC A983	

Mechanical interlocking (2)

Reference	Quantity	Unit price
XAC A009		
Factory assembly:	Number of heads or blanking plugs to be fitted	Additional cost XAC 9VA for fitting of 1 head or 1 blanking plug
	<input type="text" value=""/> X <input type="text" value=""/>	<input type="text" value=""/>

Total price of assembled pendant station

(1) Obtain the empty enclosure price.
(2) Connect with a line the 2 ways which require mechanical interlocking.

Examples: combinations possible

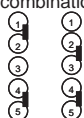

Combinations not possible

