

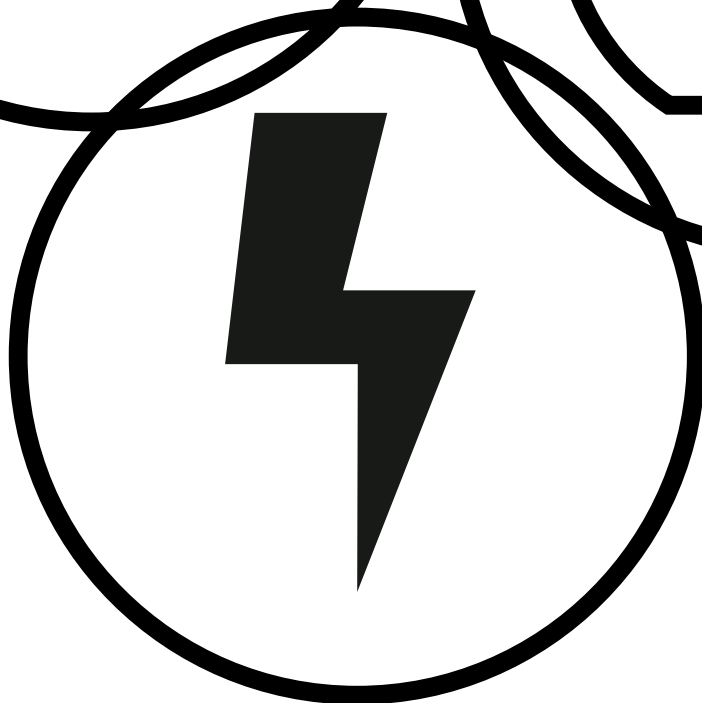

**WORLD PRODUCTS INC.**  
ELECTRONIC COMPONENT SOLUTIONS

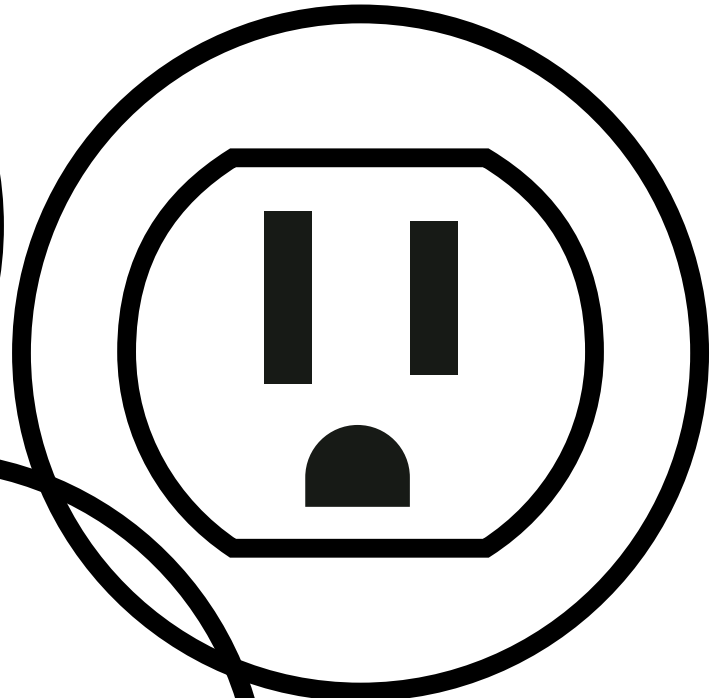

# RFI SUPPRESSORS

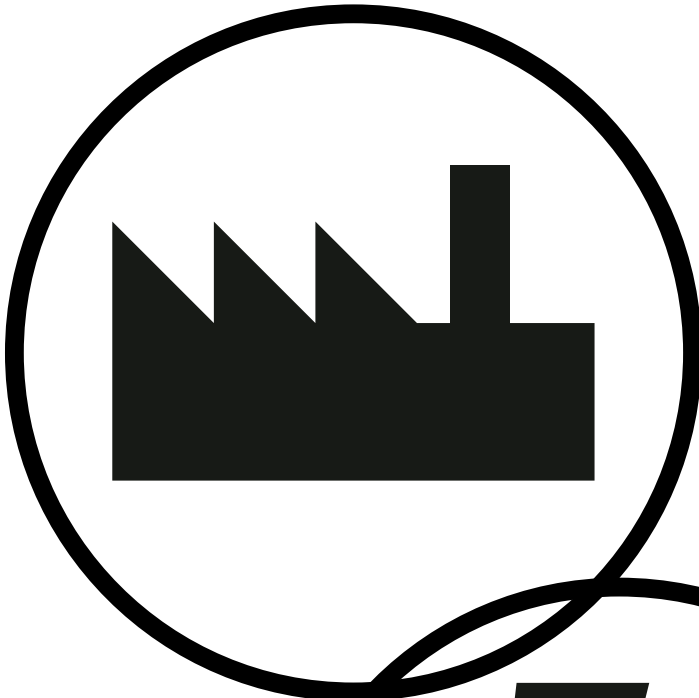

# RFI SUPPRESSORS

## RFI SUPPRESSORS

World Products' Metallized Polypropylene and Polyester RFI Suppressors are intended for use on line-to-line (X2) and line-to-ground (Y2) AC Mains. Our proprietary construction method allows these devices to withstand the stresses of high voltage transient pulses and remain safe according to international safety standards without degradation of performance. They are constructed of the finest materials available for the purpose of providing maximum reliability and long life. Stringent quality controls are used throughout production.

These suppressors are designed to suppress radio interference, conducted on the AC mains, generated from household appliances, computers, switch mode power supplies, and other electronic equipment. They are available in a wide range of capacitance values and industry standard case sizes.

Featuring...

- International Safety Approvals
- Excellent Self Healing Properties
- High Dv/Dt Ratings
- Flame Retardant Encapsulation
- 100% Production Lot Testing
- Standard Electrical AQL - 0.065
- RoHS Compliance commencing July 2005

## Table of Contents

|                               |     |
|-------------------------------|-----|
| General Information           | 184 |
| Technical Specifications      | 186 |
| Typical Resonant Frequencies  | 187 |
| WXP, WXPC, WYP Specifications | 188 |
| WYE Specifications            | 191 |
| Taping Specifications         | 193 |
| Marking and Safety Approvals  | 195 |

## General Information

### Product Description

RFI suppressors are a special class of capacitors for use on the AC power line inputs to electronic or electrical equipment. Their purpose is to eliminate or attenuate radio frequency interference voltages originated in the units connected to the same AC power branch and prevent them from mutually disturbing their operations.

They must endure very harsh conditions existing on the 60/50Hz AC power lines — including voltage surges and transients. Therefore, they must meet the requirements of EN 132-400 and IEC 384-14, 2nd edition 1993 standards enforced by international safety certification bodies, as well as UL-1414 and UL-1283 in USA.

Our RFI capacitors are made with metallized polypropylene or polyester films of the highest quality and have self healing properties. There are two classes of these capacitors: Line-to-Line X2 Class, and Line-to-Ground Y2 Class.

We have three series of X2 — WXP and WXPC series rated at 300VAC and \*275VAC — and two series of Y2 — WYP and WYE rated at 275VAC and 250 VAC. WXP, WXPC (smaller dimensions) and WYP series are made with polypropylene film. WYE series is made with polyester film.

While polypropylene and polyester series are compatible, polypropylene dielectrics are more popular worldwide and have smaller dissipation factor (DF) improving operation at higher frequencies. Also, due to larger production volumes polypropylene capacitors are less expensive.

World Products has excelled in serving customer needs, providing a full line of protection products. We also offer to our customers the technical support of our Applications Laboratory equipped with industry standard, test equipment that can duplicate most safety agency testing.

**Our manufacturing plant has received the Certificate of Quality Assurance System according to the ISO9001 standard.**

We invite you to contact World Products and put us to the test. We can best prove our “commitment to excellence” by actually working for you.

\* 2.2-6.8μF rated at 300VAC (600VDC).

## RoHS Compliance

|             |                                   |
|-------------|-----------------------------------|
| <b>WXPC</b> | 0.010 to 1.5μF/275VAC class X2    |
| <b>WXPC</b> | 2.2 to 6.8μF/300VAC class X2      |
| <b>WXP</b>  | 0.010 to 2.2μF/300VAC class X2    |
| <b>WYP</b>  | 0.010 to 0.1μF/275VAC class Y2    |
| <b>WYE</b>  | 0.001 to 0.0068μF/250VAC class Y2 |

This is to certify that the above mentioned RFI suppressors purchased from World Products Inc. comply to a maximum concentration value of 0.1% by weight in homogeneous materials for lead (Pb), mercury, hexavalent chromium, polybrominated biphenyls (PBB) and polybrominated diphenyl ethers (PBDE) and of 0.01% weight in homogeneous materials for cadmium and are in compliance with Directive 2002/95/EC of the European Parliament and of the Council of 27 January 2003 on the restriction of the use of certain hazardous substances in electrical and electronic equipment (RoHS Directive) as of July 2005 (date code marking starting 0527). Additionally “R” marking (per marking specification) is initiated starting with date code 0544 to further identify RoHS compliant products.

### Note

All our capacitors listed below have Climatic Category: IEC 40/100/56 C, and Operating Temperature Range: -40 to +100°C

## General Information — continued

### Metallized Polypropylene Film Capacitors

|                   | X2 - WXP                   | X2 - WXPC                  |                                  | Y2 - WYP                   |
|-------------------|----------------------------|----------------------------|----------------------------------|----------------------------|
| Capacitance Range | 0.01 - 2.2 $\mu$ F         | 0.01 - 1.5 $\mu$ F         | 2.2 - 6.8 $\mu$ F                | 0.01 - 0.1 $\mu$ F         |
| Rated Voltage     | 300VAC<br>50/60Hz to 440Hz | 275VAC<br>50/60Hz to 440Hz | 300VAC<br>50/60Hz to 440Hz       | 275VAC<br>50/60Hz to 440Hz |
| Tolerance         | $\pm$ 10% - $\pm$ 20%      | $\pm$ 10% - $\pm$ 20%      | $\pm$ 5% - $\pm$ 10% - $\pm$ 20% | $\pm$ 20%                  |

### Metallized Polyester Film Capacitors

|                   | Y2 - WYE              |
|-------------------|-----------------------|
| Capacitance Range | .001 – 0.0068 $\mu$ F |
| Rated Voltage     | 250VAC 50/60Hz        |
| Tolerance         | $\pm$ 20%             |

## Definition of Terms

### Capacitance

Capacitance values are measured and specified for 1KHz at 25°C

### Dissipation Factor (DF)

The measure of the suppressor's dielectric loss at 1KHz also called tangent of loss angle. It is the ratio of loss power to the reactive power across capacitor that is customarily expressed in % (Ratio =  $\tan F = .01 \rightarrow DF = 1\%$ ). At large DF and operation above specified limits loss power may cause significant internal heating leading to destructive breakdown. All of our suppressors are designed and made with top quality materials to minimize DF.

### Insulation Resistance (IR)

Measurement of the specified IR is made after applying 100 VDC for one minute at 25°C. The proprietary multiple dielectric design of our suppressors provides higher insulation resistance than single dielectric suppressors.

### Climatic Category

According to international safety standards, IEC 60384-14, and IEC 60068-2, suppressors must be categorized according to the rated lowest temperature / the rated highest temperature / the number of days samples are subjected to damp humidity test — in our case: 56 days — which is the absolute maximum rating category.

### Rated Voltage

The rated voltage is the maximum RMS AC voltage which can be applied continuously within the specified Rated Temperature range.

### Rated Temperature Range

The maximum low and high ambient temperature at which the rated voltage can be continuously applied.

### Endurance Life Test

Production samples are subjected to a periodic life endurance testing to comply with international safety approval standards. These tests specify that the suppressor shall have 1.25 x rated voltage (X2) and 1.7 x rated voltage (Y2) applied for a period of 1,008 hours at an elevated temperature of 100°C. We test our WYE suppressors with the above endurance voltages, not only at the time of type approval, but also at 6 month intervals. In addition to the above voltages applied constantly, 1000 VAC is applied once each hour for 0.1 second. Both the steady state and momentary (0.1 sec) 1000 VAC voltage is applied through a 47 ohm  $\pm$  5% resistor simulating the high frequency impedance of AC mains. After the endurance life test, capacitance shall not deviate more than 5% of the initial value, IR shall not be less than 50% of the initial value and DF shall not be greater than the specified. The combined stress of both voltages applied is proof that these suppressors are capable of withstanding high line conditions that are often present on the AC mains.

### dv/dt

The maximum acceptable voltage rate of change per  $\mu$ sec of rise or fall time as defined below:

$$dv/dt = \frac{VR}{R \times C}$$

VR = Rated DC Voltage

R = Discharge Resistor

C = Capacitance Tested

## Technical Specifications

### Electrical Specifications

|                                   |   |  |           |
|-----------------------------------|---|--|-----------|
| <b>Dissipation Factor (DF)</b>    | WYE = $\leq 0.8\%$ at 1KHz  |  |           |
| <b>Insulation Resistance (IR)</b> | $> = 30000$ Mohm for $C_R \leq 0.33\mu\text{F}$   |  |           |
|                                   | $> = 10000$ Ohm Farads for $CR > 0.33\mu\text{F}$<br>Measured at 100 VDC after 60 seconds at +25°C. |  |           |
| <b>Test Voltage</b>               | WYE - Y2 Class  | 3000VDC $C_R \leq 0.0047\mu\text{F}$<br>2700 VDC $C_R = 0.0068\mu\text{F}$ | 2 seconds |
|                                   | WXP - X2 Class  | 2150 VDC for all   | 1 second  |
|                                   | WXPC - X2 Class   | 2150 VDC for all   | 1 second  |
|                                   | WYP - Y2 Class  | 2700 VDC for all   | 2 seconds |

Our factory tests each production lot for 100% to the test voltages listed above. After the test voltage has been applied, 100% of all production is tested for DF, IR and capacitance to insure all suppressors comply with electrical specifications.

### Mechanical Specifications

|                      |                           |  |
|----------------------|---------------------------|--|
| <b>Dimensions</b>    | See Specification Tables  |  |
| <b>Vibration</b>     | IEC 68 - 2 - 6, test FC   | 3 directions at 2 hours each<br>10-500 Hz at 98 m/s <sup>2</sup>   |
| <b>Bump</b>          | IEC 68 - 2 - 29, test Eb  | 4000 Bumps at 390 m/s <sup>2</sup>   |
| <b>Solderability</b> | IEC 60068-2-20 (Method 2) |  |
| <b>Fire Hazard</b>   | UL1414<br>IEC 695 - 2 - 2 | According to Section 18 in this Standard<br>P $> = 15\text{mm}$ , 120 seconds<br>P $< = 15\text{mm}$ , 60 seconds. |
| <b>Humidity</b>      | IEC 68 - 2 - 3, test Ca   | X Class 56 days.<br>Y Class 56 days.   |
| <b>Plastic Case</b>  | UL 94V - 0                | Flame Retardant, Molded Plastic,<br>Epoxy Resin Sealed.  |

### Dissipation Factor (DF)

WXP and WXPC —  $\leq 0.10\%$  at 10kHz for  $C_R \leq 0.1\mu\text{F}$   
—  $\leq 0.50\%$  at 10kHz for  $C_R \leq 1.0\mu\text{F}$   
—  $\leq 0.10\%$  at 1kHz for  $C_R > 1.0\mu\text{F}$

WYP —  $\leq 0.08\%$  at 10kHz

( $C_R$  — Capacitance Range)

## Typical Resonant Frequencies

### Y2 Class Resonant fo

| Type     | C(µf)  | fo - MHz |
|----------|--------|----------|
| WYE-102M | 0.0010 | 53       |
| WYE-152M | 0.0015 | 42       |
| WYE-222M | 0.0022 | 35       |
| WYE-252M | 0.0025 | 33       |
| WYE-332M | 0.0033 | 29       |
| WYE-392M | 0.0039 | 25       |
| WYE-472M | 0.0047 | 21       |
| WYE-682M | 0.0068 | 19       |
| WYP-103M | 0.0100 | 15       |
| WYP-153M | 0.0150 | 12       |
| WYP-223M | 0.0220 | 10       |
| WYP-273M | 0.0270 | 8.1      |
| WYP-333M | 0.0330 | 6.9      |
| WYP-473M | 0.0470 | 5.5      |
| WYP-683M | 0.0680 | 4.7      |
| WYP-104M | 0.1000 | 4.0      |

### X2 Class Resonant fo (WXP and WXPC)

| Type            | C(µf) | fo - MHz |
|-----------------|-------|----------|
| ****-103K       | 0.010 | 13.0     |
| ****-153K       | 0.015 | 10.4     |
| ****-223K       | 0.022 | 8.5      |
| ****-333K       | 0.033 | 6.9      |
| ****-473K       | 0.047 | 6.0      |
| ****-683K       | 0.068 | 4.7      |
| ****-104K       | 0.100 | 4.0      |
| ****-154K       | 0.150 | 3.4      |
| ****-224K       | 0.22  | 2.7      |
| WXPC-274K(only) | 0.27  | 2.5      |
| ****-334K       | 0.33  | 2.3      |
| ****-474K       | 0.47  | 1.9      |
| ****-684K       | 0.68  | 1.6      |
| ****-105K       | 1.00  | 1.3      |
| ****-155K       | 1.50  | 1.0      |
| ****-225K       | 2.20  | 0.85     |

\*\*\*\* = WXP, WXPC

1. All measurements are based on 5mm lead lengths at nominal C values.
2. Actual resonant frequencies will depend also on the total length of the circuit connections to the capacitor terminals and capacitor's actual C value. The tolerances for our capacitors are: ±10% for WXP, WXPC series of X2 class. ±20% for WYE, WYP Series Y2 class.
3. WYE is made with metallized polyester film. WXP, WXPC and WYP are made with metallized polypropylene film.

## WXP, WXPC, WYP Specifications

### Physical Dimensions for WXP, WXPC, WYP

#### Insulated Leads Versions

Only WXP and WXPC

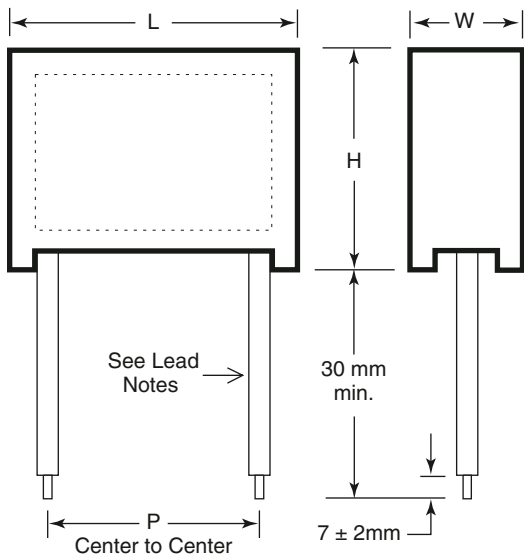

#### Uninsulated Leads Versions

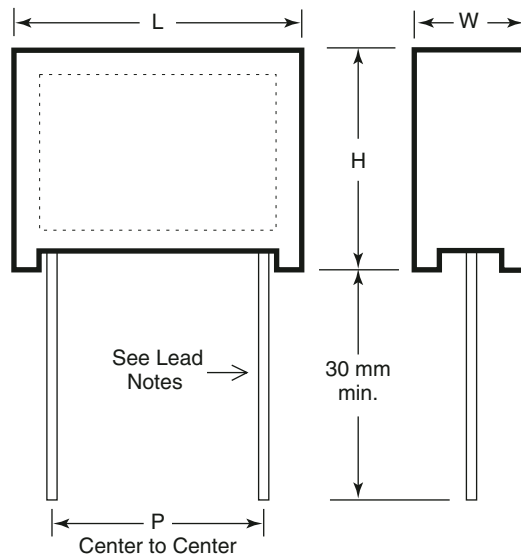

Available with uninsulated or insulated leads

#### Lead Notes:

1. All insulated leads have 7.0mm striped and tinned ends.

| <b>Standard Lead Lengths</b>                 |                                 |   |
|--|---------------------------------|---|
| Standard (No suffix)                         | 35mm $\pm$ 5mm long leads       | Solid uninsulated wire $\phi = 0.8\text{ mm}$ |
| *Suffix 02                                   | 35mm $\pm$ 5mm solid cu wire    | 0.8 mm diameter, PCV insulated                |
| *Suffix 03                                   | 35mm $\pm$ 5mm stranded cu wire | 0.5 mm <sup>2</sup> PCV insulated             |
| <b>Lead-Cut Modifications (suffix codes)</b> |                                 |   |
| L04  | 4mm $\pm$ 1mm                   | Any lead type stated above                    |
| L05  | 5mm $\pm$ 1mm                   | Any lead type stated above                    |
| L06  | 6mm $\pm$ 1mm                   | Any lead type stated above                    |

\* Can only be provided for types with 15mm or larger lead spacing. If lead length other than standard 35mm is required that lead length is noted after the appropriate suffix 02 or 03 (i.e.: for 45mm lead length 02(45) or 03(45).)



## WXP, WXPC, WYP Specifications — continued

### WXP Specifications

| Part Number | Cap. (µF) | L ±0.3 mm | H ±0.3 mm | W ±0.3 mm | P mm     | Quantity Per Box  |                      |
|-------------|-----------|-----------|-----------|-----------|----------|-------------------|----------------------|
|             |           |           |           |           |          | Long Lead 30-35mm | Short Lead 4, 5, 6mm |
| WXP-103K    | 0.010     | 18.0      | 10.5      | 5.5       | 15.0±0.5 | 500               | 1300                 |
| WXP-153K    | 0.015     | 18.0      | 10.5      | 5.5       | 15.0±0.5 | 500               | 1300                 |
| WXP-223K    | 0.022     | 18.0      | 10.5      | 5.5       | 15.0±0.5 | 500               | 1300                 |
| WXP-333K    | 0.033     | 18.0      | 10.5      | 5.5       | 15.0±0.5 | 500               | 1300                 |
| WXP-473K    | 0.047     | 18.0      | 12.5      | 6.5       | 15.0±0.5 | 400               | 950                  |
| WXP-683K    | 0.068     | 18.0      | 13.5      | 7.5       | 15.0±0.5 | 400               | 750                  |
| WXP-104K    | 0.100     | 18.0      | 14.5      | 8.5       | 15.0±0.5 | 400               | 624                  |
| WXP-154K    | 0.150     | 26.5      | 15.5      | 7.5       | 22.5±0.5 | 200               | 498                  |
| WXP-224K    | 0.220     | 26.5      | 16.5      | 8.5       | 22.5±0.5 | 200               | 438                  |
| WXP-334K    | 0.330     | 26.5      | 18.5      | 10.5      | 22.5±0.5 | 150               | 330                  |
| WXP-474K    | 0.470     | 31.5      | 20.5      | 11.5      | 27.5±0.7 | 100               | 220                  |
| WXP-684K    | 0.680     | 31.5      | 23.5      | 13.5      | 27.5±0.7 | 100               | 150                  |
| WXP-105K    | 1.000     | 31.5      | 24.5      | 15.0      | 27.5±0.7 | 80                | 140                  |
| WXP-155K    | 1.500     | 41.5      | 28.5      | 16.0      | 37.5±0.7 | 40                | 80                   |
| WXP-225K    | 2.200     | 41.5      | 33.0      | 18.0      | 37.5±0.7 | 40                | 80                   |

dv/dt up to 0.1µF = 500v/µs  
 dv/dt 0.15µF to 0.68µF = 300v/µs  
 dv/dt 1.0µF to 2.2µF = 200v/µs

### WYP Specifications

| Part Number | Cap. (µF) | L ±0.3 mm | H ±0.3 mm | W ±0.3 mm | P mm     | Quantity Per Box  |                      |
|-------------|-----------|-----------|-----------|-----------|----------|-------------------|----------------------|
|             |           |           |           |           |          | Long Lead 30-35mm | Short Lead 4, 5, 6mm |
| WYP-103M    | 0.010     | 18.0      | 10.5      | 5.5       | 15.0±0.5 | 500               | 1300                 |
| WYP-153M    | 0.015     | 18.0      | 12.5      | 6.5       | 15.0±0.5 | 400               | 950                  |
| WYP-223M    | 0.022     | 18.0      | 13.5      | 7.5       | 15.0±0.5 | 400               | 750                  |
| WYP-273M    | 0.027     | 18.0      | 14.5      | 8.5       | 15.0±0.5 | 400               | 650                  |
| WYP-333M    | 0.033     | 18.0      | 17.0      | 8.5       | 15.0±0.5 | 300               | 550                  |
| WYP-473M    | 0.047     | 26.5      | 15.5      | 7.5       | 22.0±0.5 | 200               | 480                  |
| WYP-683M    | 0.068     | 26.5      | 16.5      | 8.5       | 22.0±0.5 | 200               | 400                  |
| WYP-104M    | 0.100     | 26.5      | 18.5      | 10.5      | 22.5±0.5 | 150               | 330                  |

dv/dt up to 0.033µF = 700v/µs  
 dv/dt 0.047µF to 0.1µF = 500v/µs

## WXP, WXPC, WYP Specifications — continued

### WXPC Specifications

| Part Number | Cap. (µF) | L ±0.3 mm | H ±0.3 mm | W ±0.3 mm | P mm     | Quantity Per Box  |                      |
|-------------|-----------|-----------|-----------|-----------|----------|-------------------|----------------------|
|             |           |           |           |           |          | Long Lead 30-35mm | Short Lead 4, 5, 6mm |
| WXPC-103K   | 0.010     | 13.0      | 10.5      | 4.5       | 10.0±0.5 | 1000              | 2200                 |
| WXPC-153K   | 0.015     | 13.0      | 10.5      | 4.5       | 10.0±0.5 | 1000              | 2200                 |
| WXPC-223K   | 0.022     | 13.0      | 10.5      | 5.5       | 10.0±0.5 | 1000              | 1800                 |
| WXPC-333K   | 0.033     | 13.0      | 12.5      | 5.5       | 10.0±0.5 | 800               | 1500                 |
| WXPC-473K   | 0.047     | 13.0      | 13.5      | 5.5       | 10.0±0.5 | 800               | 1400                 |
| WXPC-473K1  | 0.047     | 18.0      | 10.5      | 5.5       | 15.0±0.5 | 500               | 1300                 |
| WXPC-683M   | 0.068     | 18.0      | 10.5      | 5.5       | 15.0±0.5 | 500               | 1300                 |
| WXPC-104K   | 0.100     | 18.0      | 12.5      | 6.5       | 15.0±0.5 | 500               | 950                  |
| WXPC-154K   | 0.150     | 18.0      | 14.5      | 8.5       | 15.0±0.5 | 400               | 650                  |
| WXPC-224K   | 0.22      | 18.0      | 17.0      | 8.5       | 15.0±0.5 | 300               | 550                  |
| WXPC-224K1  | 0.22      | 26.5      | 15.5      | 7.5       | 22.5±0.7 | 200               | 498                  |
| WXPC-274K   | 0.27      | 26.5      | 15.5      | 7.5       | 22.5±0.7 | 200               | 498                  |
| WXPC-334K   | 0.33      | 26.5      | 16.5      | 8.5       | 22.5±0.7 | 200               | 438                  |
| WXPC-474K   | 0.47      | 26.5      | 18.5      | 10.5      | 22.5±0.7 | 150               | 330                  |
| WXPC-684K   | 0.68      | 31.5      | 20.5      | 11.5      | 27.5±0.7 | 100               | 220                  |
| WXPC-105K   | 1.0       | 31.5      | 23.5      | 13.5      | 27.5±0.7 | 100               | 150                  |
| WXPC-155M   | 1.5       | 31.5      | 24.5      | 15.0      | 27.5±0.7 | 80                | 140                  |
|             |           | L ±0.5 mm | H ±0.5 mm | W ±0.5 mm |          |                   |                      |
| WXPC-225K   | 2.2       | 41.5      | 28.5      | 16.0      | 37.5±0.7 | 40                | 80                   |
| WXPC-335K   | 3.3       | 41.5      | 33.0      | 18.0      | 37.5±0.7 | 40                | 80                   |
| WXPC-475K   | 4.7       | 42.0      | 38.0      | 21.0      | 37.5±0.7 | 40                | 45                   |
| WXPC-685M   | 6.8       | 42.0      | 38.0      | 21.0      | 37.5±0.7 | 40                | 45                   |

dv/dt up to 0.1µF = 500v/µs  
dv/dt 0.15µF to 0.68µF = 300v/µs  
dv/dt 1.0µF to 1.5µF = 200v/µs  
dv/dt 2.2µF to 6.8µF = 100v/µs

## WYE Specifications

| Standard Lead Lengths  |                           |  |
|--|---------------------------|--|
| Lead cut suffixes L04, L05 & L06 for 4mm, 5mm, 6mm $\pm$ 1mm lead lengths respectively |                           | Solid uninsulated wire $\phi = 0.8$ mm |
| Standard   | 35mm $\pm$ 5mm long leads | Solid uninsulated wire $\phi = 0.8$ mm |

### Uninsulated Leads

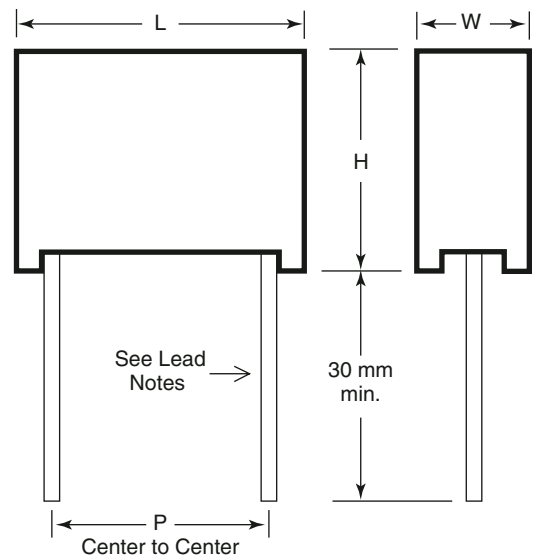

## WYE Specifications

| Part Number | Cap. ( $\mu$ F) | L max mm | H max mm | W max mm | P $\pm 0.5$ mm | Quantity Per Box  |                      |
|-------------|-----------------|----------|----------|----------|----------------|-------------------|----------------------|
|             |                 |          |          |          |                | Long Lead 30-35mm | Short Lead 4, 5, 6mm |
| WYE-102M    | 0.0010          | 13.0     | 10.5     | 4.5      | 10.0           | 1000              | 2200                 |
| WYE-152M    | 0.0015          | 13.0     | 10.5     | 4.5      | 10.0           | 1000              | 2200                 |
| WYE-222M    | 0.0022          | 13.0     | 10.5     | 5.5      | 10.0           | 1000              | 1800                 |
| WYE-252M    | 0.0025          | 13.0     | 10.5     | 5.5      | 10.0           | 1000              | 1800                 |
| WYE-332M    | 0.0033          | 13.0     | 12.5     | 5.5      | 10.0           | 800               | 1500                 |
| WYE-392M    | 0.0039          | 13.0     | 12.5     | 5.5      | 10.0           | 800               | 1500                 |
| WYE-472M    | 0.0047          | 13.0     | 13.5     | 5.5      | 10.0           | 800               | 1400                 |
| WYE-682M    | 0.0068          | 18.0     | 14.0     | 5.5      | 15.0           | 500               | 1000                 |

dv/dt up to 0.0047 $\mu$ F = 1000v/ $\mu$ s  
 dv/dt 0.0068 $\mu$ F to 0.022 $\mu$ F = 600v/ $\mu$ s

## Taping Specifications

### Taping of Capacitors

**The original lead spacing of 10.0 mm (suffix code — T1)**  
 (the pitch of holes on carrier tape = 12.7 mm) (All dimensions in mm)

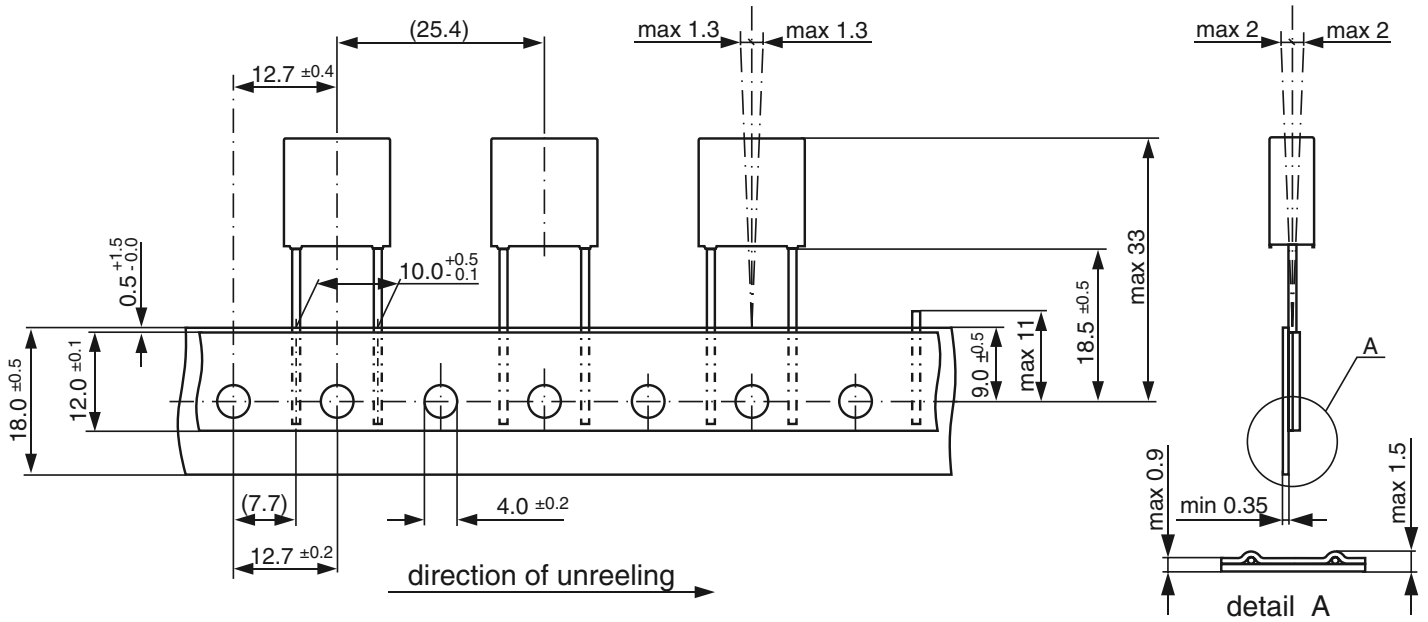

**The original lead spacing of 15.0 mm (suffix code — T2)**  
 (the pitch of holes on carrier tape = 12.7 mm) (All dimensions in mm)

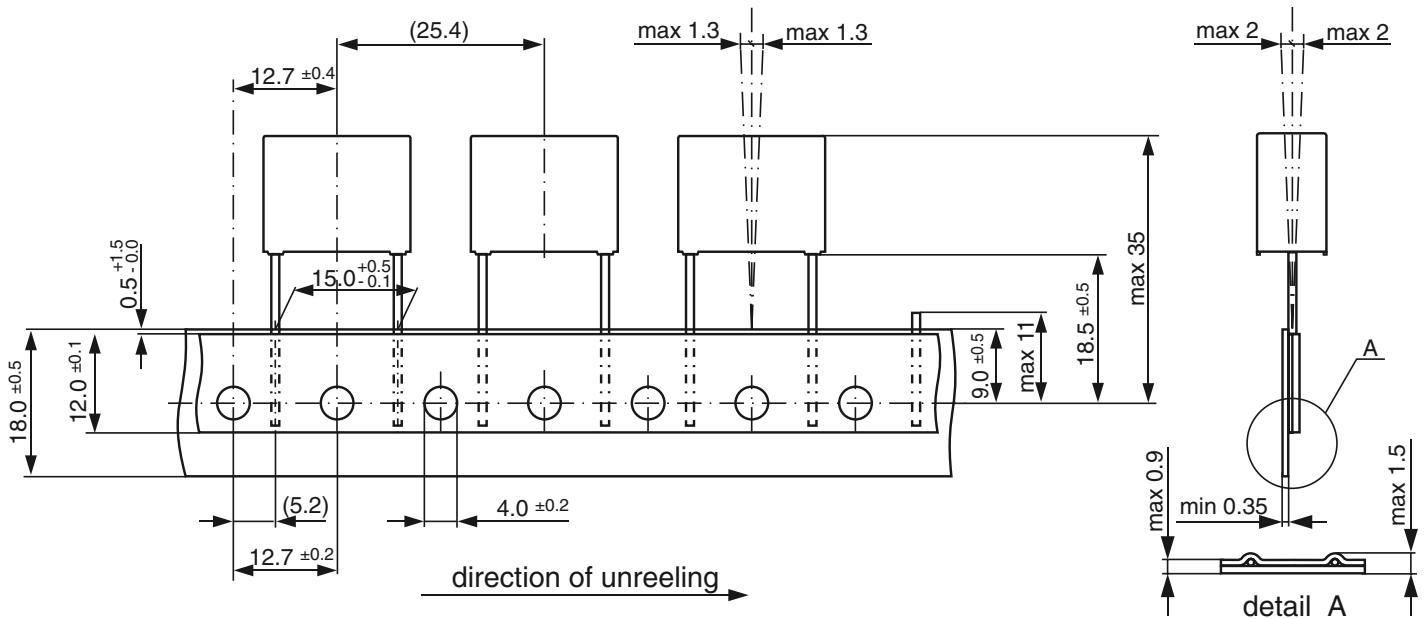

## Taping Specifications — continued

### Taping of Capacitors

The original lead spacing of 10.0 mm crimped to the lead spacing of 7.5 mm (suffix code — T3)  
 (the pitch of holes on carrier tape = 15.0 mm) (All dimensions in mm)

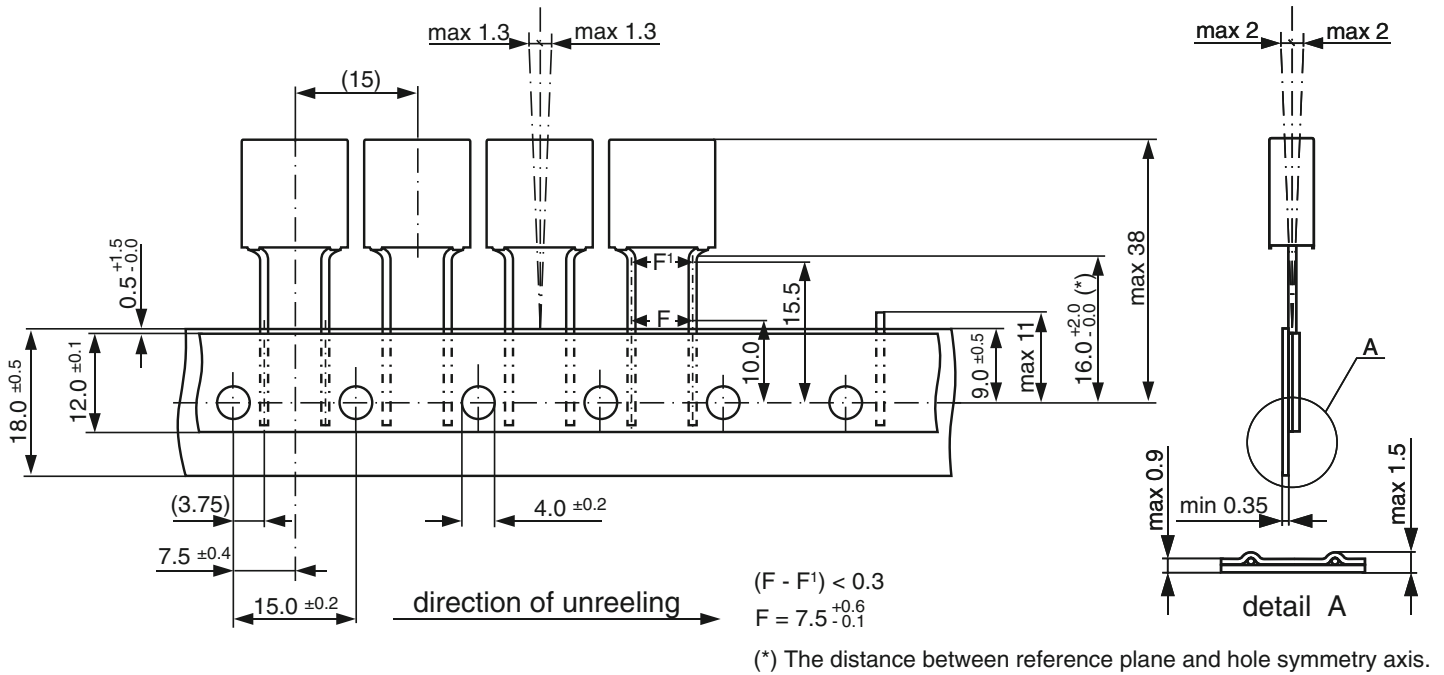

The original lead spacing of 15.0 mm crimped to the lead spacing of 7.5 mm (suffix code — T4)  
 (the pitch of holes on carrier tape = 15.0 mm) (All dimensions in mm)

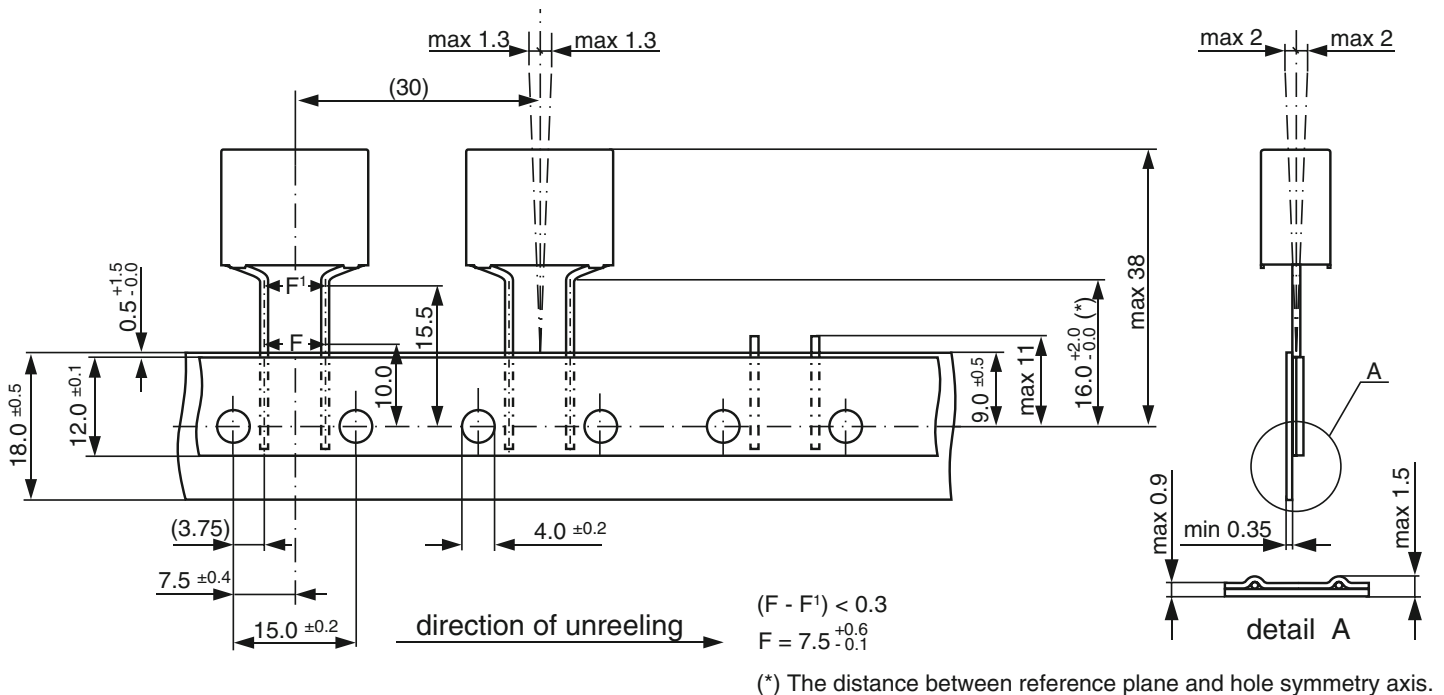

## Taping Specifications — continued

### Packaging of Capacitors

#### AMMO Packing

| Capacitor case dimension<br>(W x H x L) | Lead spacing | Number of taped capacitors per box |
|---|--------------|------------------------------------|
| mm                                      | mm           | pcs                                |
| 4.5 x 10.5 x 13.0                       | 10.0         | 516                                |
| 5.5 x 10.5 x 13.0                       | 10.0         | 420                                |
| 5.5 x 12.5 x 13.0                       | 10.0         | 420                                |
| 5.5 x 13.5 x 13.0                       | 10.0         | 420                                |
| 5.5 x 10.5 x 18.0                       | 15.0         | 420                                |
| 5.5 x 14.0 x 18.0                       | 15.0         | 420                                |
| 6.5 x 12.5 x 18.0                       | 15.0         | 360                                |
| 7.5 x 13.5 x 18.0                       | 15.0         | 312                                |
| 8.5 x 14.5 x 18.0                       | 15.0         | 276                                |
| 8.5 x 17.0 x 18.0                       | 15.0         | 276                                |
| 4.5 x 10.5 x 13.0                       | 10.0 / 7.5   | 860                                |
| 5.5 x 10.5 x 13.0                       | 10.0 / 7.5   | 700                                |
| 5.5 x 12.5 x 13.0                       | 10.0 / 7.5   | 700                                |
| 5.5 x 13.5 x 13.0                       | 10.0 / 7.5   | 700                                |
| 5.5 x 10.5 x 18.0                       | 15.0 / 7.5   | 350                                |
| 5.5 x 14.0 x 18.0                       | 15.0 / 7.5   | 350                                |
| 6.5 x 12.5 x 18.0                       | 15.0 / 7.5   | 300                                |
| 7.5 x 13.5 x 18.0                       | 15.0 / 7.5   | 260                                |
| 8.5 x 14.5 x 18.0                       | 15.0 / 7.5   | 230                                |
| 8.5 x 17.0 x 18.0                       | 15.0 / 7.5   | 230                                |

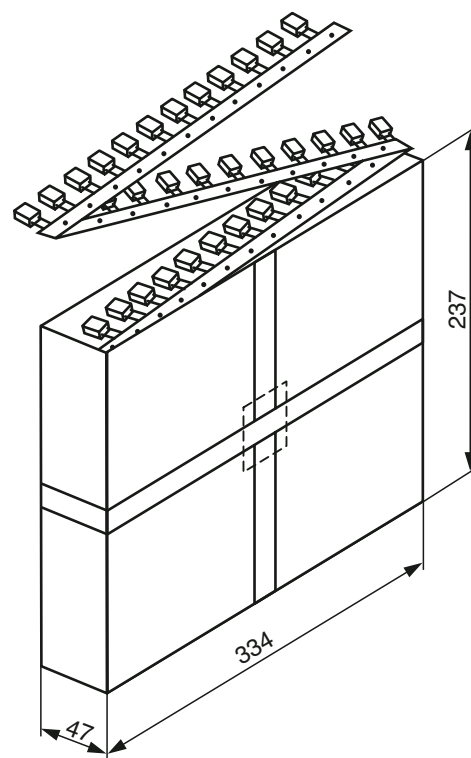

#### Requirements

1. A maximum of 2 consecutive capacitors may be missing provided this gap is followed by 6 consecutive capacitors.
2. The maximum number of empty places per reel shall not exceed 0.5% of the total number of the capacitors per reel.
3. Cummulative pitch error over 20 pitches:  $\pm 1.0$  mm.
4. The other taping requirements: acc. to EN/IEC 60286-2 & EIA-468-B.

## Marking and Safety Approvals

### Marking

- World Products Inc. Logo
- Part Number & Film Symbol (MKP or MKT)
- Capacitance
- Rated Voltage
- Climatic Category
- Class (X2 or Y2)
- Safety Approval Marking
- EIA Date Code (YYWW) Year & Week #

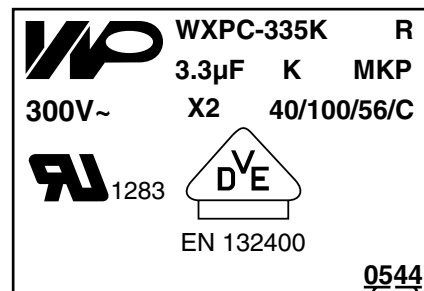

Year Week

### Safety Approval References

| Symbol      | Country | Reference   | WYE File | WXP File   | WXPC File | WYP File |
|-------------|---------|-------------|----------|------------|-----------|----------|
| UL          | USA     | UL 1283     | E119899  | E119899    | E119899   | E119899  |
| UL and C-UL | USA     | **UL 1414   | E71602   | E71602     | E71602    | E71602   |
| CSA         | Canada  | **22.2 No.1 | LR86091  | LR86091    |           |          |
| CSA         | Canada  | E384-14-95  |          | ***LR86091 |           |          |
| VDE         | Germany | *           | 87425    | 94633      | 94633     | 132747   |

\* Approval test standards: EN132400, 1994/IEC 384-14, 2nd Edition, 1993

\*\* UL1414, C-UL, and CSA 22.2 No. 1 approvals apply only up to 1μF.

\*\*\* For WXP capacitance values 1.5uF and 2.2uF only.

**NOTE:** Approvals only apply to solid uninsulated leads (standard lead type).

DISCLAIMER: The names of the products and the specifications in this catalog are subject to change without notice for the sake of improvement. World Products Inc. also reserves the right to discontinue any of these products. The products in this catalog are intended for use in ordinary electronic products. If any of these products are to be used in special applications requiring extremely high reliability, where product defects might pose a safety risk, please consult World Products Inc. Though World Products Inc. has taken all possible precautions to ensure the quality and reliability of its products, improper use of products may result in bodily injury, fire, or similar accident. If you have any questions regarding the use of the products in question, please consult World Products Inc. Please be advised that World Products Inc. accepts no responsibility for any infraction by users of World Products Inc. products on third party patents or industrial copyrights.

# RFI SUPPRESSORS