



TAOGLAS®



Datasheet

4dBi 2.4GHz Omni-Directional Heavy Duty Screw Mount Antenna

Part No:
WS.02.B.205111

Features:

Wi-Fi/ISM Bands/ZigBee/WLAN/ Bluetooth
UV and Vandal Resistant ABS Housing
Cable length and connector customizable
2M CFD-200 SMA(M) – Standard
IP65 Rated Enclosure
RoHS Compliant

1. Introduction	3
2. Specifications	4
3. Antenna Characteristics	5
4. Radiation Patterns	7
5. Mechanical Drawing	14
6. Installation Guide	15
7. Packaging	16
<hr/>	
Changelog	17

Taoglas makes no warranties based on the accuracy or completeness of the contents of this document and reserves the right to make changes to specifications and product descriptions at any time without notice. Taoglas reserves all rights to this document and the information contained herein. Reproduction, use or disclosure to third parties without express permission is strictly prohibited.



1. Introduction



WS.02 Hercules is a high efficiency, high gain thread mount 2.4GHz wireless antenna for external use on vehicles and outdoor assets worldwide. Omni-directional gain across the frequency bands ensures constant reception and transmission making the WS.02 an ideal solution for a Zigbee Wireless Mesh for remote applications e.g. – remote metering.

It has been designed for heavy duty work with extra thick threads; with durable UV-resistant IP65 rated PC housing, it is resistant to vandalism and direct attack. At only 29 mm high it complies with the latest EU height restrictions directives for roof-mounted objects, whilst also enabling covert operation with a diameter of 49mm.

Many module manufacturers specify peak gain limits for any antennas that are to be connected to that module. Those peak gain limits are based on free-space conditions. In practice, the peak gain of an antenna tested in free-space can degrade by at least 1 or 2dBi when put inside a device. So ideally you should go for a slightly higher peak gain antenna than mentioned on the module specification to compensate for this effect, giving you better performance.

Upon testing of any of our antennas with your device and a selection of appropriate layout, integration technique, or cable, Taoglas can make sure any of our antennas' peak gain will be below the peak gain limits. Taoglas can then issue a specification and/or report for the selected antenna in your device that will clearly show it complying with the peak gain limits, so you can be assured you are meeting regulatory requirements for that module.

For example, a module manufacturer may state that the antenna must have less than 2dBi peak gain, but you don't need to select an embedded antenna that has a peak gain of less than 2dBi in free-space. This will give you a less optimized solution. It is better to go for a slightly higher free-space peak gain of 3dBi or more if available. Once that antenna gets integrated into your device, performance will degrade below this 2dBi peak gain due to the effects of GND plane, surrounding components, and device housing. If you want to be absolutely sure, contact Taoglas and we will test. Choosing a Taoglas antenna with a higher peak gain than what is specified by the module manufacturer and enlisting our help will ensure you are getting the best performance possible without exceeding the peak gain limits.

2. Specifications

Wi-Fi MIMO			
Frequency (MHz)	2400	2450	2500
Efficiency (%)			
Freespace	62	58	57
30x30cm Groundplane	65	58	57
Average Gain (dB)			
Freespace	-2.1	-2.4	-2.5
30x30cm Groundplane	-1.9	-2.4	-2.4
Peak Gain (dBi)			
Freespace	6.7	6.5	6.8
30x30cm Groundplane	3.7	3.3	2.6
Impedance	50Ω		
Polarization	Linear		
Radiation Pattern	Omni-directional		

Mechanical	
Dimensions	Height 28.5mm x Diameter 47.8mm
Casing	UV resistant PC
Base and thread	Nickel plated Steel/Zinc
Thread diameter	18mm
Weather proof gasket	CR4305 foam with 3M9448B double-side adhesive
Antenna Weight	130g
Environmental	
Corrosion	5% NaCl for 48hrs - Nickel plated steel base and thread
Temperature Range	-40°C to +85°C
Thermal Shock	100 cycles -40°C to +80°C
Humidity	Non-condensing 65°C 95% RH
Shock (drop test)	1m drop on concrete 6 axes
Cable pull	8 KGf
Ingress Protection	IP65

3. Antenna Characteristics

3.1 Return Loss

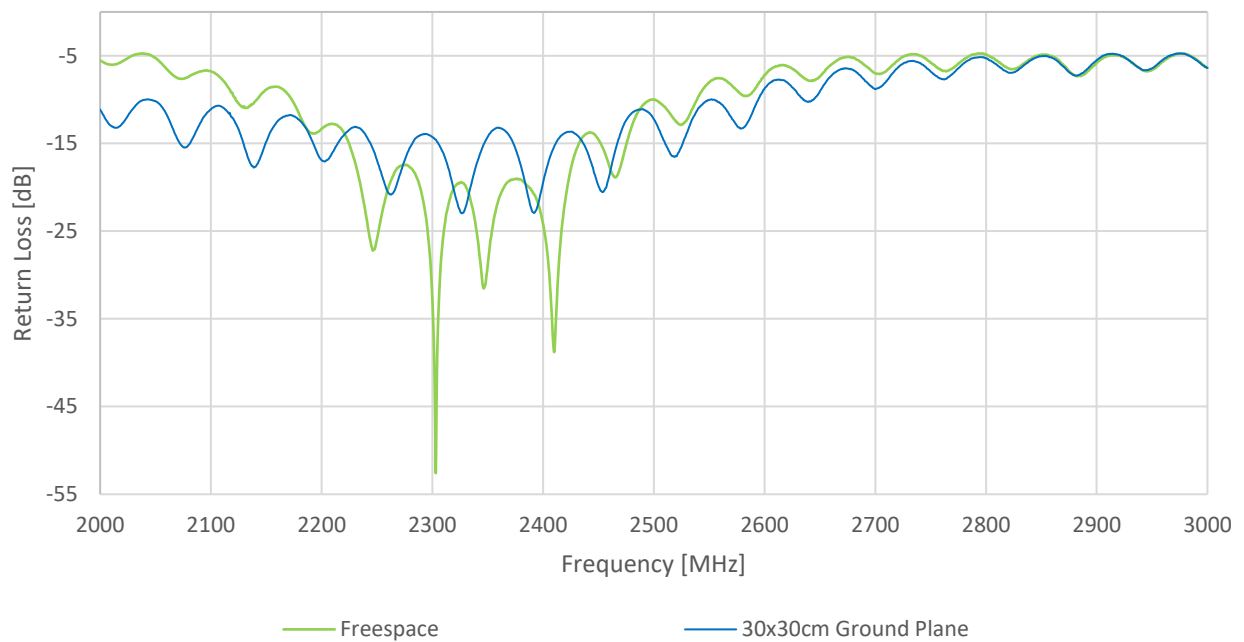

3.2 Efficiency

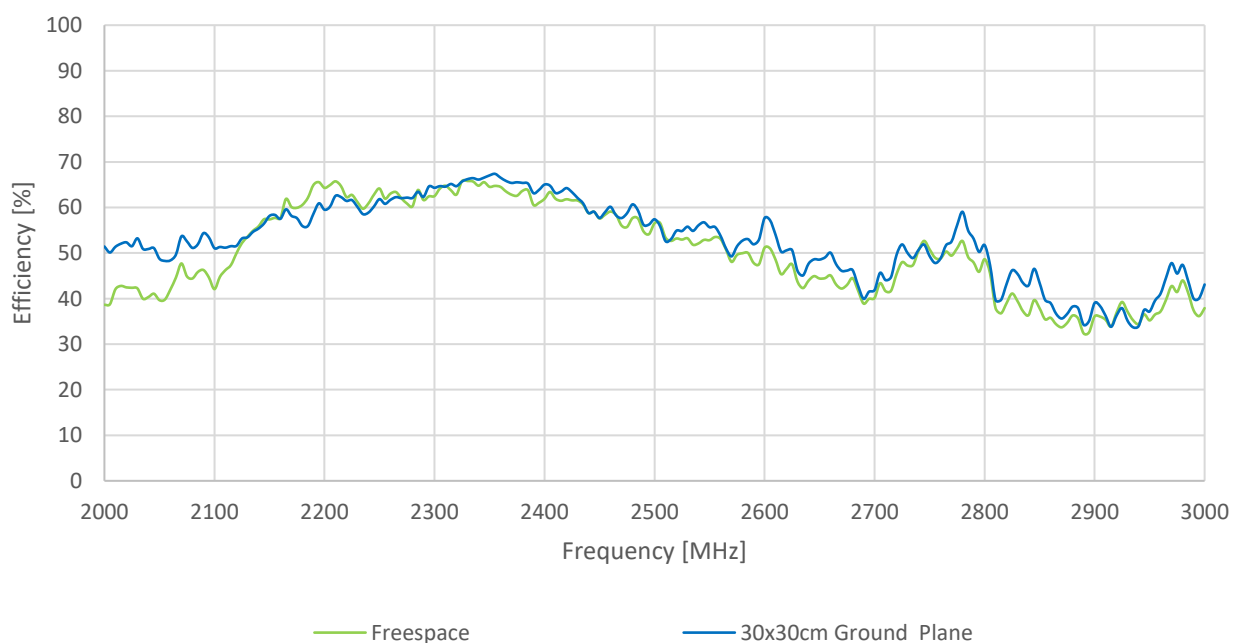

3.3 Average Gain

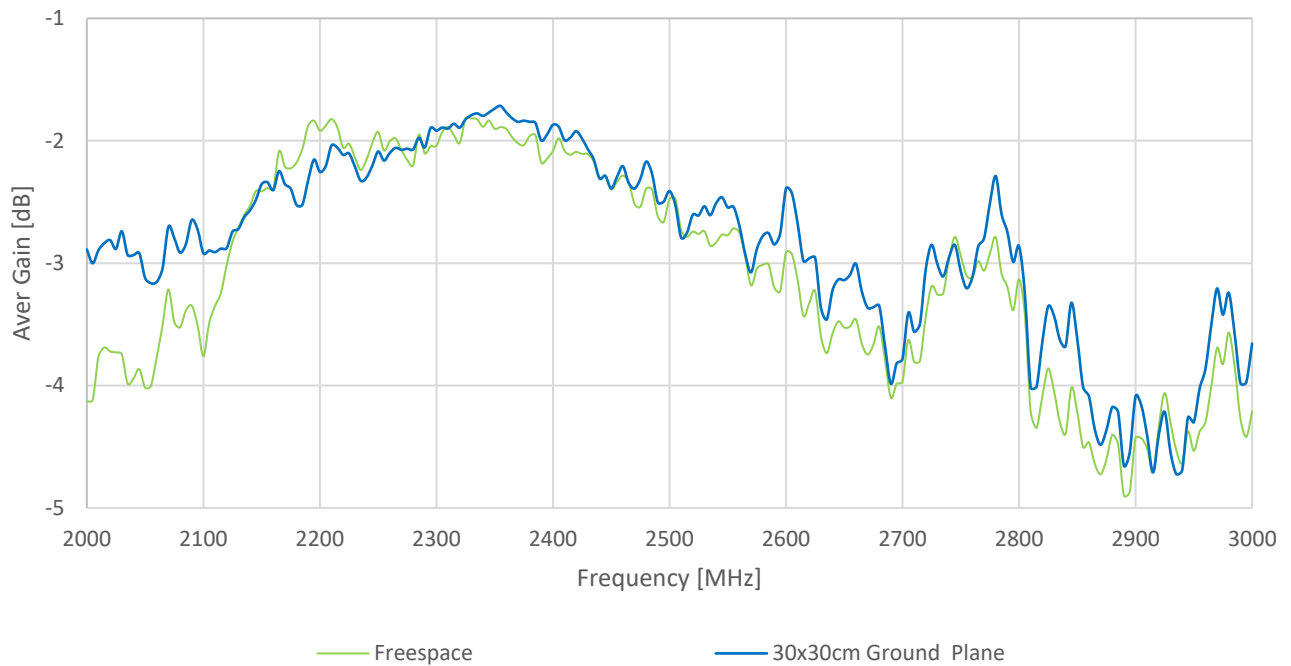

3.4 Peak Gain

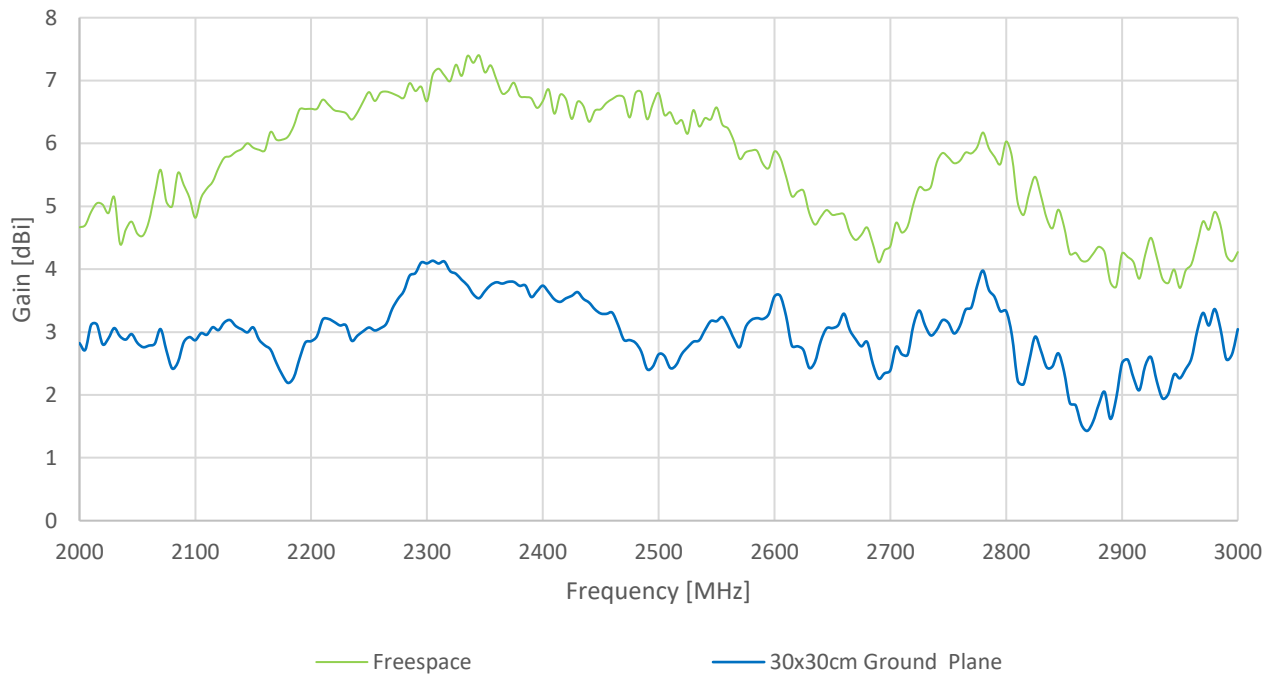

4. Radiation Patterns

4.1 Test Setups

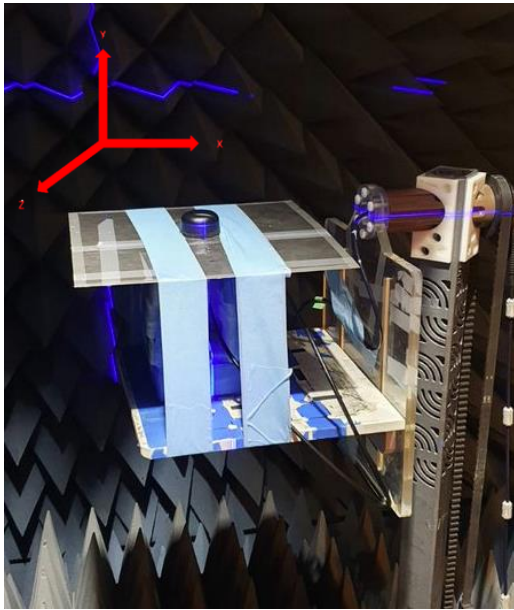

Chamber setup on 30x30cm groundplane

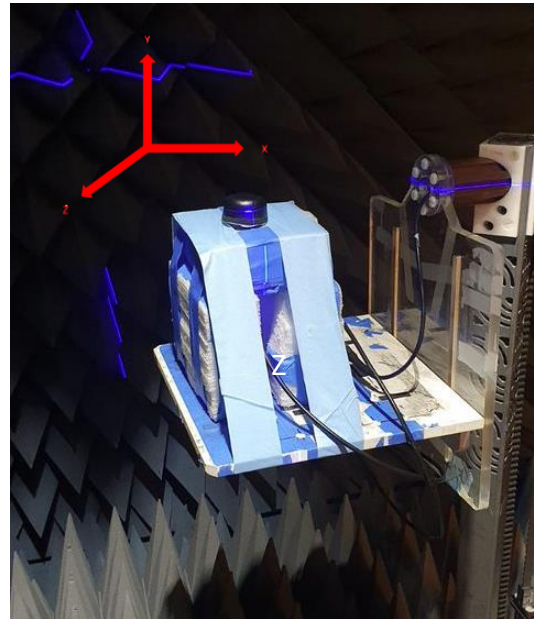

Chamber setup in freespace

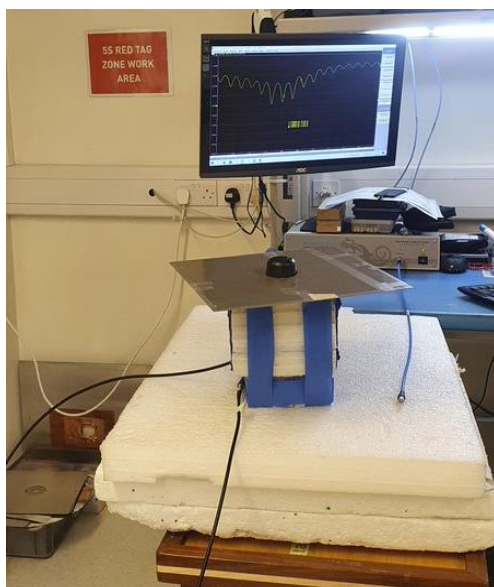

VNA setup on 30x30cm groundplane

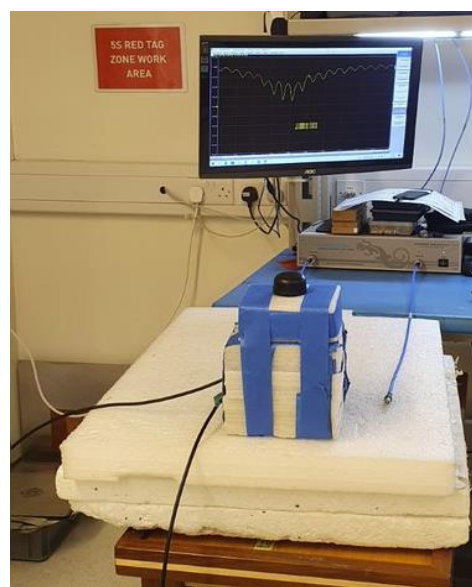

VNA setup in freespace

4.2 2400MHz_Freespace 2D & 3D Radiation Patterns

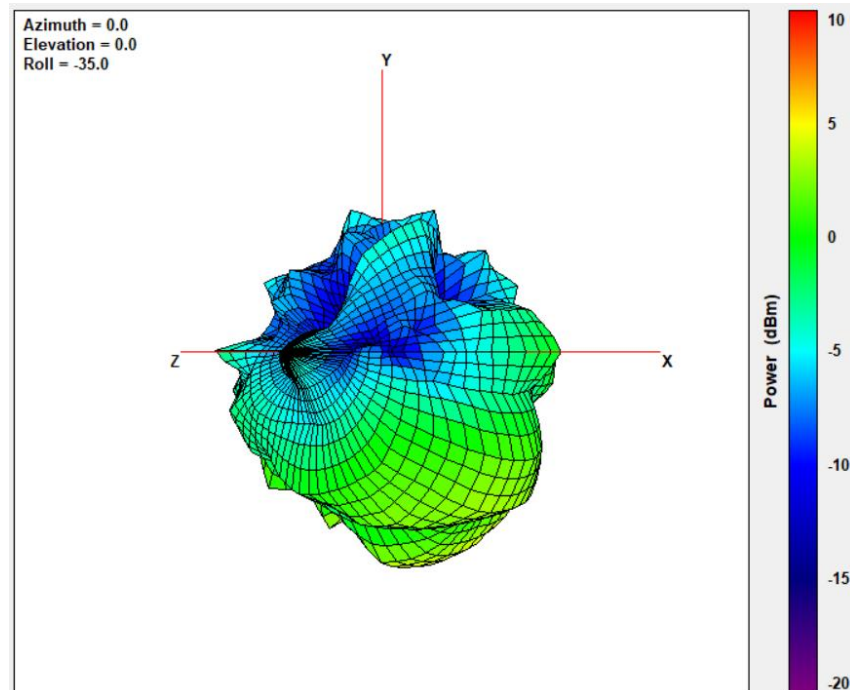

XY Plane

XZ Plane

YZ Plane

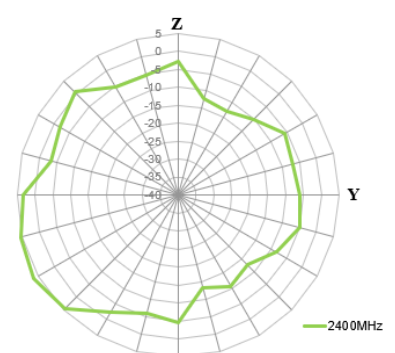
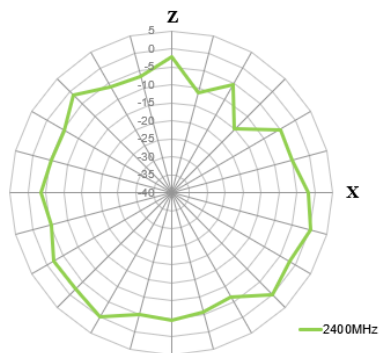
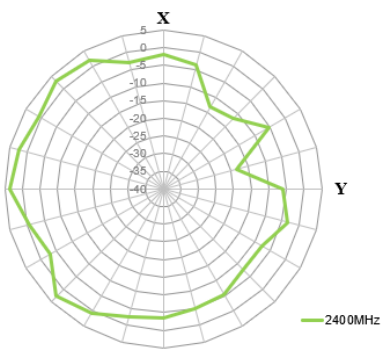

2500MHz

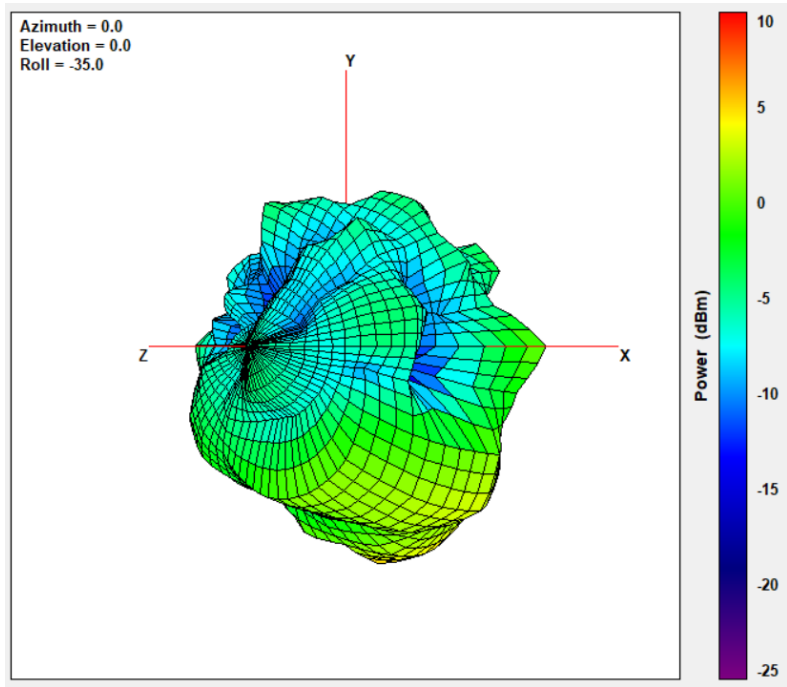

XY Plane

XZ Plane

YZ Plane

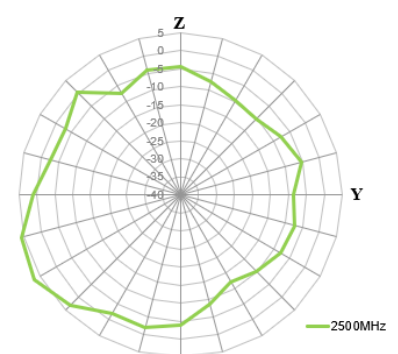
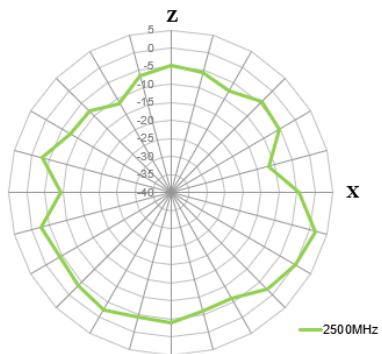
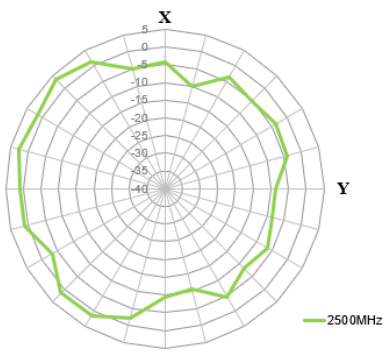

4.3 2400MHz_30x30cm Groundplane 2D & 3D Radiation Patterns

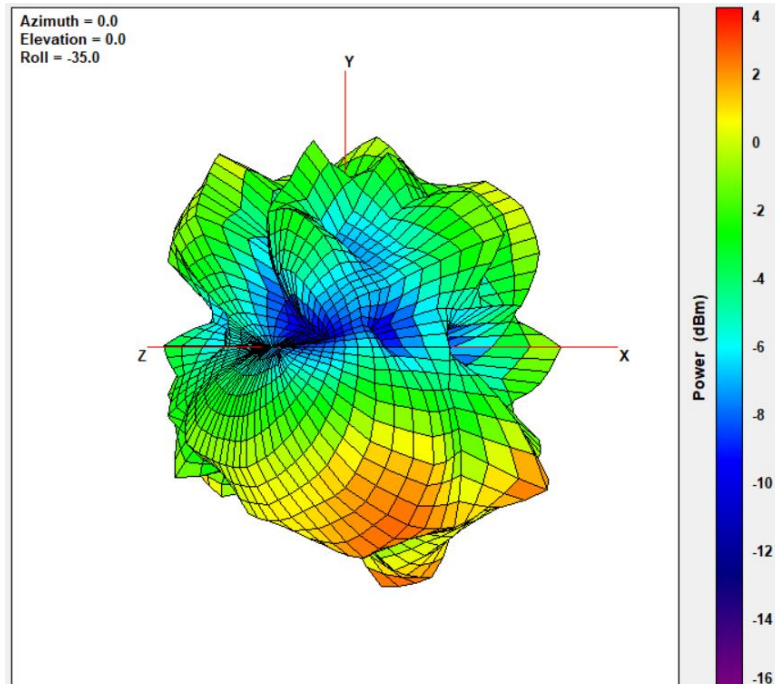

XY Plane

XZ Plane

YZ Plane

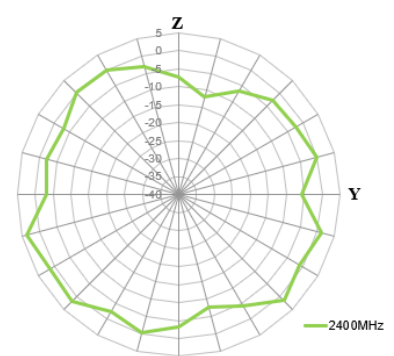
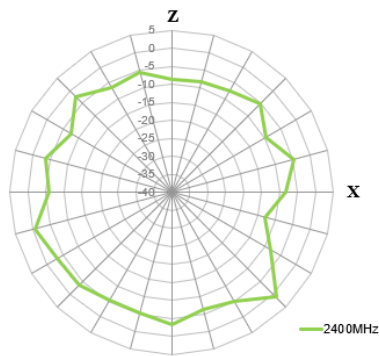
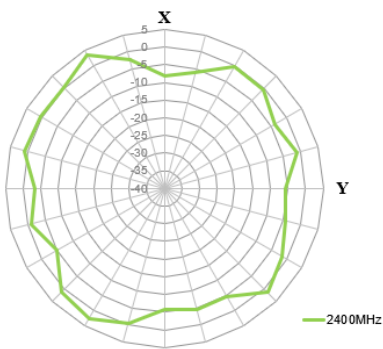

2450MHz

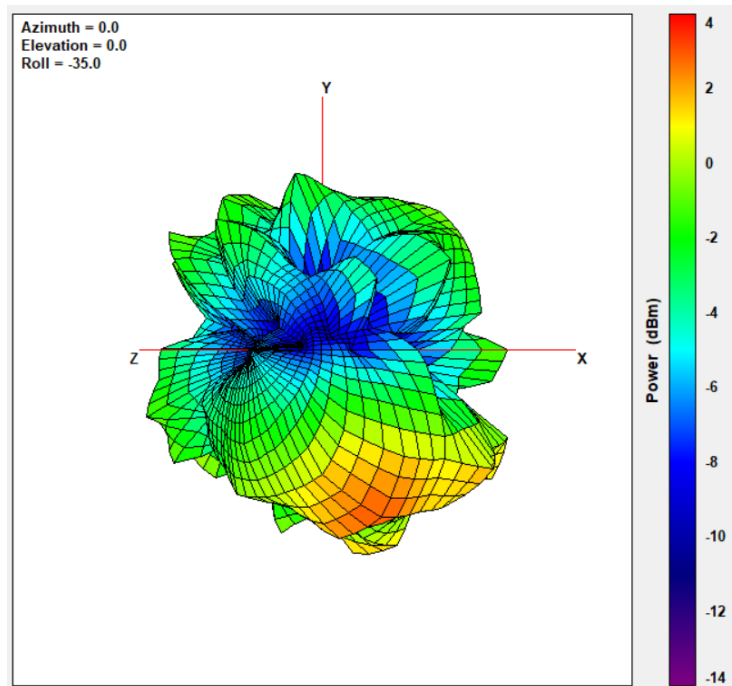

XY Plane

XZ Plane

YZ Plane

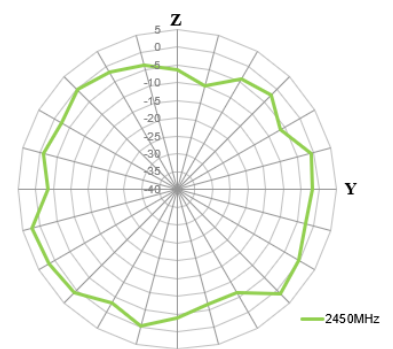
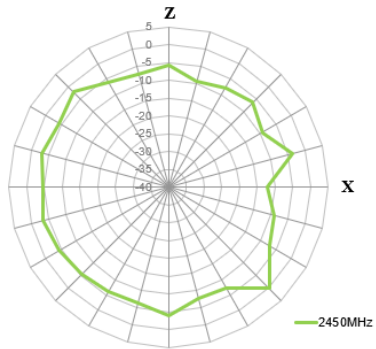
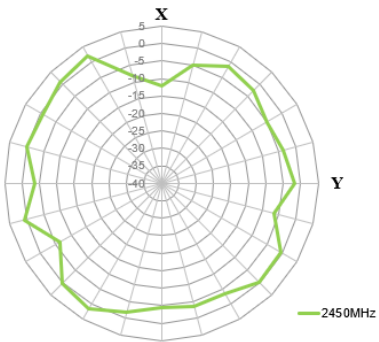

2500MHz

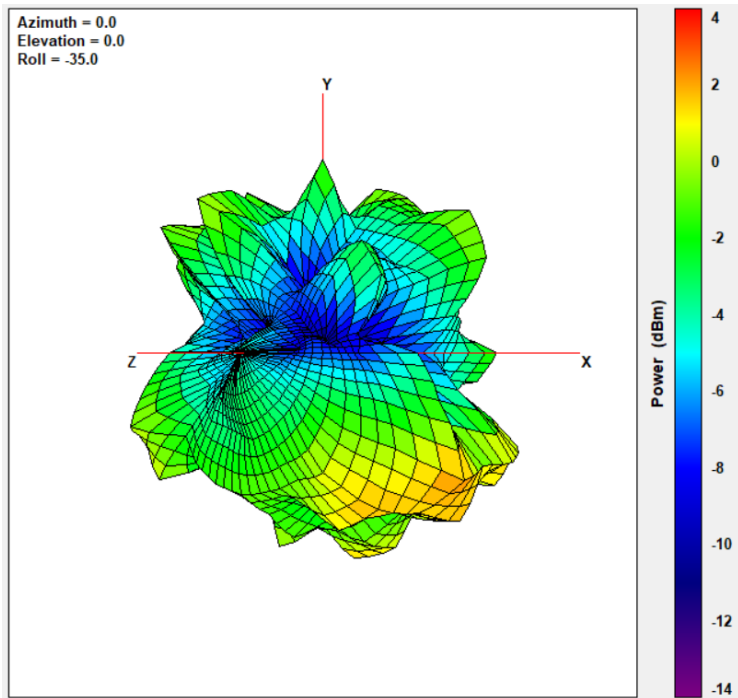

XY Plane

XZ Plane

YZ Plane

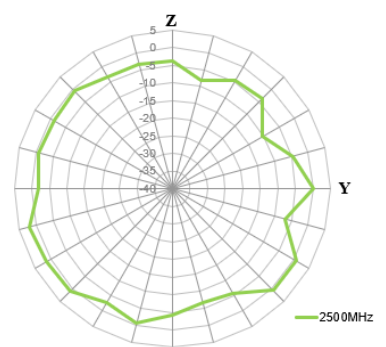
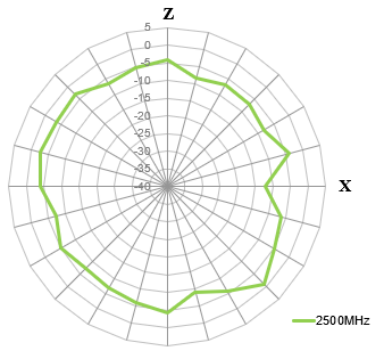
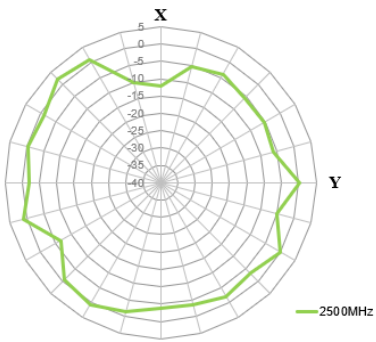

5. Mechanical Drawing (Units: mm)

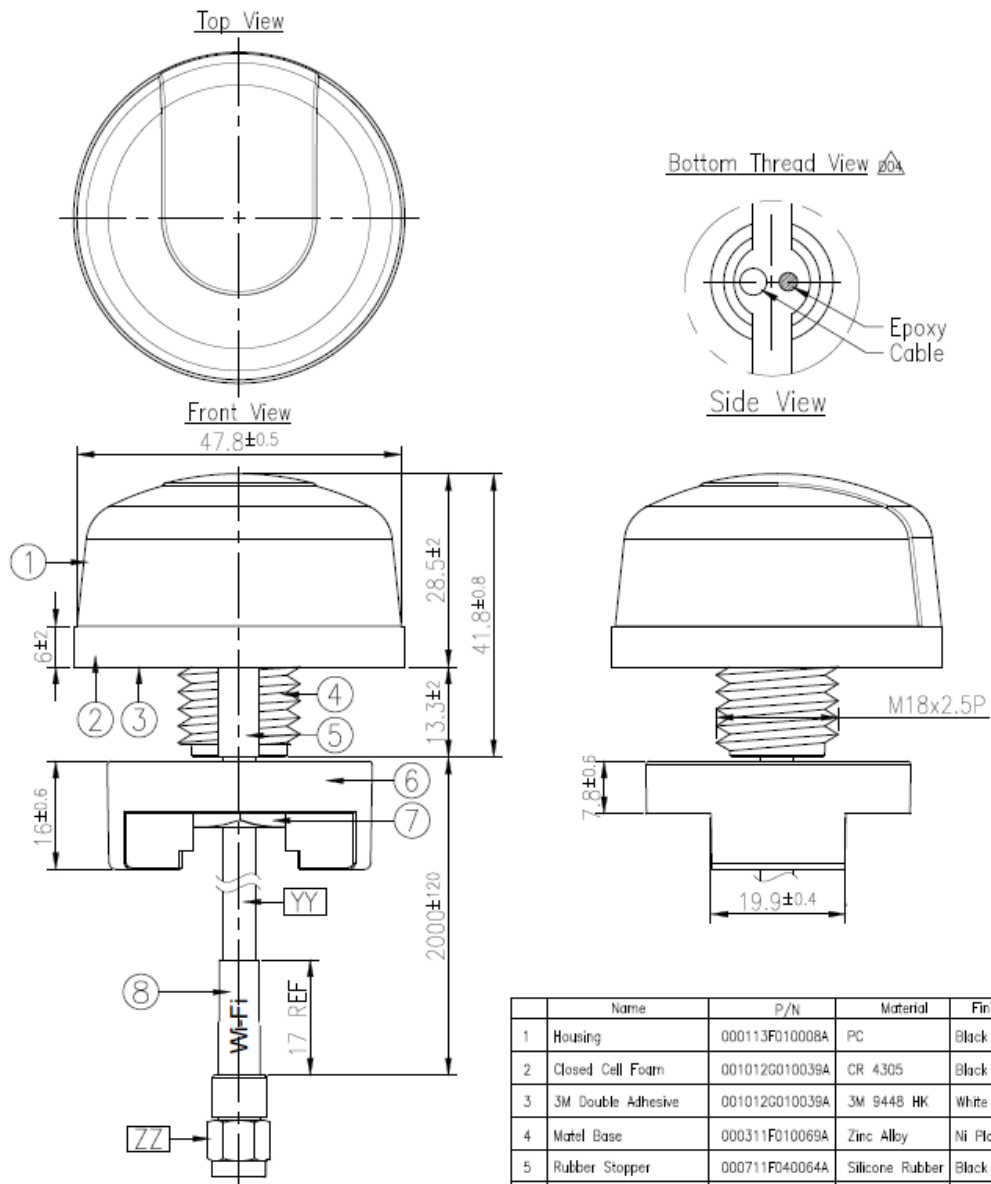

Notes:

1. The connector position has special orientation to the PCB as per drawing.
2. All Material Must Be RoHS Compliant.
3. Open/short QC, VSWR required.

	Name	P/N	Material	Finish	QTY
1	Housing	000113F010008A	PC	Black	1
2	Closed Cell Foam	001012G010039A	CR 4305	Black	1
3	3M Double Adhesive	001012G010039A	3M 9448 HK	White Liner	1
4	Metel Base	000311F010069A	Zinc Alloy	Ni Plated	1
5	Rubber Stopper	000711F040064A	Silicone Rubber	Black	1
6	Outer Nut Cover	000111F020008A	ASA	Black	1
7	M18 Inner Nut Cut	000413F010061A	Steel Carbon	Zn Plated	1
8	Heat Shrink Tube(Wi-Fi)	001316L050000A	PE	Yellow Tube/Black Text	1
	Name	P/N	Spec	Finish	QTY
YY	Cable Type	301415C010000A	CFD-200	Black	1
ZZ	Connector Type	200212G020002A	SMA(M)ST	Au Plated	1

6. Installation

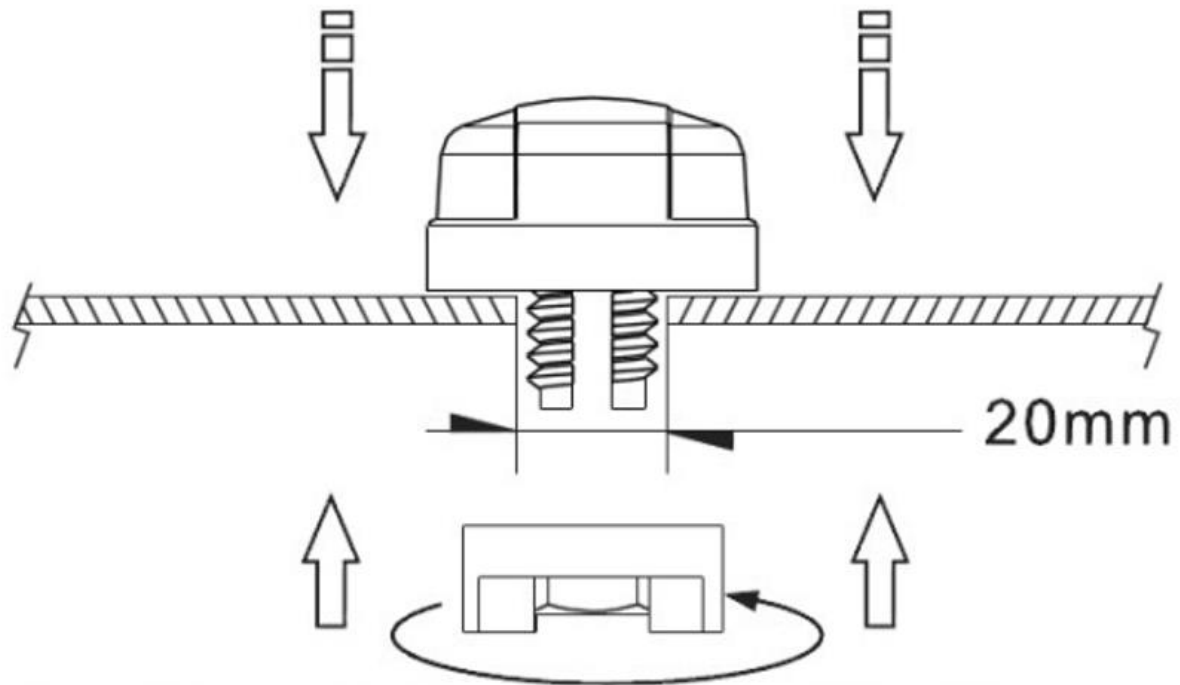

Hand Tighten Only

7. Packaging

1pc WS.02.B.205111 per PE Bag
 Weight - 130g

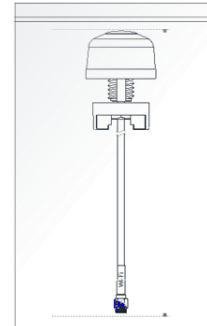

50pcs WS.02.B.205111 per carton
 Dimensions - 390*330*260mm
 Weight - 6.75Kg

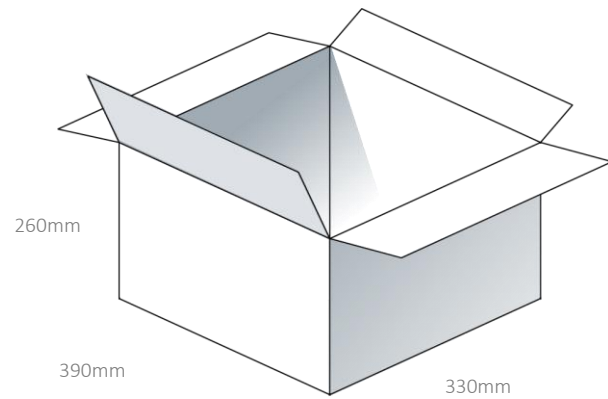

Changelog for the datasheet

SPE-14-8-055- WS.02.B.205111

Revision: F (Current Version)

Date:	2022-06-01
Changes:	Full datasheet template update
Changes Made by:	Gary West

Previous Revisions

Revision: E

Date:	2021-11-21
Changes:	Added IP rating
Changes Made by:	Erik Landi

Revision: A (Original First Release)

Date:	2014-05-28
Notes:	
Author:	Technical Writer

Revision: D

Date:	Unknown
Changes:	
Changes Made by:	Technical Writer

Revision: C

Date:	Unknown
Changes:	
Changes Made by:	Technical Writer

Revision: B

Date:	Unknown
Changes:	
Changes Made by:	Technical Writer



TAOGLAS®

www.taoglas.com

