

WP76761CSEC/E

HYPER ORANGE

### Features

- SUPER FLUX OUTPUT.
- DESIGN FOR HIGH CURRENT OPERATION.
- OUTSTANDING MATERIAL EFFICIENCY.
- RELIABLE AND RUGGED.
- RoHS COMPLIANT.

### Description

The Hyper Orange source color devices are made with DH InGaAlP on GaAs substrate Light Emitting Diode.

### Package Dimensions

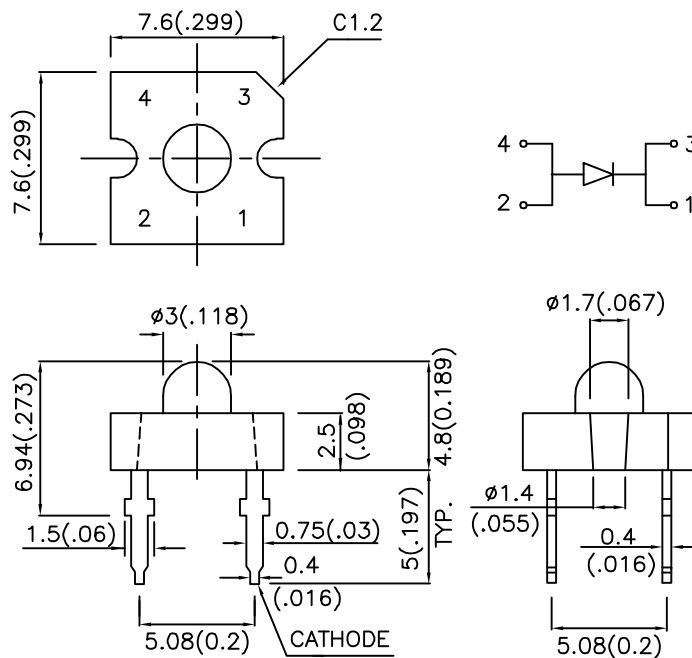

#### Notes:

1. All dimensions are in millimeters (inches).
2. Tolerance is  $\pm 0.25(0.01)$ " unless otherwise noted.
3. Lead spacing is measured where the leads emerge from the package.
4. Specifications are subject to change without notice.

## Selection Guide

Part No.	Dice	Lens Type	Iv (mcd) @ 20mA*70mA		Viewing Angle
			Min.	Typ.	2θ1/2
WP76761CSEC/E	HYPER ORANGE(InGaAlP)	WATER CLEAR	1800	3400	20°
			*5700	*10000	

Notes:

1. θ1/2 is the angle from optical centerline where the luminous intensity is 1/2 the optical centerline value.
2. \* Luminous intensity with asterisk is measured at 70mA under 40ms pulse width.
3. Drive current between 10mA and 30mA are recommended for long term performance.
4. Operation at current below 10mA is not recommended.

## Electrical / Optical Characteristics at TA=25°C

Symbol	Parameter	Device	Typ.	Max.	Units	Test Conditions
λ <sub>peak</sub>	Peak Wavelength	Hyper Orange	630		nm	I <sub>F</sub> =20mA
λ <sub>D</sub>	Dominant Wavelength	Hyper Orange	621		nm	I <sub>F</sub> =20mA
Δλ <sub>1/2</sub>	Spectral Line Half-width	Hyper Orange	20		nm	I <sub>F</sub> =20mA
C	Capacitance	Hyper Orange	25		pF	V <sub>F</sub> =0V;f=1MHz
V <sub>F</sub>	Forward Voltage	Hyper Orange	2.0	2.5	V	I <sub>F</sub> =20mA
I <sub>R</sub>	Reverse Current	Hyper Orange		10	uA	V <sub>R</sub> = 5V

## Absolute Maximum Ratings at TA=25°C

Parameter	Hyper Orange	Units
Power dissipation	150	mW
DC Forward Current	30	mA
Peak Forward Current [1]	195	mA
Reverse Voltage	5	V
Operating/Storage Temperature	-40°C To +85°C	
Lead Solder Temperature [2]	260°C For 3 Seconds	
Lead Solder Temperature [3]	260°C For 5 Seconds	

Notes:

1. 1/10 Duty Cycle, 0.1ms Pulse Width.
2. 2mm below package base.
3. 5mm below package base.

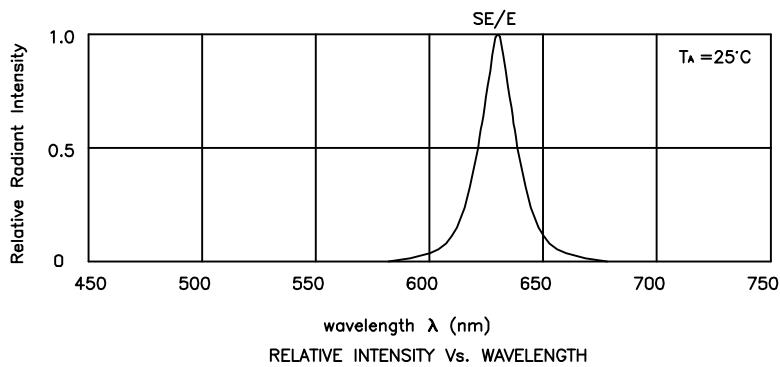

## Hyper Orange

### WP76761CSEC/E

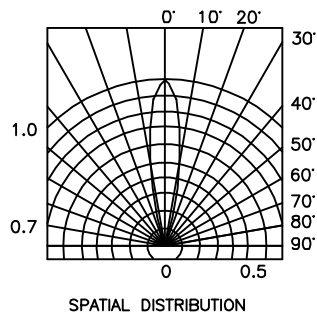
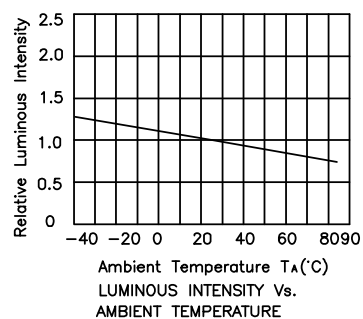
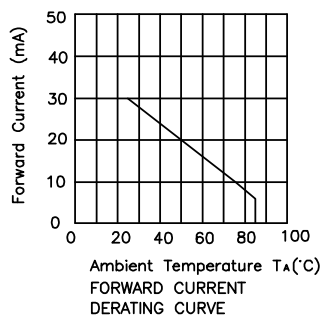
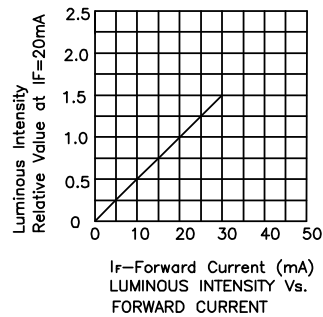
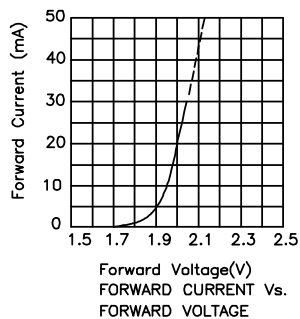

#### Remarks:

If special sorting is required (e.g. binning based on forward voltage, luminous intensity, or wavelength), the typical accuracy of the sorting process is as follows:

1. Wavelength:  $\pm 1\text{nm}$
2. Luminous Intensity:  $\pm 15\%$
3. Forward Voltage:  $\pm 0.1\text{V}$

Note: Accuracy may depend on the sorting parameters.