

Part Number: WP7113SURCK-AMT

Hyper Red

Features

- High reliability LED package.
- Low power consumption.
- Popular T-1 3/4 diameter package.
- General purpose leads.
- Reliable and rugged.
- Long life - solid state reliability.
- Available on tape and reel.
- RoHS compliant.

Description

The Hyper Red source color devices are made with Al-GaInP on GaAs substrate Light Emitting Diode.

Applications

- Traffic signaling.
- Backlighting (illuminated advertising , general lighting).
- Interior and exterior automotive lighting.
- Substitution of micro incandescent lamps.
- Reading lamps.
- Signal and symbol luminaire for orientation.
- Marker lights (e.g. Steps, exit ways, etc).
- Decorative and entertainment lighting.
- Indoor and outdoor commercial and residential architectural lighting.

Package Dimensions

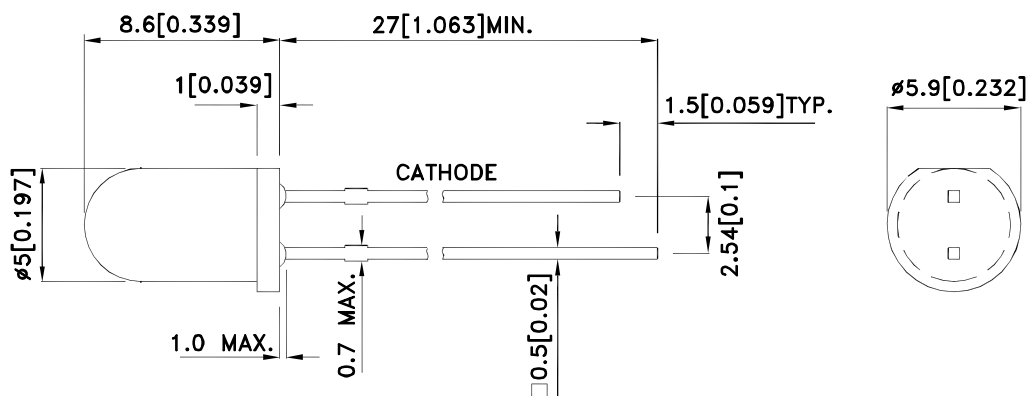

Notes:

1. All dimensions are in millimeters (inches).
2. Tolerance is $\pm 0.25(0.01)$ " unless otherwise noted.
3. Lead spacing is measured where the leads emerge from the package.
4. The specifications, characteristics and technical data described in the datasheet are subject to change without prior notice.



Selection Guide

Part No.	Dice	Lens Type	Iv (mcd) [2] @ 20mA			Viewing Angle [1]
			Code.	Min.	Max.	2θ1/2
WP7113SURCK-AMT	Hyper Red (AlGaInP)	WATER CLEAR	ZB	3600	4200	20°
			ZC	4200	5000	
			ZD	5000	6000	
			ZE	6000	7000	
			ZF	7000	8000	

Notes:

1. θ1/2 is the angle from optical centerline where the luminous intensity is 1/2 of the optical peak value.
2. Luminous intensity/ luminous Flux: +/-15%.

Absolute Maximum Ratings at Ta=25°C

Parameter	Symbol	Value	Unit
Power dissipation	P _D	125	mW
Reverse Voltage	V _R	5	V
Junction temperature	T _J	120	°C
Operating Temperature	Top	-40 To +100	°C
Storage Temperature	T _{stg}	-40 To +120	°C
DC Forward Current[1]	I _F	50	mA
Peak Forward Current [2]	I _{FM}	185	mA
Electrostatic Discharge Threshold (HBM)		3000	V
Thermal Resistance (Junction/ambient) [1]	R _{th(j-a)}	350	°C/W
Lead Solder Temperature [3]		260°C For 3 Seconds	
Lead Solder Temperature [4]		260°C For 5 Seconds	

Notes:

1. R_{th(j-a)} Results from mounting on PC board FR4 (pad size ≥ 16 mm² per pad),
2. 1/10 Duty Cycle, 0.1ms Pulse Width.
3. 2mm below package base.
4. 5mm below package base.

Electrical / Optical Characteristics at Ta=25°C

Parameter	Symbol	Value			Unit
		Min.	Typ.	Max.	
Wavelength at peak emission IF=20mA	λ peak		650		nm
Dominant Wavelength IF=20mA	λ dom [1]	620		640	nm
Spectral bandwidth at 50% Φ REL MAX IF=20mA	$\Delta\lambda$		28		nm
Forward Voltage IF=20mA	V _F [2]	1.6	1.95	2.5	V
Reverse Current (V _R = 5V)	I _R			10	uA
Temperature coefficient of λ peak IF=20mA, -10 ° C ≤ T ≤ 100 ° C	TC λ peak		0.14		nm/° C
Temperature coefficient of λ dom IF=20mA, -10 ° C ≤ T ≤ 100 ° C	TC λ dom		0.05		nm/° C
Temperature coefficient of V _F IF=20mA, -10 ° C ≤ T ≤ 100 ° C	TC _v		-1.8		mV/° C

Notes:

- 1.The dominant Wavelength (λ d) above is the setup value of the sorting machine. (Tolerance λ d : ±1nm.)
2. Forward Voltage: +/-0.1V.

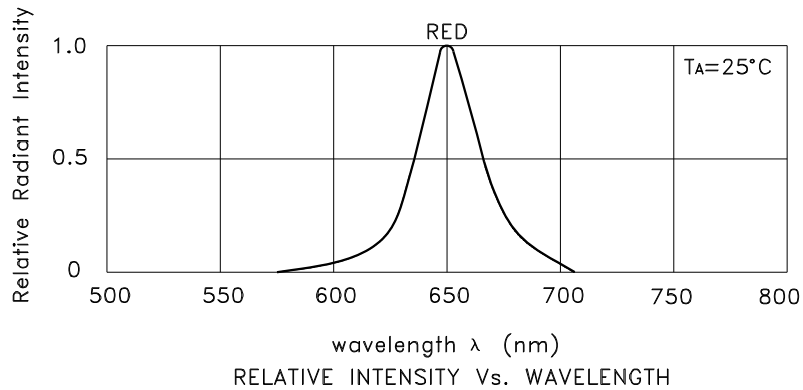

Hyper Red

WP7113SURCK-AMT

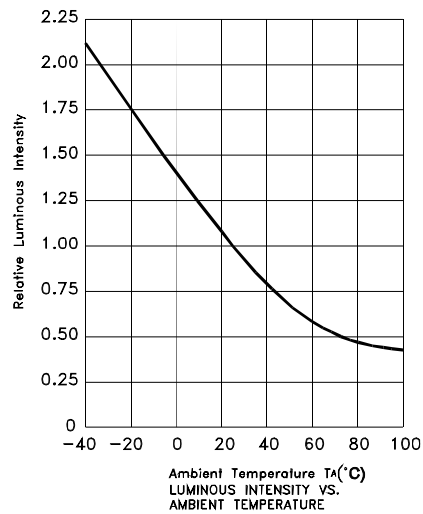
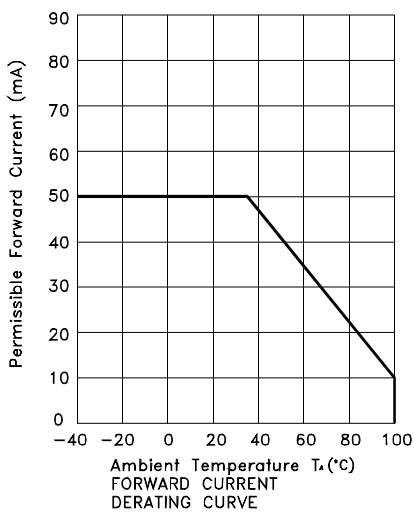
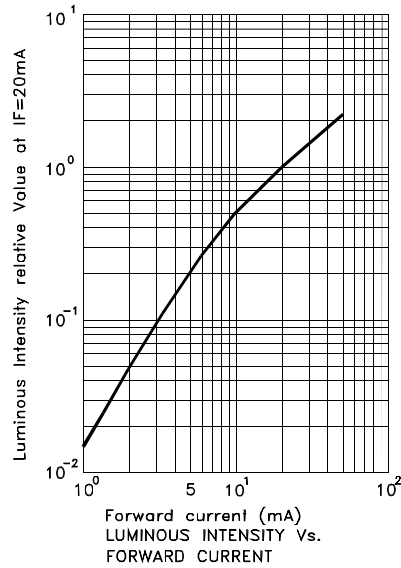
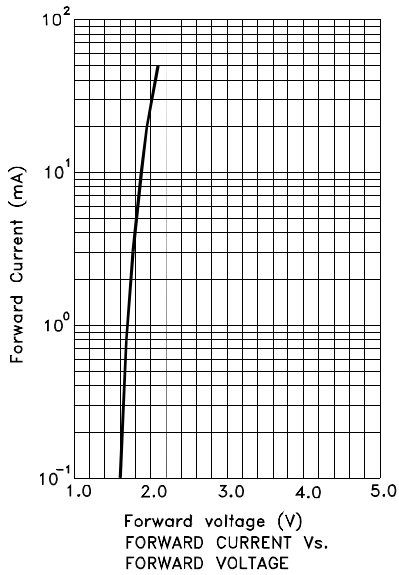
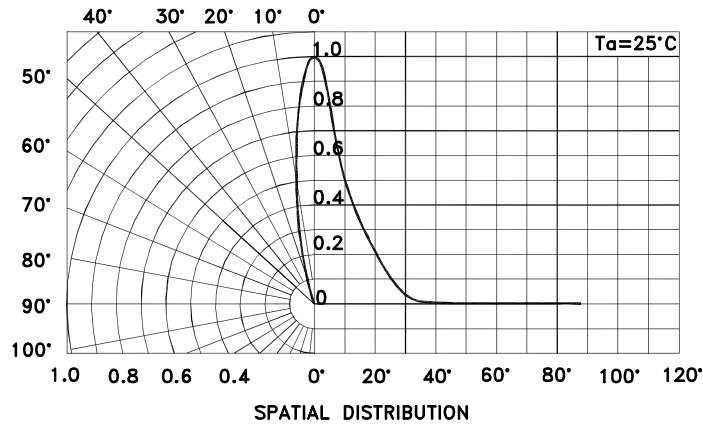

WP7113SURCK-AMT

Wave Soldering Profile For Lead-free Through-hole LED.

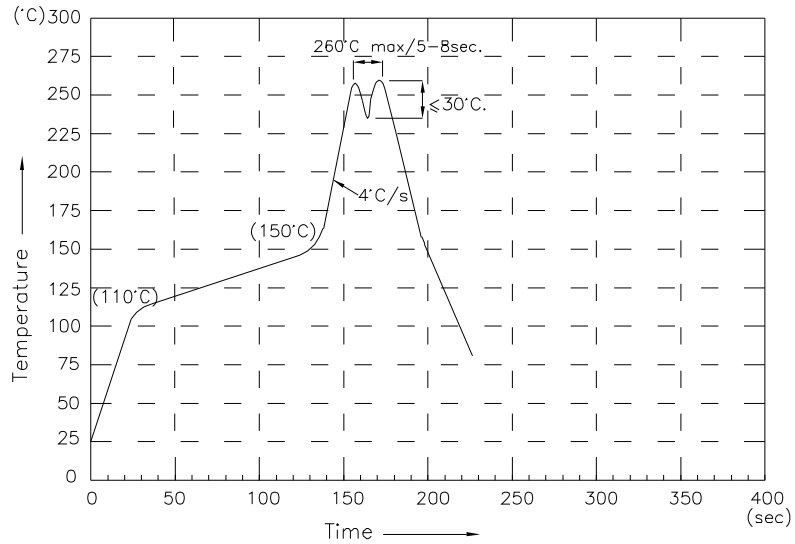

NOTES:

- 1.Recommend the wave temperature 245°C~260°C.The maximum soldering temperature should be less than 260°C.
- 2.Do not apply stress on epoxy resins when temperature is over 85 degree°C.
- 3.The soldering profile apply to the lead free soldering (Sn/Cu/Ag alloy).
- 4.No more than once.

**Recommended Soldering Pattern
(Units : mm; Tolerance: ±0.1)**

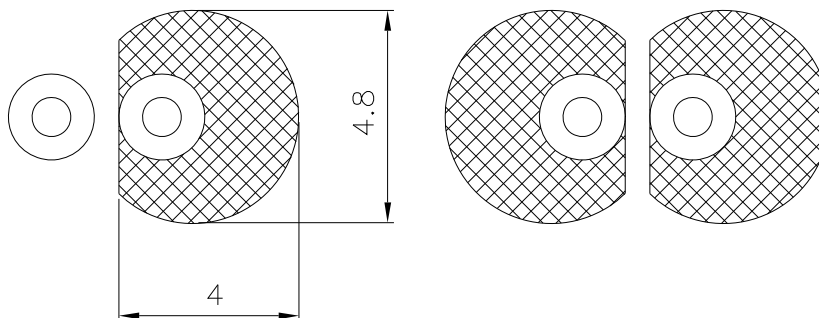

PACKING & LABEL SPECIFICATIONS

WP7113SURCK-AMT

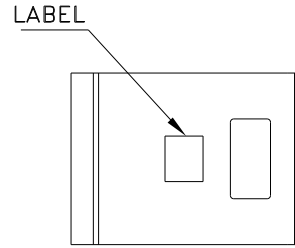
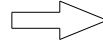
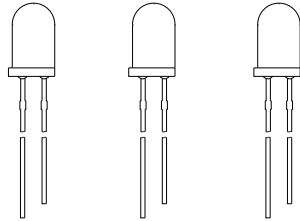

500PCS / BAG



20K / 9# BOX

OUTSIDE LABEL



OUTSIDE LABEL

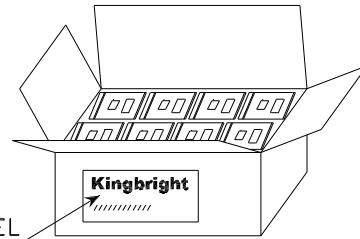

10K / 5# BOX

Kingbright

P/NO: WP7113xxx

QTY: 500 pcs

Q.C.

Q C

S/N: XXXX

XX XX XXXX
PASSED

CODE: XXX

LOT NO:



RoHS Compliant

Reliability Test Items And Conditions

The reliability of products shall be satisfied with items listed below

Lot Tolerance Percent Defective (LTPD) : 10%

No.	Test Item	Standards	Test Condition	Test Times / Cycles	Number of Damaged
1	Continuous operating test	-	Ta = 25°C ,IF = maximum rated current*	1,000 h	0 / 22
2	High Temp. operating test	EIAJ ED-4701/100(101)	Ta = 100°C IF = maximum rated current*	1,000 h	0 / 22
3	Low Temp. operating test	-	Ta = -40°C, IF = maximum rated current*	1,000 h	0 / 22
4	High temp. storage test	EIAJ ED-4701/100(201)	Ta = maximum rated storage temperature	1,000 h	0 / 22
5	Low temp. storage test	EIAJ ED-4701/100(202)	Ta = -40°C	1,000 h	0 / 22
6	High temp. & humidity storage test	EIAJ ED-4701/100(103)	Ta = 60°C, RH = 90%	1,000 h	0 / 22
7	High temp. & humidity operating test	EIAJ ED-4701/100(102)	Ta = 60°C, RH = 90% IF = maximum rated current*	1,000 h	0 / 22
8	Soldering reliability test	EIAJ ED-4701/100(301)	Moisture soak : 30°C,70% RH, 72h Preheat : 150~180°C(120s max.) Soldering temp : 260°C(10s)	3 times	0 / 18
9	Thermal shock operating test	-	Ta = -40°C(15min) ~ 100°C(15min) IF = derated current at 100°C	1,000 cycles	0 / 22
10	Thermal shock test	-	Ta = -40°C(15min) ~ maximum rated storage temperature(15min)	1,000 cycles	0 / 22
11	Electric Static Discharge (ESD)	EIAJ ED-4701/100(304)	C = 100pF , R2 = 1.5KΩ V = 3000V	Once each Polarity	0 / 22
12	Vibration test	-	a = 196m/s ² , f = 100~2KHz , t = 48min for all xyz axes	4 times	0 / 22

* : Refer to forward current vs. derating curve diagram

Failure Criteria

Items	Symbols	Conditions	Failure Criteria
luminous Intensity	Iv	IF = 20mA	Testing Min. Value < Spec.Min.Value x 0.5
Forward Voltage	Vf	IF = 20mA	Testing Max. Value ≥ Spec.Max.Value x 1.2
Reverse Current	IR	VR = Maximum Rated Reverse Voltage	Testing Max. Value ≥ Spec.Max.Value x 2.5
High temp. storage test	-	-	Occurrence of notable decoloration, deformation and cracking

LED MOUNTING METHOD

1. The lead pitch of the LED must match the pitch of the mounting holes on the PCB during component placement. Lead-forming may be required to insure the lead pitch matches the hole pitch. Refer to the figure below for proper lead forming procedures.

(Fig. 1)

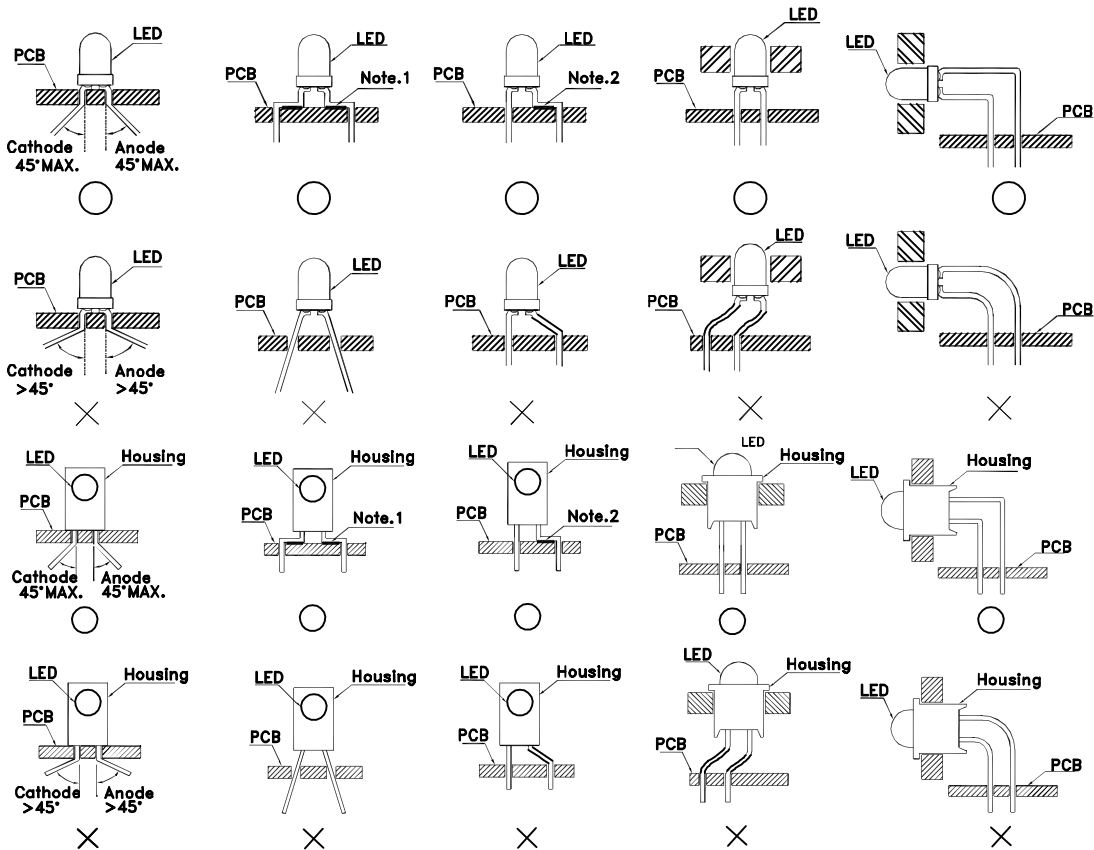

Fig.1

“O” Correct mounting method “X” Incorrect mounting method
 Note 1-2 : Do not route PCB trace in the contact area between the leadframe and the PCB to prevent short-circuits.

2. When soldering wire to the LED, use individual heat-shrink tubing to insulate the exposed leads to prevent accidental contact short-circuit.
 (Fig. 2)

3. Use stand-offs (Fig. 3) or spacers (Fig. 4) to securely position the LED above the PCB.

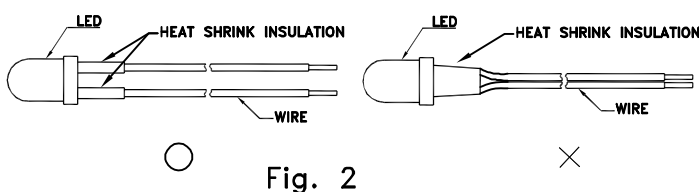

Fig. 2

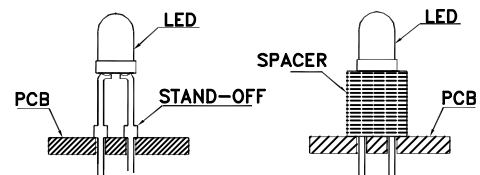

Fig. 3

Fig. 4

LEAD FORMING PROCEDURES

1. Maintain a minimum of 2mm clearance between the base of the LED lens and the first lead bend. (Fig. 5 and 6)

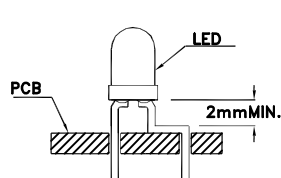

Fig. 5

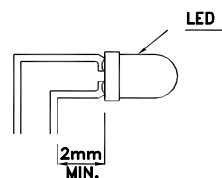

Fig. 6

2. Lead forming or bending must be performed before soldering, never during or after Soldering.
3. Do not stress the LED lens during lead-forming in order to fractures in the lens epoxy and damage the internal structures.
4. During lead forming, use tools or jigs to hold the leads securely so that the bending force will not be transmitted to the LED lens and its internal structures. Do not perform lead forming once the component has been mounted onto the PCB. (Fig. 7)
5. Do not bend the leads more than twice. (Fig. 8)
6. After soldering or other high-temperature assembly, allow the LED to cool down to 50°C before applying outside force (Fig. 9). In general, avoid placing excess force on the LED to avoid damage. For any questions please consult with Kingbright representative for proper handling procedures.

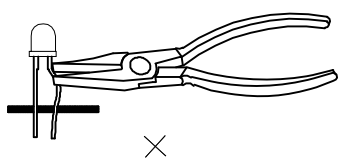

Fig. 7

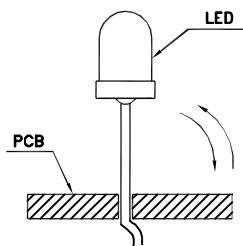

Fig. 8

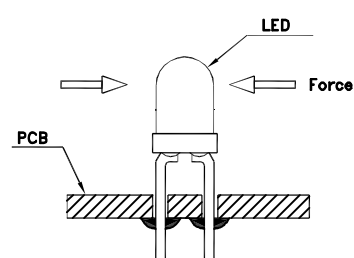

Fig. 9

7. No stress shall be applied on the LED during soldering to prevent damage.

