

Part Number: WP7113BR9.52/YD

YELLOW

Features

- LED FIRMLY HELD BY SPACER-NO ADDITIONAL FIXTURING OR GLUEING NECESSARY.
- SUITABLE FOR BACK PANEL ILLUMINATION, CIRCUIT BOARD INDICATOR, LED INDICATOR.
- UL RATING: 94V-0.
- HOUSING MATERIAL: TYPE 66 NYLON.
- RoHS COMPLIANT.

Description

The Yellow source color devices are made with Gallium Arsenide Phosphide on Gallium Phosphide Yellow Light Emitting Diode.

Package Dimensions

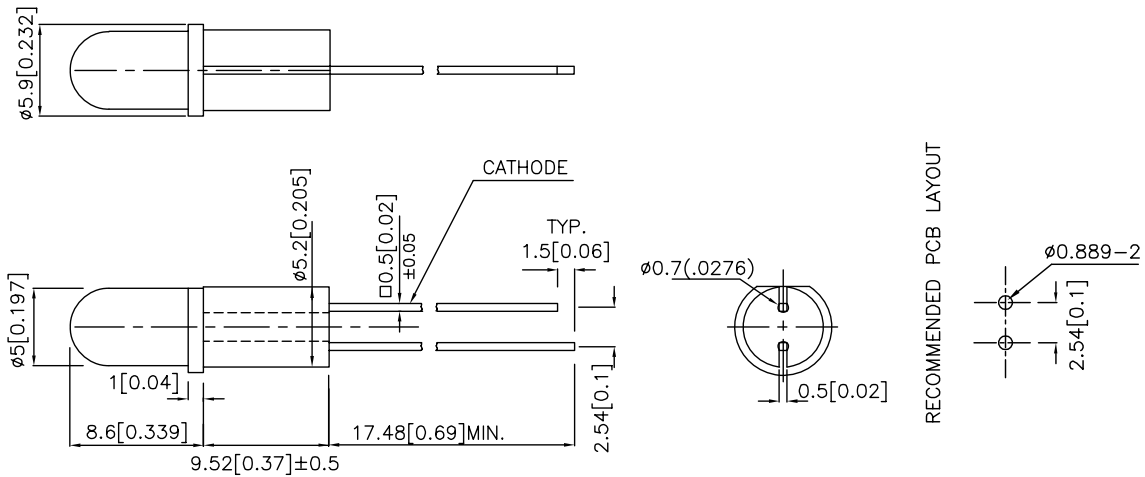

Notes:

1. All dimensions are in millimeters (inches).
2. Tolerance is $\pm 0.25 (0.01)$ unless otherwise noted.
3. Lead spacing is measured where the leads emerge from the package.
4. Specifications are subject to change without notice.



Selection Guide

Part No.	Dice	Lens Type	Iv (mcd) [2] @ 10mA		Viewing Angle [1]
			Min.	Typ.	2 θ 1/2
WP7113BR9.52/YD	YELLOW (GaAsP/GaP)	YELLOW DIFFUSED	5	20	30°

Notes:

1. θ 1/2 is the angle from optical centerline where the luminous intensity is 1/2 the optical centerline value.
2. Luminous intensity/ luminous Flux: +/-15%.

Electrical / Optical Characteristics at TA=25°C

Symbol	Parameter	Device	Typ.	Max.	Units	Test Conditions
λ_{peak}	Peak Wavelength	Yellow	590		nm	IF=20mA
λ_D [1]	Dominant Wavelength	Yellow	588		nm	IF=20mA
$\Delta\lambda_{1/2}$	Spectral Line Half-width	Yellow	35		nm	IF=20mA
C	Capacitance	Yellow	20		pF	VF=0V;f=1MHz
VF [2]	Forward Voltage	Yellow	2.1	2.5	V	IF=20mA
IR	Reverse Current	Yellow		10	uA	VR= 5V

Notes:

1. Wavelength: +/-1nm.
2. Forward Voltage: +/-0.1V.

Absolute Maximum Ratings at TA=25°C

Parameter	Yellow	Units
Power dissipation	75	mW
DC Forward Current	30	mA
Peak Forward Current [1]	140	mA
Reverse Voltage	5	V
Operating / Storage Temperature	-40°C To +85°C	
Lead Solder Temperature [2]	260°C For 3 Seconds	
Lead Solder Temperature [3]	260°C For 5 Seconds	

Notes:

1. 1/10 Duty Cycle, 0.1ms Pulse Width.
2. 2mm below package base.
3. 5mm below package base.

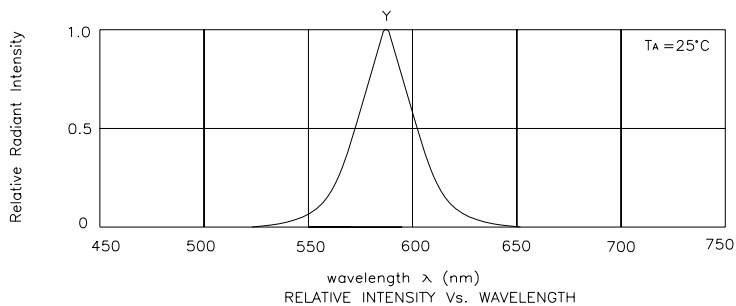

Yellow

WP7113BR9.52/YD

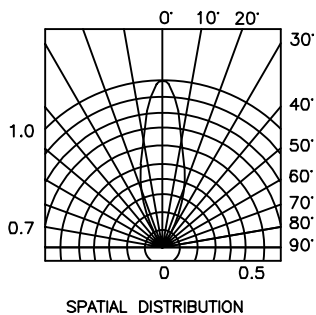
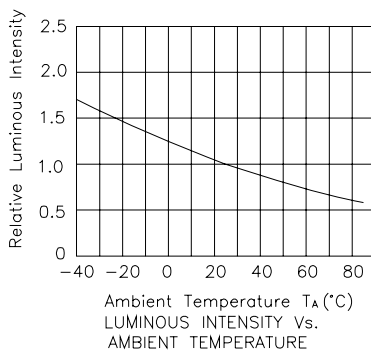
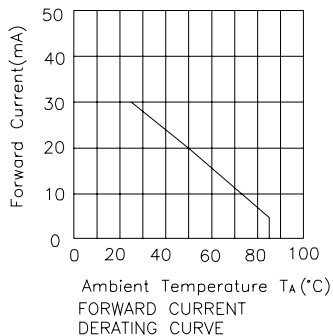
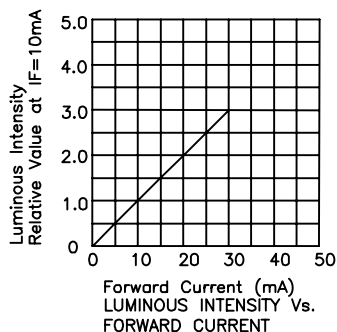
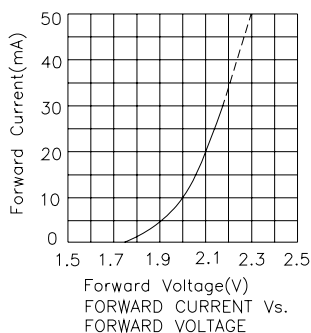

PACKING & LABEL SPECIFICATIONS

WP7113BR9.52/YD

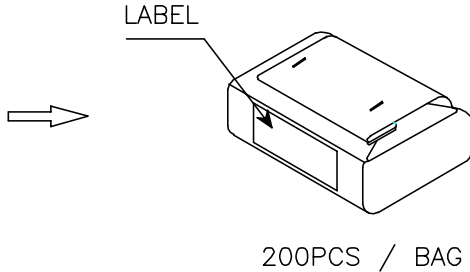
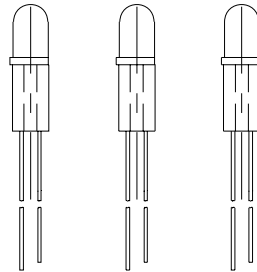

12.8K / 9# BOX

OUTSIDE LABEL

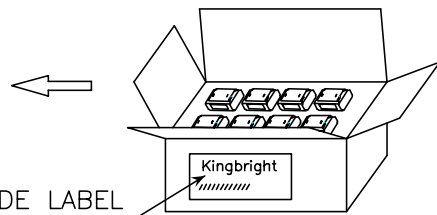

1.6K / 1# BOX

<h2 style="margin: 0;">Kingbright</h2>	
Q.C.	<div style="border: 1px solid black; border-radius: 50%; padding: 5px; display: inline-block;"> QC xxx xx xxxx PASSED </div>
TYPE NO : WP7113BR9.52/YD	
QUANTITY : 200 pcs	
S/N : XXX	CODE: XX
LOT NO :	
MADE IN CHINA	RoHS Compliant