

Energy Management Power Analyzer Type WM14-96 "Basic Version"

CARLO GAVAZZI



- Optional dual pulse output
- Alarms (visual only) V_{LN} , A_n
- Optional galvanically insulated measuring inputs

Product Description

3-phase power analyzer with built-in programming keypad. Particularly recommended for displaying the main electrical variables. Housing for panel mounting,

(front) protection degree IP65, and optional RS485 serial port or dual pulse output. Parameters programmable by means of CptBSoft.

- Class 1 (active energy)
- Class 2 (reactive energy)
- Accuracy ± 0.5 F.S. (current/voltage)
- Power analyzer
- Display of instantaneous variables: 3x3 digit
- Display of energies: 8+1 digit
- System variables and phase measurements: W , W_{dmd} , var, VA, VA_{dmd} , PF, V, A, A_n , A_{dmd} , Hz
- A_{max} , $A_{dmd max}$, $W_{dmd max}$ indication
- Energy measurements: kWh and kvarh
- Hour counter (5+2 DGT)
- TRMS meas. of distorted sine waves (voltages/currents)
- Power supply: 24V, 48V, 115V, 230V, 50-60Hz; 18 to 60VDC
- Protection degree (front): IP65
- Front dimensions: 96x96mm
- Optional RS422/485 serial port

How to order **WM14-96 AV5 3 D PG**

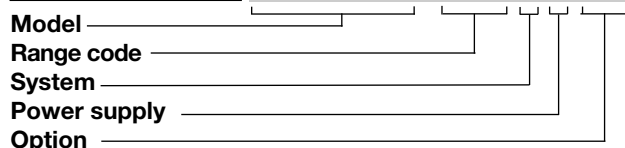

How to order **CptBSoft**

CptBSoft (compatible only with S or SG options): software to program the working parameters of the power analyzer and to read the energy and the instantaneous variables.

Type Selection

Range codes	System	Power supply	Options
AV5: 380/660V _{L-L} /5(6)AAC VL-N: 185 V to 460 V VL-L: 320 V to 800 V AV6: 120/208V _{L-L} /5(6)AAC VL-N: 45 V to 145 V VL-L: 78 V to 250 V Phase current: 0.03A to 6A Neutral current: 0.09 to 6A	3: 1-2-3-phase, balanced/unbalanced load, with or without neutral	A: 24VAC -15+10%, 50-60Hz B: 48VAC -15+10%, 50-60Hz C: 115VAC -15+10%, 50-60Hz D: 230VAC -15+10%, 50-60Hz 3: 18 to 60VDC (not available in case of SG or PG options)	X: None S: RS485 port SG: RS485+galvanic insulated measuring inputs PG: Dual pulse output + galvanically insulated measuring inputs.

Input specifications

Rated inputs	System	Additional errors	Options
Current "X-S options" Current "SG-PG options" Voltage	3 (non insulated each other) 3 (insulated each other) 4	Active energy "X-S option" Reactive energy "X-S option" Active energy "SG-PG opt." Reactive energy "SG-PG opt." Frequency	0.03A to 0.25A: $\pm 2\%$ FS +5DGT Class 2 (start up "I": 30mA) Class 3 (start up "I": 30mA) Class 1 (start up "I": 30mA) Class 2 (start up "I": 30mA) ± 0.1 Hz (48 to 62Hz)
Accuracy (display, RS485) (@25°C $\pm 5^\circ\text{C}$, R.H. $\leq 60\%$)	with CT=1 and VT=1 AV5: 1150W-VA-var, FS:230VLN, 400VLL; AV6: 285W-VA-var, FS:57VLN, 100VLL	Humidity	$\leq 0.3\%$ FS, 60% to 90% RH
Current	0.25 to 6A: $\pm(0.5\%$ FS +1DGT) 0.03A to 0.25A: $\pm(0.5\%$ FS +7DGT)	Temperature drift	≤ 200 ppm/ $^\circ\text{C}$
Neutral current	0.25 to 6A: $\pm(1.5\%$ FS +1DGT) 0.09A to 0.25A: $\pm(0.5\%$ FS +7DGT)	Sampling rate	1400 samples/s @ 50Hz 1700 samples/s @ 60Hz
Phase-phase voltage	$\pm(1.5\%$ FS +1 DGT)	Display refresh time	700ms
Phase-neutral voltage	$\pm(0.5\%$ FS + 1 DGT)	Display	LED, 14mm 3x3 DGT
Active and Apparent power,	0.25 to 6A: $\pm(1\%$ FS +1DGT); 0.03A to 0.25A: $\pm(1\%$ FS +5DGT)	Type Read-out for instant. var. Read-out for energies	3+3+3 DGT (Max indication: 999 999 99.9)
Reactive power	0.25 to 6A: $\pm(2\%$ FS +1DGT);		



Input specifications (cont.)

Display (cont.) Read-out for hour counter	1+3+3 DGT (Max. indication: 9 999 9.99)	120/208V _{L-L} (AV6) Current	453 K Ω \pm 5% \leq 0.02 Ω
Measurements	Current, voltage, power, power factor, frequency, energy, TRMS measurement of distorted waves.	Input impedance 380/660V _{L-L} (AV5) 120/208V _{L-L} (AV6) Current	(PG-SG options) 1 M Ω \pm 1% 1 M Ω \pm 1% \leq 0.02 Ω
Coupling type Crest factor	Direct < 3, max 10A peak	Frequency	48 to 62 Hz
Input impedance 380/660V _{L-L} (AV5)	(X-S options) 1 M Ω \pm 5%	Overload protection Continuous voltage/current For 500ms: voltage/current	1.2 F.S. 2 Un/36A

RS485 Serial Port Specifications

RS422/RS485 (on request) Type	Multidrop bidirectional (static and dynamic variables)	Data (bidirectional) Dynamic (reading only)	System, phase variables and energies All configuration parameters 1 bit di start , 8 data bit, no parity, 1 stop bit 9600 bit/s
Connections	2 or 4 wires, max. distance 1200m, termination directly on the instrument	Static (writing only) Data format	
Addresses Protocol	1 to 255, key-pad selectable MODBUS/JBUS	Baud-rate	

CptBSoft software: parameter programming and reading data

CptBSoft	Multi language software to program the working parameters of the power analyzer and to read the energies and the instantaneous variables. The program runs under Windows 95/98/98SE/2000/	Working mode	NT/XP. Two different working modes can be selected: - management of a local RS485 network; - management of communication from a single instrument to PC (RS232);
		Data access	By means of RS485 serial port.

Dual pulse output

Digital outputs (on request) Pulse outputs Number of outputs Number of pulses	2 (one for kWh one for kvarh) From 0.01 to 999 in compliance with the following formula: [Psys max (kW or kvar)* pulses (pulses/kWh or kvarh)] <14400	Pulse duration	Electrical life: min 2*10 ⁵ cycles Mechanical life: 5*10 ⁶ cycles \geq 100ms <120ms (ON) \geq 100ms (OFF) According to EN622053-31 By means of relays, 4000 V _{RMS} outputs to measuring inputs, 4000 V _{RMS} output to supply input. Insulation between the two outputs: 1000V _{RMS}
Output type	Relay min current: 0.05A@250VAC/30VDC max current: 5A@250VAC/30VDC	Insulation	

Software functions

Password	Numeric code of max. 3 digits; 2 protection levels of the programming data Password "0", no protection		Page 5: An, An Alarm Page 6: W L1, W L2, W L3 Page 7: PF L1, PF L2, PF L3 Page 8: var L1, var L2, var L3 Page 9: VA L1, VA L2, VA L3 Page 10: VA Σ , W Σ , var Σ Page 11: VA dmd, W dmd, Hz Page 12: W dmd max (*) Page 13: Wh (*) Page 14: varh (*) Page 15: VL-L Σ , PF Σ , VLN Alarm
1st level	3-phase with/without n, unbal. 3-phase balanced 3-phase ARON, unbalanced 2-phase Single phase		Page 16: A max (*) Page 17: A dmd max (*) Page 18: hour counter (*) (*) = These variables are stored in EEPROM when the instrument is switched off
2nd level			
System selection			
Transformer ratio			
CT	1 to 999		
VT	1.0 to 99.9		
Filter			
Operating range	0 to 100% of the input display scale		
Filtering coefficient	1 to 16	Alarms	Programmable, for the VL Σ and An (neutral current). Note: the alarm is only visual, by means of LED on the front of the instrument.
Filter action	Measurements, alarms, serial out. (fundamental var: V, A, W and their derived ones).	Reset	Independent alarm (VL Σ , An) max: A dmd, W dmd all energies (Wh, varh) and hour counter
Displaying			
3-phase system with neutral	Up to 3 variables per page Page 1: V L1, V L2, V L3 Page 2: V L12, V L23, V L31 Page 3: A L1, A L2, A L3 Page 4: A L1 dmd, A L2 dmd, A L3 dmd		

Power Supply Specifications

Auxiliary power supply	230VAC -15 +10%, 50-60Hz 115VAC -15 +10%, 50-60Hz 48VAC -15 +10%, 50-60Hz		24VAC -15 +10%, 50-60Hz 18 to 60VDC
		Power consumption	AC: 4.5 VA DC: 4W

General Specifications

Operating temperature	0 to +50°C (32 to 122°F) (RH < 90% non condensing)		measuring inputs and RS485. 4000VAC, 500VDC between power supply and RS485
Storage temperature	-30 to +60°C (-22 to 140°F) (RH < 90% non condensing)	Dielectric strength	4000 VAC (for 1 min)
Installation category	Cat. III (IEC 60664, EN60664)	EMC	
Insulation (for 1 minute)	4000VAC, 500VDC between measuring inputs and power supply. 500VAC/DC between	Emissions	EN50084-1 (class A) residential environment, commerce and light industry

General Specifications (cont.)

EMC (cont.) Immunity	EN61000-6-2 (class A) industrial environment.	Housing Dimensions (WxHxD)	96 x 96 x 63 mm
Pulse voltage (1.2/50µs)	EN61000-4-5	Material	ABS self-extinguishing: UL 94 V-0
Safety standards	IEC60664, EN60664	Mounting	Panel
Approvals	CE, (cURus, CSA only "X" and "S" options)	Protection degree	Front: IP65 (standard), NEMA4x, NEMA12 Connections: IP20
Connections 5(6) A Max cable cross sect. area	Screw-type 2.5 mm ²	Weight	Approx. 400 g (pack. incl.)

Display pages

Display variables in 3-phase systems (in a 3-phase system with neutral)

No	1 st variable	2 nd variable	3 rd variable	Note
1	V L1	V L2	V L3	
2	V L12	V L23	V L31	Decimal point blinking on the right of the display
3	A L1	A L2	A L3	
4	A L1 dmd	A L2 dmd	A L3 dmd	dmd = demand (integration time selectable from 1 to 30 minutes)
5	An	AL.n		AL.n if neutral current alarm is active
6	W L1	W L2	W L3	Decimal point blinking on the right of the display if generated power
7	PF L1	PF L2	PF L3	
8	var L1	var L2	var L3	Decimal point blinking on the right of the display if generated power
9	VA L1	VA L2	VA L3	
10	VA system	W system	var system	
11	VA dmd (system)	W dmd (system)	Hz (system)	dmd = demand (integration time selectable from 1 to 30 minutes)
12		W dmd MAX		Maximum sys power demand
13	Wh (MSD)	Wh	Wh (LSD)	The total indication is given in max 3 groups of 3 digits.
14	varh (MSD)	varh	varh (LSD)	The total indication is given in max 3 groups of 3 digits.
15	V LL system	AL.U	PF system	AL.U= is activated only if one of VLN is not within the set limits.
16	A MAX			max. current among the three phases
17	A dmd max			max. dmd current among the three phases
18	h			hour counter

MSD: most significant digit

LSD: least significant digit

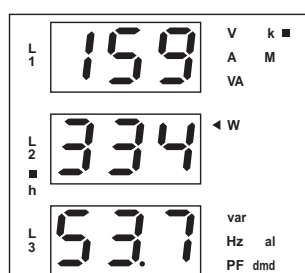

1) Example of kWh visualization:

This example is showing 15 933 453.7 kWh

2) Example of kvarh visualization:

This example is showing 3 553 944.9 kvarh

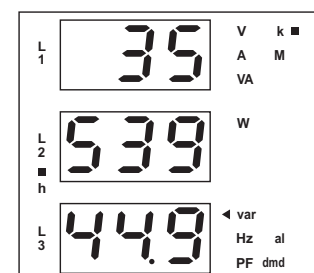

Waveform of the signals that can be measured

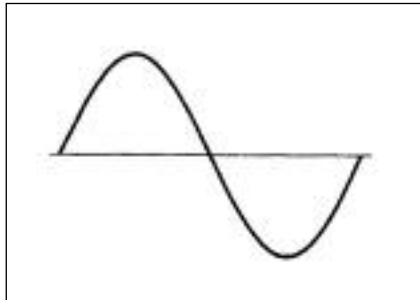

Figure A
Sine wave, undistorted
 Fundamental content 100%
 Harmonic content 0%
 $A_{rms} = 1.1107 | \bar{A} |$

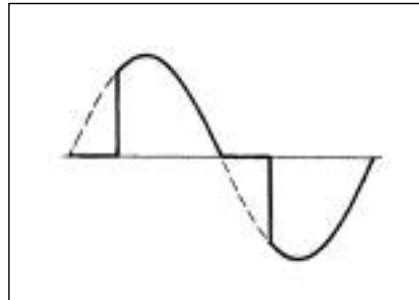

Figure B
Sine wave, indented
 Fundamental content 10...100%
 Harmonic content 0...90%
 Frequency spectrum: 3rd to 16th harmonic
 Additional error: <1% FS

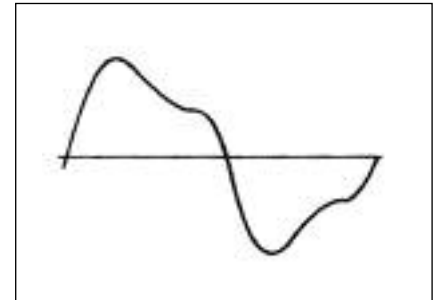
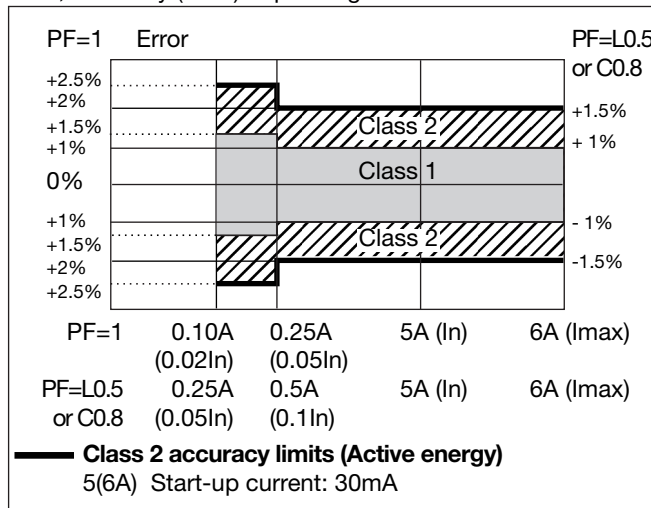

Figure C
Sine wave, distorted
 Fundamental content 70...90%
 Harmonic content 10...30%
 Frequency spectrum: 3rd to 16th harmonic
 Additional error: <0.5% FS

Accuracy

kWh, accuracy (RDG) depending on the current



kvarh, accuracy (RDG) depending on the current

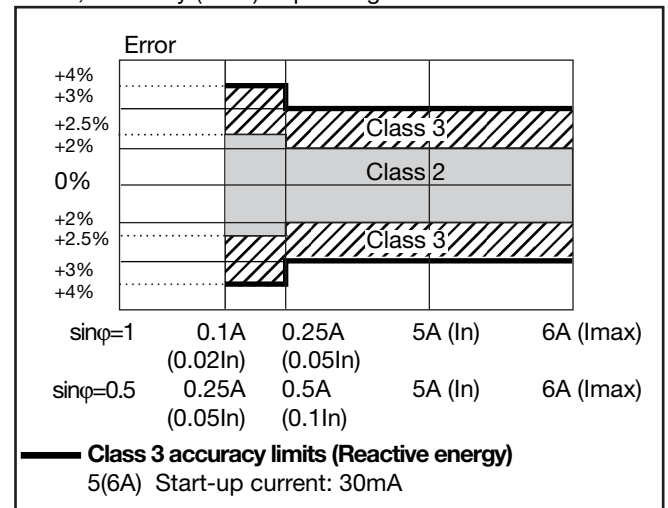

: this graph is only referred to instrument models with the "SG or PG" option.

: this graph is only referred to instrument models with the "X or S" option.

Used calculation formulas

Phase variables

Instantaneous effective voltage

$$V_{IN} = \sqrt{\frac{1}{n} \cdot \sum_{i=1}^n (V_{1N})_i^2}$$

Instantaneous active power

$$W_1 = \frac{1}{n} \cdot \sum_{i=1}^n (V_{1N})_i \cdot (A_1)_i$$

Instantaneous power factor

$$\cos\phi_1 = \frac{W_1}{VA_1}$$

Instantaneous effective current

$$A_1 = \sqrt{\frac{1}{n} \cdot \sum_{i=1}^n (A_1)_i^2}$$

Instantaneous apparent power

$$VA_1 = V_{1N} \cdot A_1$$

Instantaneous reactive power

$$VAR_1 = \sqrt{(VA_1)^2 - (W_1)^2}$$

System variables

Equivalent 3-phase voltage

$$V_{\Sigma} = \frac{V_1 + V_2 + V_3}{3} \cdot \sqrt{3}$$

3-phase reactive power

$$VAR_{\Sigma} = (VAR_1 + VAR_2 + VAR_3)$$

3-phase active power

$$W_{\Sigma} = W_1 + W_2 + W_3$$

3-phase apparent power

$$VA_{\Sigma} = \sqrt{W_{\Sigma}^2 + VAR_{\Sigma}^2}$$

3-phase power factor

$$\cos\phi_{\Sigma} = \frac{W_{\Sigma}}{VA_{\Sigma}}$$

Neutral current

$$A_n = \bar{A}_{L1} + \bar{A}_{L2} + \bar{A}_{L3}$$

Used calculation formulas (cont.)

$$kWh_i = \int_{t_1}^{t_2} P_i(t) dt \approx \Delta t \sum_{n_1}^{n_2} P_{i,n}$$

$$kVarh_i = \int_{t_1}^{t_2} Q_i(t) dt \approx \Delta t \sum_{n_1}^{n_2} Q_{i,n}$$

Energy metering

Where:

i = considered phase (L1, L2 or L3)

P = active power

Q = reactive power

t_1, t_2 = starting and ending time points of consumption recording

n = time unit

Δt = time interval between two successive power consumptions

n_1, n_2 = starting and ending discrete time points of consumption recording

Wiring diagrams

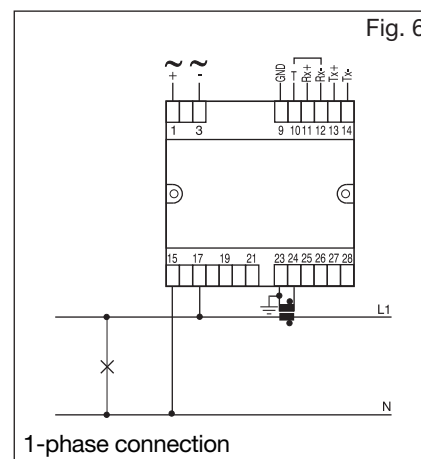
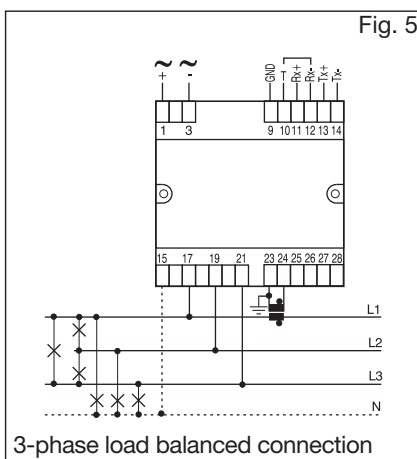
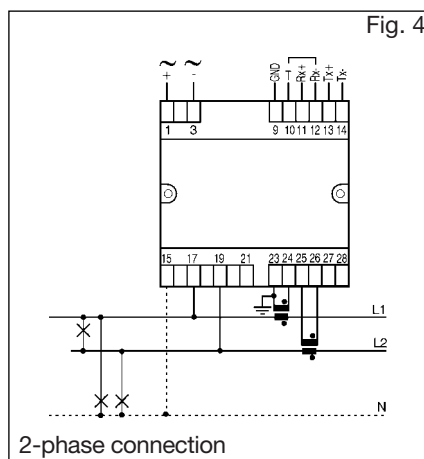
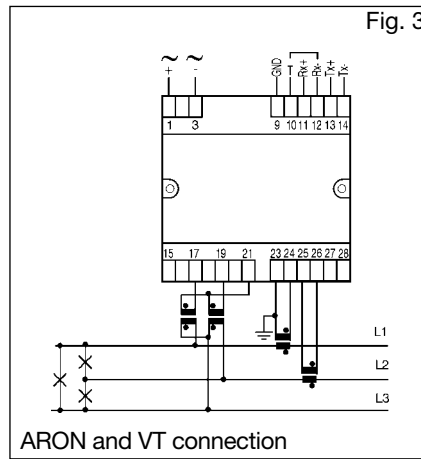
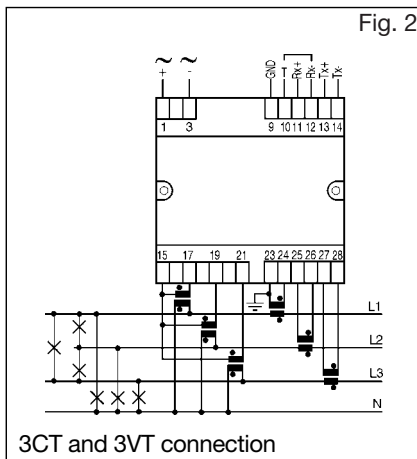
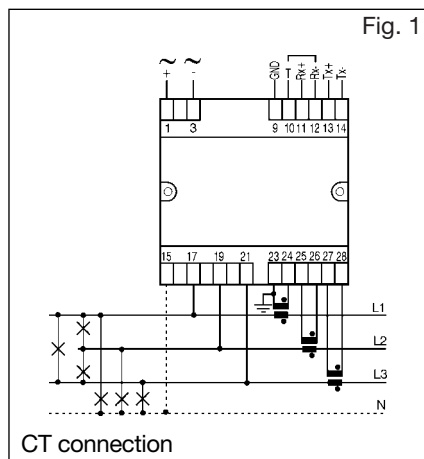

NOTE: Only for “PG” and “SG” options: the current measuring inputs are galvanically insulated and therefore they can be connected to ground singly.

NOTE: For all models except for “PG” or “SG” the current inputs can be connected to the lines ONLY by means of current transformers. The direct connection is not allowed.

ATTENTION: only one ammeter input can be connected to earth, as shown in the electrical diagrams.

RS485 port connections

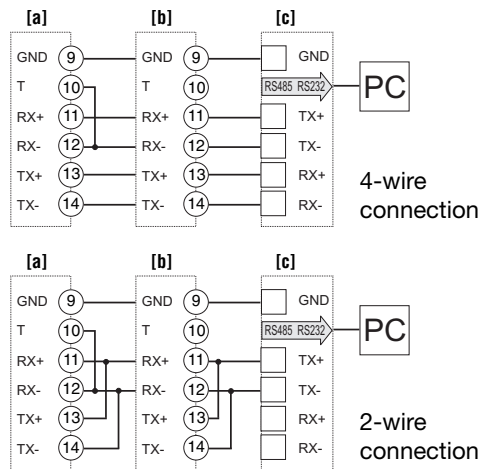
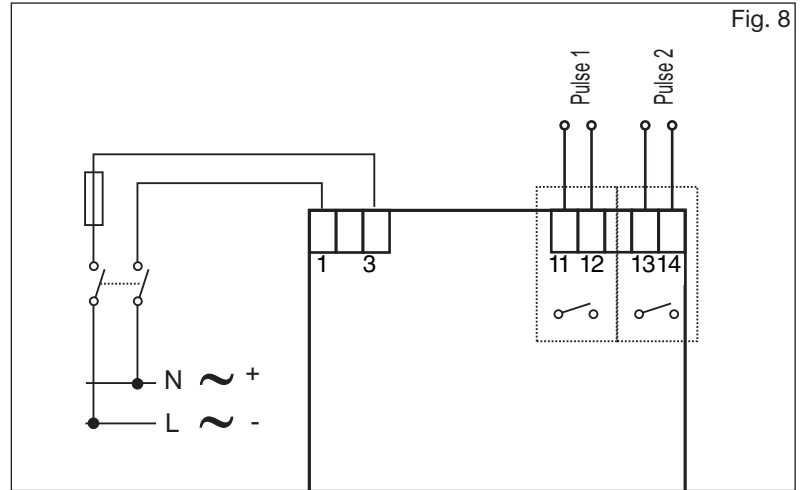
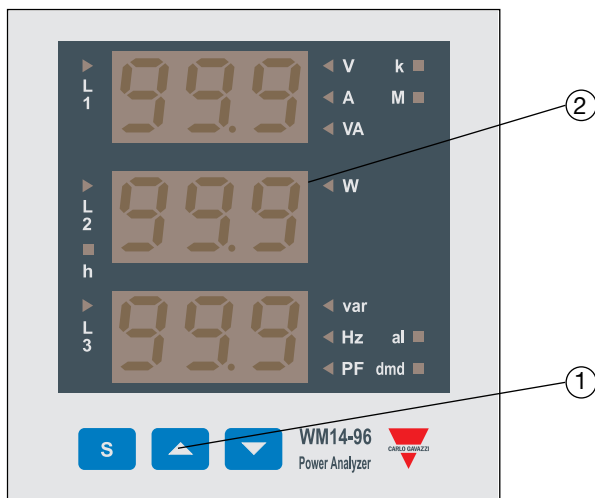

Fig. 7: **a**-Last instrument; **b**-1...n Instrument
c-RS485/232 serial converter

Dual pulse output connections



Front Panel Description



1. Key-pad

To program the configuration parameters and the display of the variables.

S

Key to enter programming and confirm selections;



Keys to:

- programme values;
- select functions;
- display measuring pages.

2. Display

LED-type with alphanumeric indications to:

- display configuration parameters;
- display all the measured variables.

Dimensions and Panel Cut-out

