

Features

Switching Zero cross

Output Back to back SCR with internal snubber

Input AC (Input Resistance of 30K Ω)

Applications

Resistive and inductive loads with $\cos\phi > 0.85$

Technical data

WG 280 A...	10 Z	25 Z	45 Z	50 Z
Input circuit				
Control voltage range	90...280 VAC			
Control current max.	10 mA			
Turn-off voltage min.	10 VDC			
Input resistance	30K Ω			
Output circuit				
Load voltage range	24...280 VAC			
Peak-off state voltage	600 V _{drm}			
Off-state leakage current	6 mA eff.		12 mA eff.	
Load current range	0,1...10 A	0,2...25 A	0,4...45 A	0,4...50 A
Surge current 1 half wave	110 A _{peak}	230 A _{peak}	500 A _{peak}	570 A _{peak}
I ² t for fusing	60 A ² s	260 A ² s	1250 A ² s	1620 A ² s
On-state voltage	1,6 V _{peak}			
Off-state (static) dV/dt	1000 V/ μ s			
Snubber	47 Ω / 47 nF		47 Ω / 100 nF	
General data				
Turn-on time max.	33 ms			
Turn-off time max.	33 ms			
Line frequency range	47...63 Hz			
Isolation volt. between input/output	4.000 V			
Isolation volt. between input-output/base	2.500 V			
Isolation resistance	50 M Ω			
Operation temperature	-20...+80 $^{\circ}$ C			
Recommended varistor	SIOV-S20 K230			
Approvals	UL, VDE			

Technical data

WG 280 A...	75 Z	90 Z	110 Z	125 Z
Input circuit				
Control voltage range	90...280 VAC			
Control current max.	10 mA			
Turn-off voltage min.	10 VDC			
Input resistance	30K Ω			
Output circuit				
Load voltage range	24...280 VAC			
Peak-off state voltage	600 V _{drm}			
Off-state leakage current	12 mA eff.			
Load current range	0,4...75 A	0,4...90 A	0,4...110 A	0,4...125 A
Surge current 1 half wave	910 A _{peak}	1090 A _{peak}	1350 A _{peak}	1590 A _{peak}
I ² t for fusing	4150 A ² s	5980 A ² s	9100 A ² s	12650 A ² s
On-state voltage	1,6 V _{peak}			
Off-state (static) dV/dt	1000 V/ μ s			
Snubber	47 Ω / 100 nF			
General data				
Turn-on time max.	33 ms			
Turn-off time max.	33 ms			
Line frequency range	47...63 Hz			
Isolation volt. between input/output	4.000 V			
Isolation volt. between input-output/base	2.500 V			
Isolation resistance	50 M Ω			
Operation temperature	-20...+80 °C			
Recommended varistor	SIOV-S20 K230			
Approvals	UL, VDE			

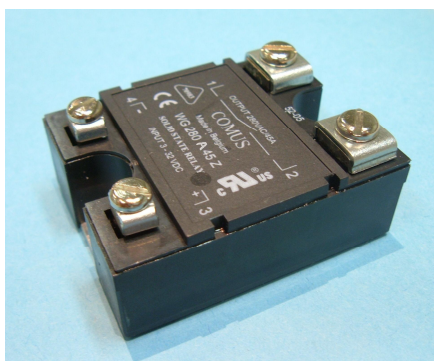

Features

Switching	Random
Output	Back to back SCR with internal snubber
Input	AC (Input Resistance of 30K Ω)
Applications	Inductive loads

Technical data

WG 280 A...	10 R	25 R	40 R	50 R
Input circuit				
Control voltage range	90...280 VAC			
Control current max.	10 mA			
Turn-off voltage min.	10 VDC			
Input resistance	30K Ω			
Output circuit				
Load voltage range	24...280 VAC			
Peak-off state voltage	600 V _{drm}			
Off-state leakage current	6 mA eff.	12 mA eff		
Load current range	0,1...10 A	0,2...25 A	0,4...40 A	0,4...50 A
Surge current 1 half wave	110 A _{peak}	230 A _{peak}	500 A _{peak}	570 A _{peak}
I ² t for fusing	60 A ² s	260 A ² s	1250 A ² s	1620 A ² s
On-state voltage	1,6 V _{peak}			
Off-state (static) dV/dt	1000 V/ μ s			
Snubber	47 Ω / 47 nF	47 Ω / 100 nF		
General data				
Turn-on time max.	0,1 ms			
Turn-off time max.	33 ms			
Line frequency range	47...63 Hz			
Isolation volt. between input/output	4.000 V			
Isolation volt. between input-output/base	2.500 V			
Isolation resistance	50 M Ω			
Operation temperature	-20...+80 $^{\circ}$ C			
Recommended varistor	SIOV-S20 K230			
Approvals	UL, VDE			

Technical data

WG 280 A...	75 R	90 R	110 R	125 R
Input circuit				
Control voltage range	90...280 VAC			
Control current max.	10 mA			
Turn-off voltage min.	10 VDC			
Input resistance	30K Ω			
Output circuit				
Load voltage range	24...280 VAC			
Peak-off state voltage	600 V _{drm}			
Off-state leakage current	12 mA eff.			
Load current range	0,4...75 A	0,4...90 A	0,4...110 A	0,4...125 A
Surge current 1 half wave	910 A _{peak}	1090 A _{peak}	1350 A _{peak}	1590 A _{peak}
I ² t for fusing	4150 A ² s	5980 A ² s	9100 A ² s	12650 A ² s
On-state voltage	1,6 V _{peak}			
Off-state (static) dV/dt	1000 V/ μ s			
Snubber	47 Ω / 100 nF			
General data				
Turn-on time max.	0,1 ms			
Turn-off time max.	33 ms			
Line frequency range	47...63 Hz			
Isolation volt. between input/output	4.000 V			
Isolation volt. between input-output/base	2.500 V			
Isolation resistance	50 M Ω			
Operation temperature	-20...+80 $^{\circ}$ C			
Recommended varistor	SIOV-S20 K230			
Approvals	UL, VDE			

Dimensions in mm & circuit diagram

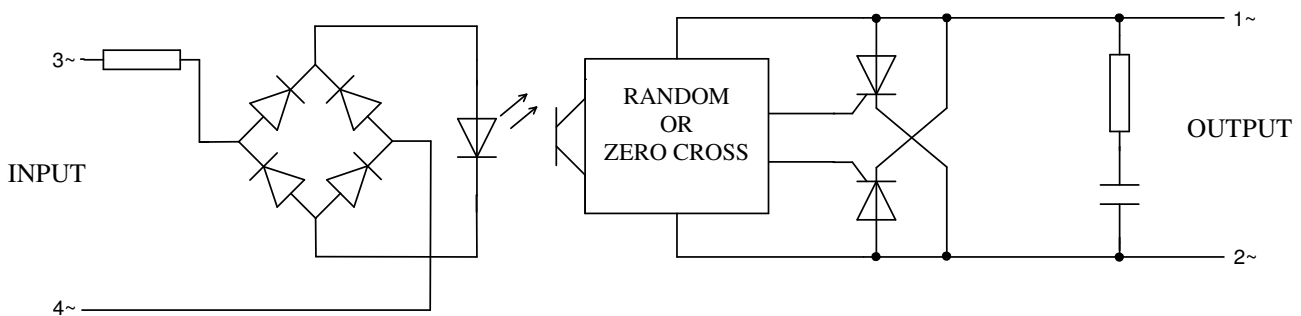
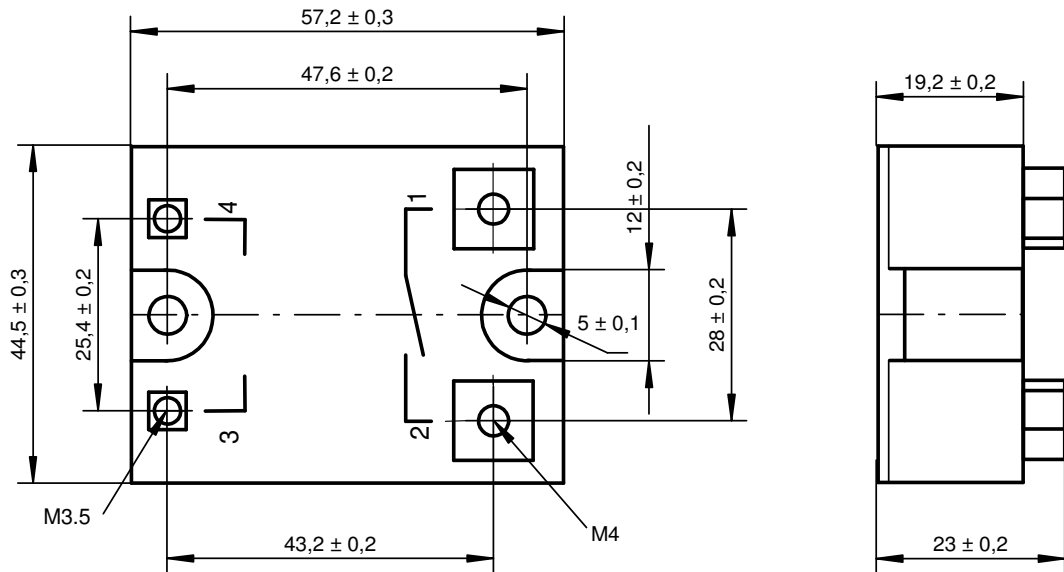

Housing specification

Weight	Approx. 100 gr)
Housing material	Glass filled polyester
Potting compound	UL recognized Epoxy
Base plate	10 ... 45 A : Aluminium 50 ... 125A : Aluminium , nickel plated
Terminals	Input : M4-screws Output : M3,5-screws

Derating-diagrams

UL recognised components: suitable for a max. surrounding air temperature of 40°C.
 For use at other ambient temperatures, check the derating diagrams.

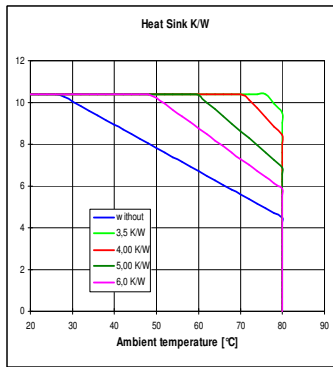
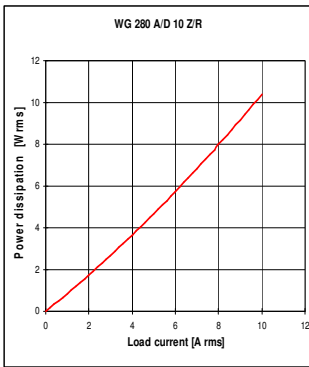

Heat sink	Number of SSR per heatsink/ load current per SSR		
	1 SSR	2 SSR	3 SSR
WG K1/100	10 A	10 A	
WG K2/100	10 A	10 A	
WG K3/160	10 A	10 A	10 A
WG K4/160L	10 A	10 A	10 A
WG K5/80	10 A		

Values for 40°C enclosure-temperature and mounted with conduction paste between the SSR and the heat sink

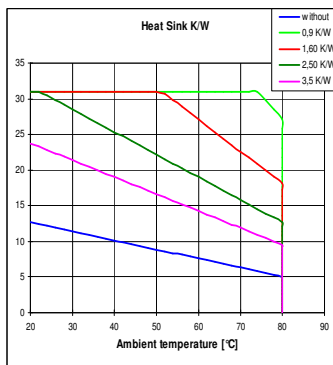
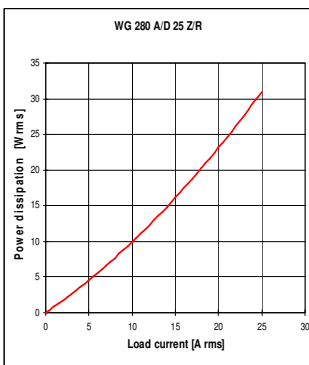

Heat sink	Number of SSR per heatsink/ load current per SSR		
	1 SSR	2 SSR	3 SSR
WG K1/100	18 A	12 A	
WG K2/100	23 A	17 A	
WG K3/160	25 A	25 A	23 A
WG K4/160L	25 A	25 A	25 A
WG K5/80	25 A		

Values for 40°C enclosure-temperature and mounted with conduction paste between the SSR and the heat sink

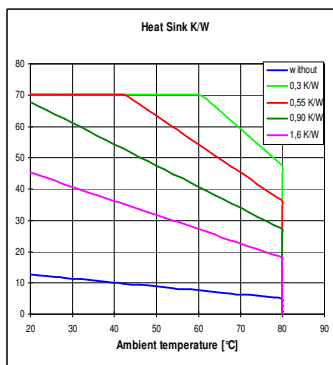
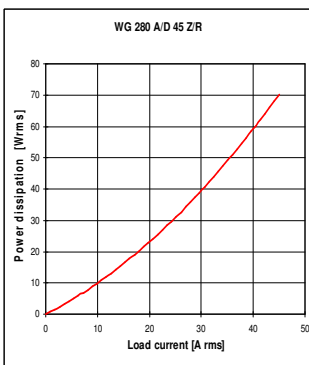

Heat sink	Number of SSR per heatsink/ load current per SSR		
	1 SSR	2 SSR	3 SSR
WG K1/100	18 A	12 A	
WG K2/100	23 A	17 A	
WG K3/160	40 A	29 A	23 A
WG K4/160L	45 A	45 A	41 A
WG K5/80	34 A		

Values for 40°C enclosure-temperature and mounted with conduction paste between the SSR and the heat sink

Derating-diagrams

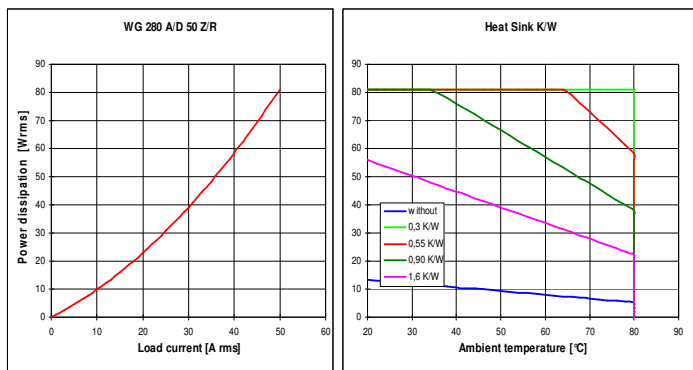

Number of SSR per heatsink/
load current per SSR

Heat sink	1 SSR	2 SSR	3 SSR
WG K1/100	20 A	13 A	
WG K2/100	26 A	18 A	
WG K3/160	50 A	34 A	26 A
WG K4/160L	50 A	50 A	50 A
WG K5/80	41A		

Values for 40°C enclosure-temperature and mounted with conduction paste between the SSR and the heat sink

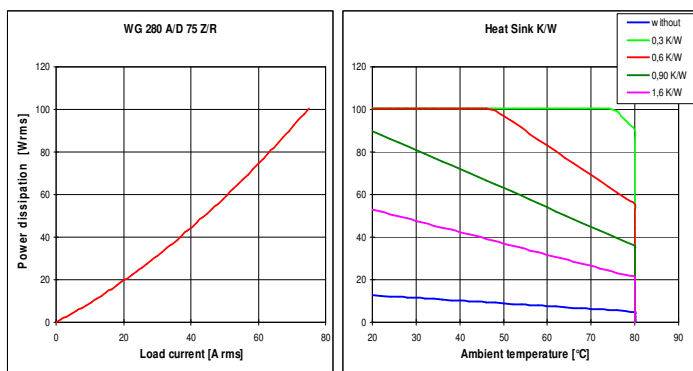

Number of SSR per heatsink/
load current per SSR

Heat sink	1 SSR	2 SSR	3 SSR
WG K1/100	23 A	14 A	
WG K2/100	31 A	21 A	
WG K3/160	66 A	42 A	31 A
WG K4/160L	75 A	75 A	68 A
WG K5/80	51 A		

Values for 40°C enclosure-temperature and mounted with conduction paste between the SSR and the heat sink

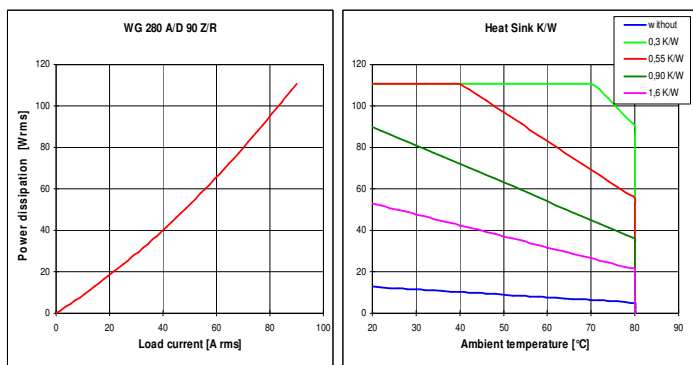

Number of SSR per heatsink/
load current per SSR

Heat sink	1 SSR	2 SSR	3 SSR
WG K1/100	25 A	15 A	
WG K2/100	33 A	22 A	
WG K3/160	73 A	45 A	33 A
WG K4/160L	90 A	90 A	76 A
WG K5/80	56 A		

Values for 40°C enclosure-temperature and mounted with conduction paste between the SSR and the heat sink

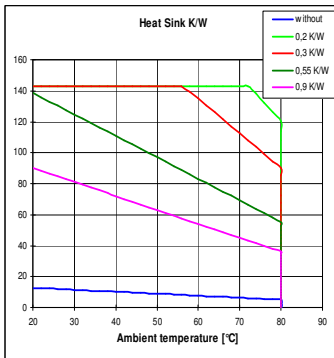
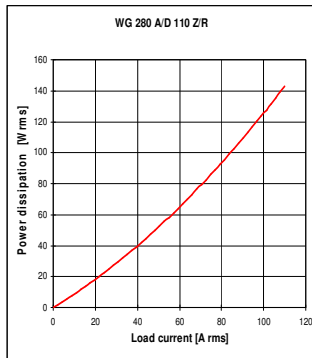

Number of SSR per Heatsink/ Load current per SSR

Heat sink	1 SSR	2 SSR	3 SSR
WG K1/100	25 A	15 A	
WG K2/100	33 A	22 A	
WG K3/160	74 A	46 A	33 A
WG K4/160L	110 A	103 A	77 A
WG K5/80	56 A		

Values for 40°C enclosure-temperature and mounted with conducting paste between the SSR and the heat sink

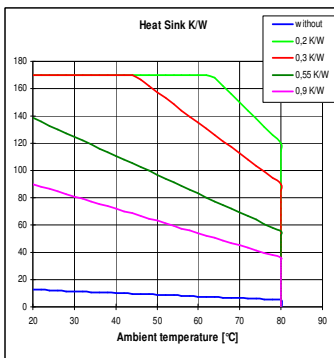
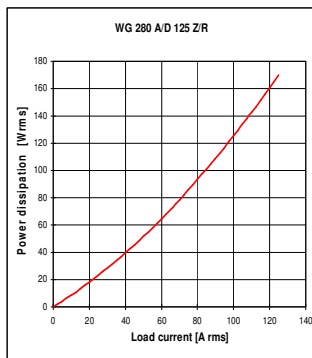

Number of SSR per Heatsink/ Load current per SSR

Heat sink	1 SSR	2 SSR	3 SSR
WG K1/100	25 A	15 A	
WG K2/100	33 A	22 A	
WG K3/160	74 A	46 A	33 A
WG K4/160L	125 A	103 A	77 A
WG K5/80	257A		

Values for 40°C enclosure-temperature and mounted with conducting paste between the SSR and the heat sink

Ordering

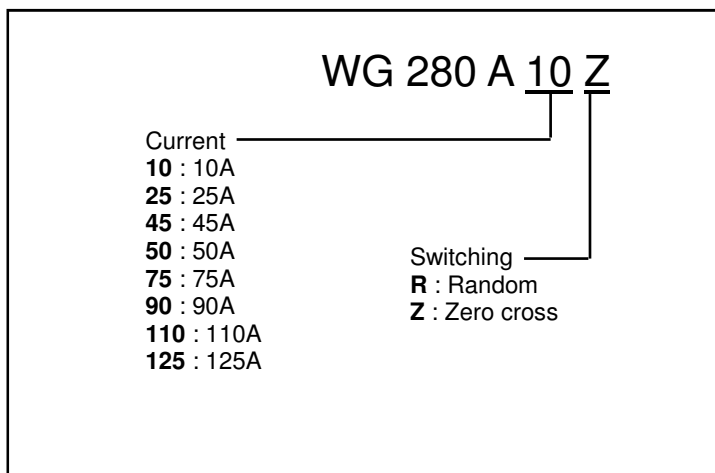

Description	Part Number
Protective case small	8440 5700 110
Thermal Conducting paste	8406 0180 020
Heat sink WG K1/100	5981 5701 100
Heat sink WG K2/100	5981 5701 110
Heat sink WG K3/160	5981 5701 370
Heat sink WG K4/160L	5981 5701 371
Heat sink WG K5/80	5981 5701 372
Mounting plate DIN rail	5981 5701 430