



## SERIES: VSK-S10-T | DESCRIPTION: AC-DC POWER SUPPLY

### FEATURES

- up to 10 W continuous output
- encapsulated compact case
- universal input (85~264 Vac)
- single regulated output from 3.3~24 Vdc
- over voltage, short circuit, and short circuit protection
- CE, UL safety approval
- efficiency up to 83%



MODEL	output voltage	output current	output power	ripple and noise <sup>1</sup>	efficiency
	(Vdc)	max (A)	max (W)	max (mVp-p)	max (%)
VSK-S10-3R3UA-T	3.3	2	6.6	100	72
VSK-S10-5UA-T	5	2	10	100	76
VSK-S10-9UA-T	9	1.1	10	100	80
VSK-S10-12UA-T	12	0.9	10	100	81
VSK-S10-15UA-T	15	0.7	10	100	82
VSK-S10-24UA-T	24	0.45	10	100	83

Notes: 1. Ripple and noise are measured at 20 MHz BW by "parallel cable" method with 1  $\mu$ F ceramic and 10  $\mu$ F electrolytic capacitors on the output.

### PART NUMBER KEY



## INPUT

parameter	conditions/description	min	typ	max	units
voltage		85		264	Vac
		100		370	Vdc
frequency		47		440	Hz
current	at 110 Vac		230		mA
	at 230 Vac		150		mA
inrush current	at 110 Vac		10		A
	at 230 Vac		20		A
input fuse	recommended external 2 A/250 V, slow-blow type				
temperature coefficient			±0.02		%/°C
no load power consumption			0.5		W

## OUTPUT

parameter	conditions/description	min	typ	max	units
capcitive load	3.3 Vdc model			15,000	µF
	5 Vdc model			12,000	µF
	9 Vdc model			6000	µF
	12 Vdc model			2000	µF
	15 Vdc model			1500	µF
	24 Vdc model			500	µF
line regulation	full load		±0.5		%
load regulation	at 10~100% load		±1		%
voltage set accuracy	3.3 Vdc model		±3		%
	all other models		±2		%
hold-up time	at 230 Vac		80		ms
switching frequency			65		kHz

## PROTECTIONS

parameter	conditions/description	min	typ	max	units
over voltage protection	3.3, 5 Vdc models			7.5	Vdc
	9 Vdc model			15	Vdc
	12, 15 Vdc models			20	Vdc
	24 Vdc model			30	Vdc
over current protection		110			%
short circuit protection	auto recovery				

## SAFETY & COMPLIANCE

parameter	conditions/description	min	typ	max	units
isolation voltage	input to output	4,000			Vac
safety approvals	UL60950-1				
safety class	Class II				
conducted emissions	CISPR11/EN55011, Class A, CISPR11/EN55011, Class B (external circuit required, see figure 2)				
radiated emissions	CISPR11/EN55011, Class A, CISPR11/EN55011, Class B (external circuit required, see figure 2)				
ESD	IEC/EN61000-4-2 Class B, contact ±6 kV/air ±8kV				
radiated immunity	IEC/EN61000-4-3 Class A, 10V/m				
EFT/burst	IEC/EN61000-4-4 Class B, ±2 kV				
	IEC/EN61000-4-4 Class B, ±4 kV (external circuit required, see figure 2)				
surge	IEC/EN61000-4-5 Class B, ±1 kV (external circuit required, see figure 1)				
	IEC/EN61000-4-5 Class B, ±2 kV / ±4 kV (external circuit required, see figure 2)				
conducted immunity	IEC/EN61000-4-6 Class A, 10 Vr.m.s				

## SAFETY & COMPLIANCE (CONTINUED)

parameter	conditions/description	min	typ	max	units
PFM	IEC/EN61000-4-8 Class A, 10 A/m				
voltage dips & interruptions	IEC/EN61000-4-11 Class B, 0%-70%				
MTBF	as per MIL-HDBK-217F, at 25°C	300,000			hours
RoHS	2011/65/EU				

## ENVIRONMENTAL

parameter	conditions/description	min	typ	max	units
operating temperature	see derating curves	-25		70	°C
storage temperature		-25		105	°C
storage humidity				95	%

## DERATING CURVES

load vs. ambient temperature

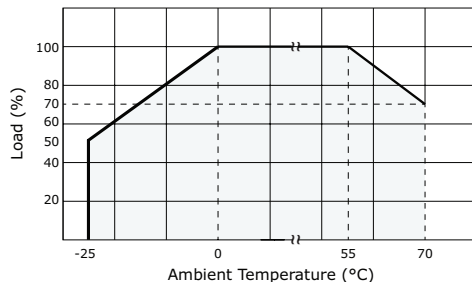

load vs. input voltage (Vac)

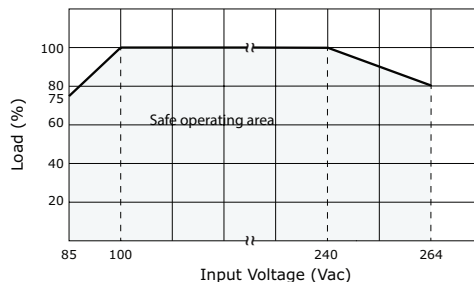

load vs. input voltage (Vdc)

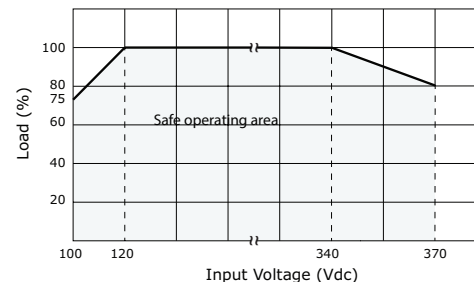

## MECHANICAL

parameter	conditions/description	min	typ	max	units
dimensions	76 x 31.50 x 27.80 (2.992 x 1.240 x 1.0944 inch)				mm
material	UL94V-0				
weight			70		g

## MECHANICAL DRAWING

units: mm [inch]  
tolerance: ±0.50 [±0.020]

wire range: 24~12 AWG

PIN CONNECTIONS	
PIN	FUNCTION
1	AC(N)
2	AC(L)
3	+Vo
4	-Vo

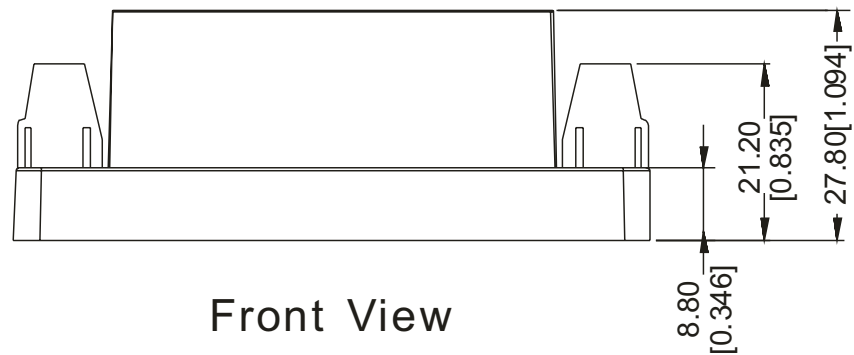
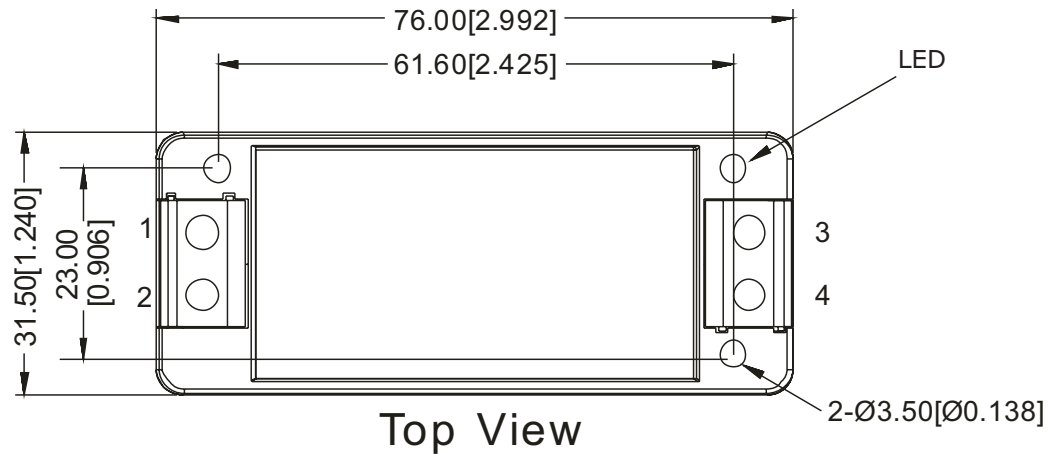

## TYPICAL APPLICATION CIRCUIT

Figure 1

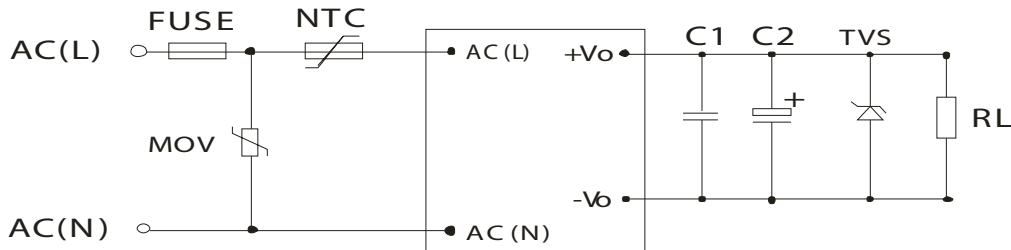

Table 1

Recommended External Circuit Components						
MODEL	C1 <sup>1</sup>	C2 <sup>1</sup>	TVS	FUSE	MOV	NTC
VSK-S10-3R3UA-T	1 $\mu$ F/50V	220 $\mu$ F/10V	SMBJ7.0A	2A/250V	S14K300	10D-10
VSK-S10-5UA-T	1 $\mu$ F/50V	220 $\mu$ F/10V	SMBJ7.0A	2A/250V	S14K300	10D-10
VSK-S10-9UA-T	1 $\mu$ F/50V	120 $\mu$ F/25V	SMBJ12A	2A/250V	S14K300	10D-10
VSK-S10-12UA-T	1 $\mu$ F/50V	120 $\mu$ F/25V	SMBJ20A	2A/250V	S14K300	10D-10
VSK-S10-15UA-T	1 $\mu$ F/50V	120 $\mu$ F/25V	SMBJ20A	2A/250V	S14K300	10D-10
VSK-S10-24UA-T	1 $\mu$ F/50V	68 $\mu$ F/35V	SMBJ30A	2A/250V	S14K300	10D-10

Note: 1. Output filtering capacitor C1 is a ceramic capacitor that is used to filter high frequency noise. C2 is an electrolytic capacitor. It is recommended to use high frequency and low impedance electrolytic capacitors. For capacitance and current of capacitor please refer to the manufacturer's datasheet. Voltage derating of capacitor should be 80% or above.

## EMC RECOMMENDED CIRCUIT

Figure 2

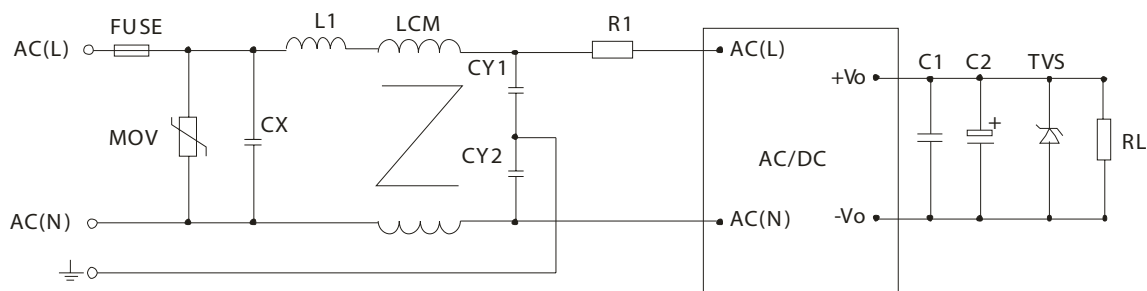

Table 2

Recommended External Circuit Components								
FUSE	MOV	CY1, CY2	CX	LCM	L1	R1	C1, C2,	TVS
2A/250 Vdc slow fusing	S14K300	1nF/400VAC	0.1 $\mu$ F/275VAC	2.2mH	4.7 $\mu$ H/2.0A	12 $\Omega$ /3W	see Table 1	see Table 1

Note: 1. All specifications measured at Ta=25°C, humidity <75%, nominal Vac input voltage, and rated output load, unless otherwise specified.

## REVISION HISTORY

---

rev.	description	date
1.0	initial release	09/06/2012
1.01	updated mechanical drawing and product photo	11/28/2012
1.02	updated spec	03/08/2013
1.03	changed internal IC, updated datasheet	06/08/2015

The revision history provided is for informational purposes only and is believed to be accurate.



**Headquarters**  
20050 SW 112th Ave.  
Tualatin, OR 97062  
**800.275.4899**

Fax 503.612.2383  
**cui.com**  
techsupport@cui.com

CUI offers a two (2) year limited warranty. Complete warranty information is listed on our website.

CUI reserves the right to make changes to the product at any time without notice. Information provided by CUI is believed to be accurate and reliable. However, no responsibility is assumed by CUI for its use, nor for any infringements of patents or other rights of third parties which may result from its use.

CUI products are not authorized or warranted for use as critical components in equipment that requires an extremely high level of reliability. A critical component is any component of a life support device or system whose failure to perform can be reasonably expected to cause the failure of the life support device or system, or to affect its safety or effectiveness.