

D-SUB sleeve housings - VS-09-T-2M16 - 1688353

Please be informed that the data shown in this PDF Document is generated from our Online Catalog. Please find the complete data in the user's documentation. Our General Terms of Use for Downloads are valid (<http://phoenixcontact.com/download>)



D-SUB sleeve housing, shell size 1, IP67 degree of protection



Key Commercial Data

Packing unit	1 pc
Minimum order quantity	5 pc
Weight per Piece (excluding packing)	39.6 g
Custom tariff number	85472000
Country of origin	Germany

Technical data

Mechanical characteristics

Insertion/withdrawal cycles	≥ 1000
External cable diameter	3 mm ... 9 mm
Cable exit	Angled
Color	gray

Ambient conditions

Ambient temperature (operation)	-40 °C ... 80 °C
---------------------------------	------------------

Material data

Flammability rating according to UL 94	V0
Housing material	PA

Electrical characteristics

Degree of pollution	2
---------------------	---

Standards and Regulations

D-SUB sleeve housings - VS-09-T-2M16 - 1688353

Technical data

Standards and Regulations

Flammability rating according to UL 94	V0
--	----

Classifications

eCl@ss

eCl@ss 4.0	27140816
eCl@ss 4.1	27260701
eCl@ss 5.0	27260701
eCl@ss 5.1	27260701
eCl@ss 6.0	27261203
eCl@ss 7.0	27440202
eCl@ss 8.0	27440202
eCl@ss 9.0	27440202

ETIM

ETIM 2.0	EC000437
ETIM 3.0	EC000437
ETIM 4.0	EC000437
ETIM 5.0	EC000437

UNSPSC

UNSPSC 6.01	31261501
UNSPSC 7.0901	31261501
UNSPSC 11	31261501
UNSPSC 12.01	31261501
UNSPSC 13.2	31261501

Approvals

Approvals

Approvals

EAC

Ex Approvals

D-SUB sleeve housings - VS-09-T-2M16 - 1688353

Approvals

Approvals submitted

Approval details

EAC

Drawings

Dimensional drawing

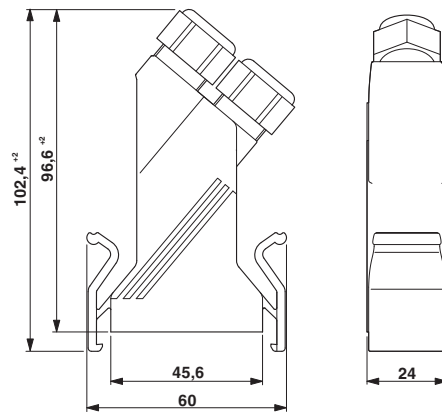

D-SUB sleeve housings