

2.5 A Output Current IGBT and MOSFET Driver



23052



FEATURES

- 2.5 A minimum peak output current
- Rail-to-rail output stage
- 0.5 μ s maximum propagation delay time
- 35 kV/ μ s minimum common mode rejection (CMR) at $V_{CM} = 1500$ V
- Wide operating V_{CC} range: 15 V to 30 V
- $I_{CC} = 3.5$ mA maximum supply current
- Industrial temperature range: -40 °C to $+105$ °C
- Under voltage lock-out (UVLO) with hysteresis
- Material categorization: for definitions of compliance please see www.vishay.com/doc?99912

RoHS
COMPLIANT

APPLICATIONS

- Isolated IGBT / MOSFET gate driver
- AC and brushless DC motor drives
- Induction stove top
- Industrial inverters
- Switch mode power supplies (SMPS)
- Uninterruptible power supplies (UPS)

AGENCY APPROVALS

- [UL 1577](#)
- [cUL](#)
- [DIN EN 60747-5-5 \(VDE 0884\) and reinforced insulation rating available with option "V"](#)
- [CQC](#)

DESIGN SUPPORT TOOLS

[click logo to get started](#)

DESCRIPTION

The VOD3120A consists of a AlGaAs LED optically coupled to an integrated circuit with a power output stage. This optocoupler is ideally suited for driving power IGBTs and MOSFETs used in motor control inverter applications. The high operating voltage range of the output stage provides the drive voltages required by gate controlled devices. The voltage and current supplied by this optocoupler makes it ideally suited for directly driving IGBTs with ratings up to 1200 V / 100 A. For IGBTs with higher ratings, the VOD3120A can be used to drive a discrete power stage which drives the IGBT gate.

ORDERING INFORMATION

V	O	D	3	1	2	0	A	#	-	V	T	#
PART NUMBER								PACKAGE OPTION	VDE OPTION	TAPE AND REEL		

AGENCY CERTIFIED / PACKAGE	CMR (kV/ μ s)
UL, cUL, CQC	35
DIP-8	VOD3120AD
DIP-8, 400 mil	VOD3120AG
SMD-8	VOD3120AB-T
SMD-8, 180° orientation	VOD3120AB-T2
VDE, UL, cUL, CQC	35
DIP-8	VOD3120AD-V
DIP-8, 400 mil	VOD3120AG-V
SMD-8	VOD3120AB-VT
SMD-8, 180° orientation	VOD3120AB-VT2



TRUTH TABLE			
LED	HIGH SIDE	LOW SIDE	V_O
Off	Off	On	Low
On	On	Off	High

ABSOLUTE MAXIMUM RATINGS (T _{amb} = 25 °C, unless otherwise specified)				
PARAMETER	TEST CONDITION	SYMBOL	VALUE	UNIT
INPUT				
Forward current		I _F	20	mA
Peak transient input current	≤ 1 μs pulse width, 300 pps	I _{F(TRAN)}	1	A
Reverse input voltage		V _R	5	V
Input current (rise / fall time) ⁽¹⁾		t _{r(in)} / t _{f(in)}	500	ns
Output power dissipation		P _{diss}	45	mW
OUTPUT				
High peak output current ⁽²⁾		I _{OH(PEAK)}	2.5	A
Low peak output current ⁽²⁾		I _{OL(PEAK)}	2.5	A
Supply voltage		(V _{CC} - V _{EE})	0 to +35	V
Output voltage		V _{O(PEAK)}	35	V
Output power dissipation		P _{diss}	250	mW
Junction temperature		T _j	125	°C
OPTOCOUPLER				
Storage temperature range		T _S	-55 to +125	°C
Ambient operating temperature range		T _{amb}	-40 to +105	°C
Total power dissipation		P _{tot}	295	mW
Soldering temperature		T _{sld}	260	°C

Notes

- Stresses in excess of the absolute maximum ratings can cause permanent damage to the device. Functional operation of the device is not implied at these or any other conditions in excess of those given in the operational sections of this document. Exposure to absolute maximum ratings for extended periods of the time can adversely affect reliability

⁽¹⁾ The rise and fall times of the forward current should be less than 500 ns

⁽²⁾ Exponential waveform, pulse width ≤ 0.3 μs, f ≤ 15 kHz

RECOMMENDED OPERATING CONDITION				
PARAMETER	SYMBOL	MIN.	MAX.	UNIT
Operating temperature	T _{amb}	-40	+105	°C
Power supply voltage	V _{CC} - V _{EE}	15	30	V
Forward current (V _O in "high" state)	I _{F(ON)}	7	16	mA
Forward voltage (V _O in "low" state)	V _{F(OFF)}	0	0.8	V

ELECTRICAL CHARACTERISTICS ($T_{amb} = 25\text{ }^{\circ}\text{C}$, unless otherwise specified)						
PARAMETER	TEST CONDITION	SYMBOL	MIN.	TYP.	MAX.	UNIT
INPUT						
Forward voltage	$I_F = 10\text{ mA}$	V_F	1.2	1.37	1.8	V
Temperature coefficient of forward voltage	$I_F = 10\text{ mA}$	$\Delta V_F / \Delta T$	-	-1.237	-	mV/ $^{\circ}\text{C}$
Reverse breakdown voltage	$I_R = 10\text{ }\mu\text{A}$	BV_R	5	-	-	V
Threshold forward current (V_O from "low" to "high")	$V_{CC} = 30\text{ V}$, $V_O < 5\text{ V}$	I_{FLH}	-	1.8	5	mA
Threshold forward voltage (V_O from "high" to "low")	$V_{CC} = 30\text{ V}$, $V_O > 5\text{ V}$	V_{FLH}	0.8	-	-	V
Input capacitance	$f = 1\text{ MHz}$, $V_F = 0\text{ V}$	C_{IN}	-	33	-	pF
OUTPUT						
High level supply current	$I_F = 10\text{ mA}$, $V_{CC} = 30\text{ V}$, $V_O = \text{open}$	I_{CCH}	-	2.4	3.5	mA
Low level supply current	$I_F = 0\text{ mA}$, $V_{CC} = 30\text{ V}$, $V_O = \text{open}$	I_{CCL}	-	2.5	3.5	mA
High level output current	$V_O = (V_{CC} - 1.5\text{ V})$	$I_{OH}^{(1)}$	-	-	-1.0	A
	$V_O = (V_{CC} - 4\text{ V})$	$I_{OH}^{(2)}$	-	-	-2.5	A
Low level output current	$V_O = (V_{EE} + 1.5\text{ V})$	$I_{OL}^{(1)}$	1.0	-	-	A
	$V_O = (V_{EE} + 4\text{ V})$	$I_{OL}^{(2)}$	2.5	-	-	A
High level output voltage	$I_F = 10\text{ mA}$, $I_O = -100\text{ mA}$	V_{OH}	$V_{CC} - 0.3\text{ V}$	$V_{CC} - 0.1\text{ V}$	-	V
Low level output voltage	$I_F = 0\text{ mA}$, $I_O = 100\text{ mA}$	V_{OL}	-	$V_{EE} + 0.1\text{ V}$	$V_{EE} + 0.25\text{ V}$	V
UVLO threshold	$V_O > 5\text{ V}$, $I_F = 10\text{ mA}$	V_{UVLO+}	11.0	12.7	13.5	V
	$V_O < 5\text{ V}$, $I_F = 10\text{ mA}$	V_{UVLO-}	9.5	11.2	12.0	V
UVLO hysteresis		$UVLO_{HYS}$	-	1.5	-	V
COUPLER						
Coupling capacitance	$f = 1\text{ MHz}$	C_{IO}	-	0.92	-	pF

Notes

- All typical values at $T_{amb} = 25\text{ }^{\circ}\text{C}$ and $V_{CC} - V_{EE} = 30\text{ V}$, unless otherwise specified; all minimum and maximum specifications are at recommended operating condition
- (1) Maximum pulse width = 50 μs
- (2) Maximum pulse width = 10 μs

TEST CIRCUITS

 Fig. 1 - I_{FLH} Test Circuit

Fig. 2 - UVLO Test Circuit

SWITCHING CHARACTERISTICS ($T_{amb} = 25\text{ }^{\circ}\text{C}$, $V_{CC} - V_{EE} = 30\text{ V}$ unless otherwise specified)						
PARAMETER	TEST CONDITION	SYMBOL	MIN.	TYP.	MAX.	UNIT
Propagation delay time to $V_O = \text{"low"}$	$R_g = 10\ \Omega$, $C_g = 25\text{ nF}$, $f = 10\text{ kHz}$, duty cycle = 50 %, $I_F = 7\text{ mA to } 16\text{ mA}$, $V_{CC} = 10\text{ V to } 30\text{ V}$, $V_{EE} = \text{ground}$	t_{PHL}	0.05	0.13	0.5	μs
Propagation delay time to $V_O = \text{"high"}$		t_{PLH}	0.05	0.13	0.5	μs
Pulse width distortion		PWD	-	0.005	0.07	μs
Propagation delay difference ⁽¹⁾		PDD	-0.1	-	0.1	μs
Output rise time (10 % to 90 %)		t_r	-	0.035	-	μs
Output fall time (90 % to 10 %)		t_f	-	0.035	-	μs

Note

⁽¹⁾ The difference between t_{PHL} and t_{PLH} between any two parts, series parts, or channels under same test conditions

 Fig. 3 - t_{PLH} , t_{PHL} , t_r and t_f Test Circuit and Waveforms

COMMON MODE TRANSIENT IMMUNITY ($T_{amb} = 25\text{ }^{\circ}\text{C}$, $V_{CC} - V_{EE} = 30\text{ V}$ unless otherwise specified)						
PARAMETER	TEST CONDITION	SYMBOL	MIN.	TYP.	MAX.	UNIT
Common mode transient immunity at high level output ($V_O = \text{"high"}$) ⁽¹⁾	$I_F = 10\text{ mA to } 16\text{ mA}$, $V_{CM} = 1500\text{ V}$, $V_{CC} = 30\text{ V}$	$ CM_H $	35	50	-	$\text{kV}/\mu\text{s}$
Common mode transient immunity at low level output ($V_O = \text{"low"}$) ⁽²⁾	$V_F = 0\text{ V}$, $V_{CM} = 1500\text{ V}$, $V_{CC} = 30\text{ V}$	$ CM_L $	35	50	-	$\text{kV}/\mu\text{s}$

Notes

⁽¹⁾ CM_H is the maximum rate of rise of the common mode voltage that can be sustained with the output voltage in the logic high state ($V_O > 15\text{ V}$)

⁽²⁾ CM_L is the maximum rate of fall of the common mode voltage that can be sustained with the output voltage in the logic low state ($V_O < 1\text{ V}$)



Fig. 4 - CMR Test Circuit and Waveforms



SAFETY AND INSULATION RATINGS ($T_{amb} = 25\text{ }^{\circ}\text{C}$, unless otherwise specified)				
PARAMETER	TEST CONDITION	SYMBOL	VALUE	UNIT
Comparative tracking index	Insulation group IIIa	CTI	175	
Maximum rated withstanding isolation voltage	According to UL1577, $t = 1\text{ min}$	V_{ISO}	5300	V_{RMS}
Maximum transient isolation voltage	According to DIN EN 60747-5-5	V_{IOTM}	6000	V_{peak}
Maximum repetitive peak isolation voltage	According to DIN EN 60747-5-5	V_{IORM}	891	V_{peak}
Isolation resistance	$T_{amb} = 25\text{ }^{\circ}\text{C}$, $V_{IO} = 500\text{ V}$	R_{IO}	10^{12}	Ω
	$T_{amb} = 100\text{ }^{\circ}\text{C}$, $V_{IO} = 500\text{ V}$	R_{IO}	10^{11}	Ω
Output safety power		P_{SO}	250	mW
Input safety current		I_{SI}	25	mA
Input safety temperature		T_S	175	$^{\circ}\text{C}$
Creepage distance			> 7	mm
Clearance distance			> 7	mm
Insulation thickness		DTI	> 0.4	mm

Note

- As per IEC 60747-5-2, §7.4.3.8.1, this optocoupler is reinforced rated and suitable for “safe electrical insulation” only within the safety ratings. Compliance with the safety ratings shall be ensured by means of protective circuits

TYPICAL CHARACTERISTICS ($T_{amb} = 25\text{ }^{\circ}\text{C}$, unless otherwise specified)



Fig. 5 - Forward Current vs. Forward Voltage

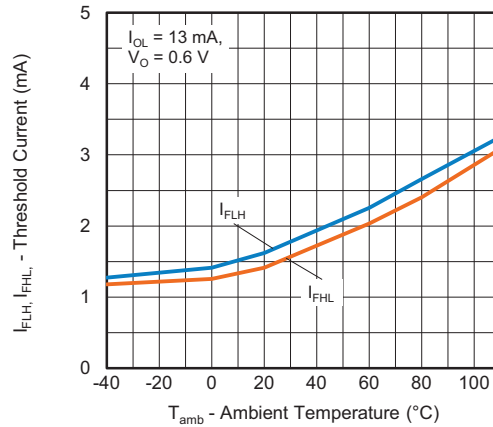

Fig. 7 - Threshold Current vs. Ambient Temperature



Fig. 6 - Output Voltage vs. Forward Current

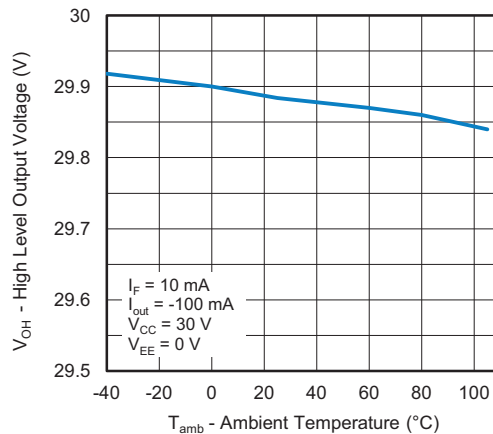

Fig. 8 - High Level Output Voltage vs. Ambient Temperature

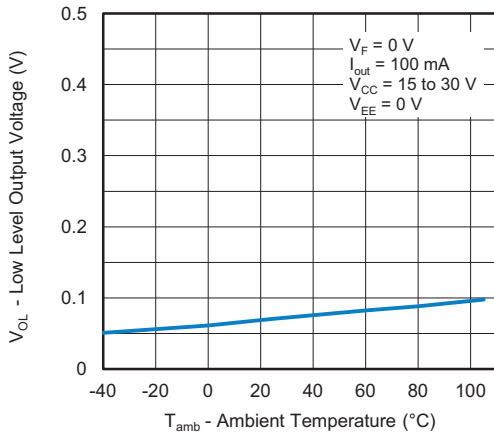

Fig. 9 - Low Level Output Voltage vs. Ambient Temperature

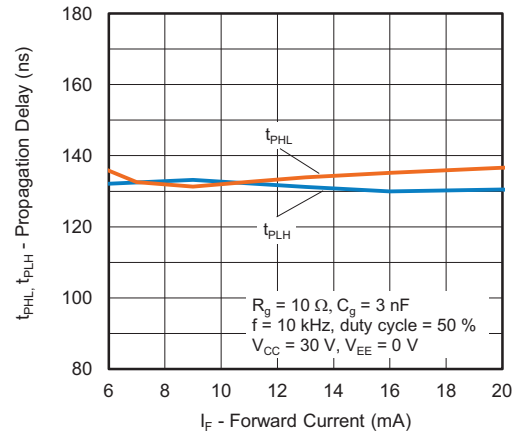

Fig. 12 - Propagation Delay vs. Forward Current

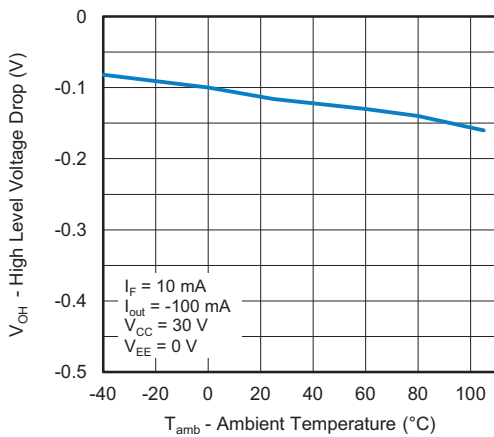

Fig. 10 - High Level Voltage Drop vs. Ambient Temperature

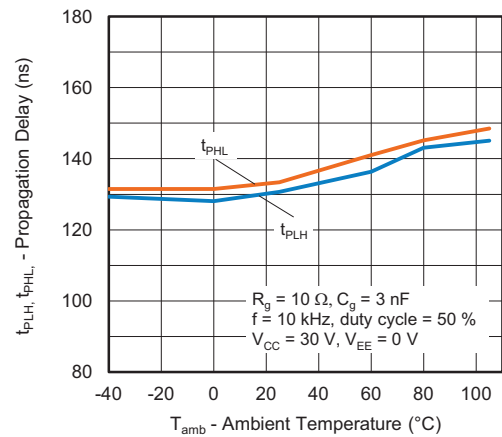

Fig. 13 - Propagation Delay vs. Ambient Temperature



Fig. 11 - Low Level Voltage Drop vs. Ambient Temperature

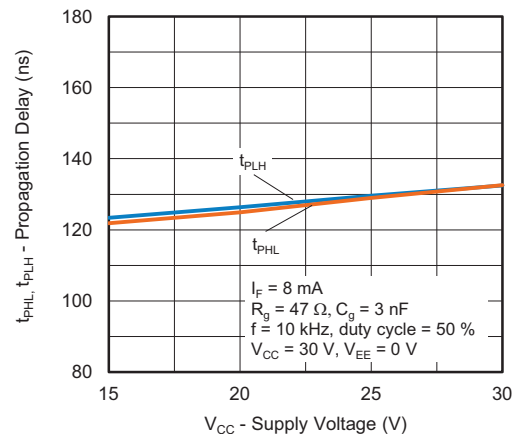

Fig. 14 - Propagation Delay vs. Supply Voltage



Fig. 15 - Propagation Delay vs. Load Resistance

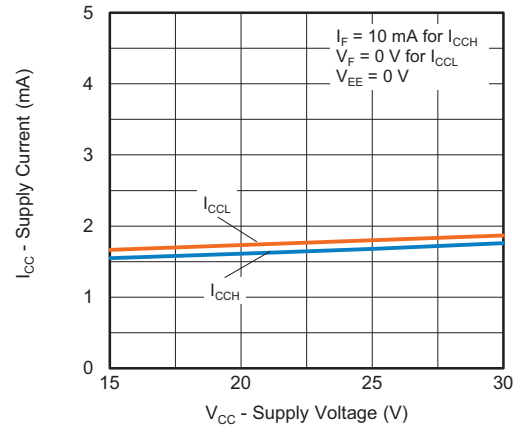

Fig. 17 - Supply Current vs. Supply Voltage

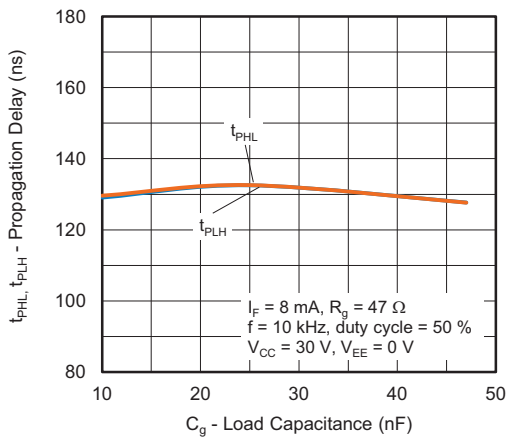

Fig. 16 - Propagation Delay vs. Load Capacitance



Fig. 18 - Supply Current vs. Ambient Temperature



PACKAGE DIMENSIONS (in millimeters)

DIP-8



Fig. 19

DIP-8, 400 mil



Fig. 20

SMD-8

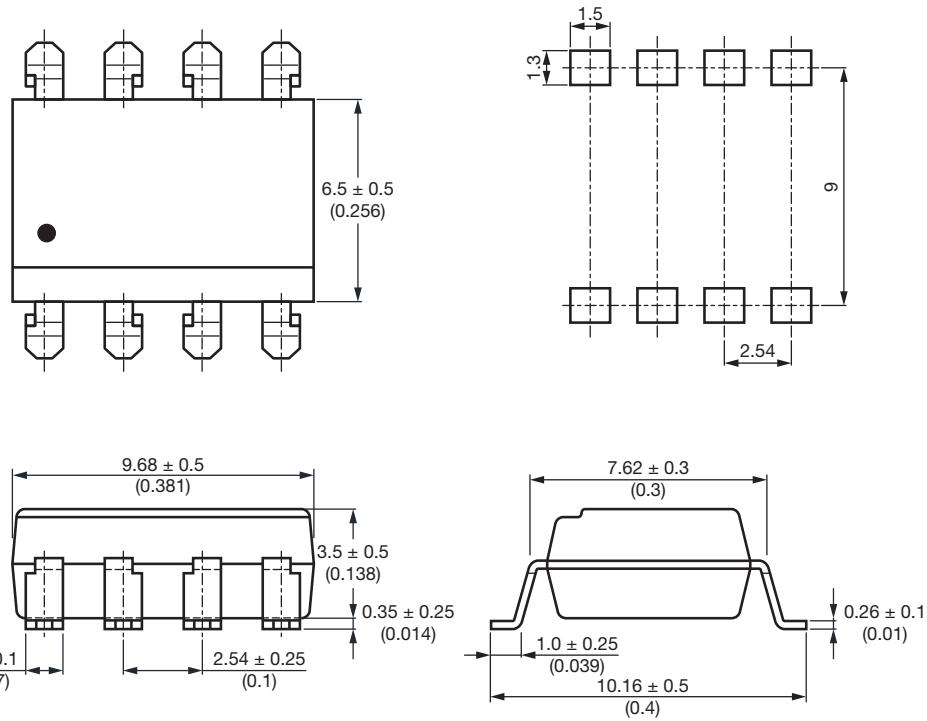

Fig. 21

PACKAGE MARKING



Fig. 22 - Example of VOD3120AB-VT

Notes

- "X" is only marked on VDE option parts
- Tape and reel suffix (T) is not part of the package marking



PACKAGING INFORMATION (in millimeters)

DEVICES PER TUBES			
TYPE	UNITS/TUBE	TUBES/BOX	UNITS/BOX
DIP-8	50	40	4
DIP-8, 400 mil	50	40	4

SMD-8 Tape

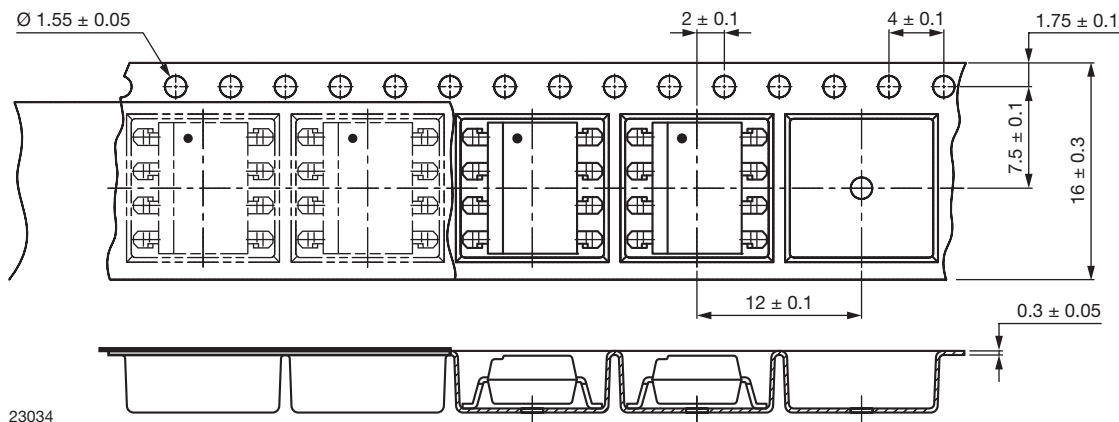

Fig. 23 - Tape and Reel Packaging (1000 pieces on reel)

SMD-8 Tape, 180° Orientation

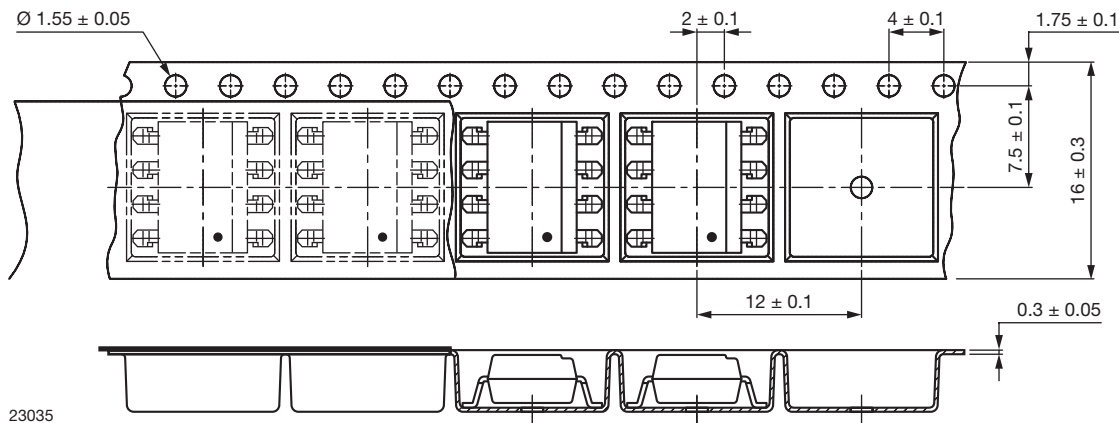

Fig. 24 - Tape and Reel Packaging (1000 pieces on reel)



Reel



Fig. 25 - Tape and Reel Shipping Medium

SOLDER PROFILES
IR Reflow Soldering (JEDEC® J-STD-020C compliant)

One time soldering reflow is recommended within the condition of temperature and time profile shown below. Do not solder more than three times.

PROFILE ITEM	CONDITIONS
Preheat	
- Temperature minimum ($T_{S \text{ min.}}$)	150 °C
- Temperature maximum ($T_{S \text{ max.}}$)	200 °C
- Time (min. to max.) (t_S)	90 s ± 30 s
Soldering zone	
- Temperature (T_L)	217 °C
- Time (t_L)	60 s
Peak temperature (T_p)	260 °C
Ramp-up rate	3 °C/s max.
Ramp-down rate	3 °C/s to 6 °C/s

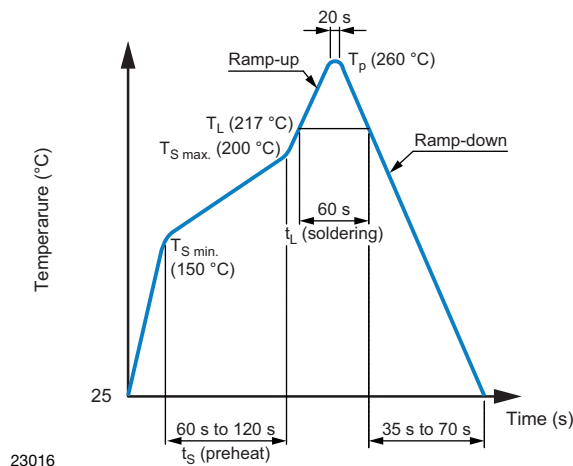

Fig. 1

Wave Soldering (JEDEC JESD22-A111 compliant)

One time soldering is recommended within the condition of temperature.

Temperature: 260 °C + 0 °C / - 5 °C

Time: 10 s

Preheat temperature: 25 °C to 140 °C

Preheat time: 30 s to 80 s



Fig. 2

23017

Hand Soldering by Soldering Iron

Allow single lead soldering in every single process. One time soldering is recommended.

Temperature: 380 °C + 0 °C / - 5 °C

Time: 3 s max.

HANDLING AND STORAGE CONDITIONS

ESD level: HBM class 2

Floor life: unlimited

Conditions: $T_{\text{amb}} < 30 \text{ °C}$, RH < 85 %

Moisture sensitivity level 1, according to J-STD-020



Disclaimer

ALL PRODUCT, PRODUCT SPECIFICATIONS AND DATA ARE SUBJECT TO CHANGE WITHOUT NOTICE TO IMPROVE RELIABILITY, FUNCTION OR DESIGN OR OTHERWISE.

Vishay Intertechnology, Inc., its affiliates, agents, and employees, and all persons acting on its or their behalf (collectively, "Vishay"), disclaim any and all liability for any errors, inaccuracies or incompleteness contained in any datasheet or in any other disclosure relating to any product.

Vishay makes no warranty, representation or guarantee regarding the suitability of the products for any particular purpose or the continuing production of any product. To the maximum extent permitted by applicable law, Vishay disclaims (i) any and all liability arising out of the application or use of any product, (ii) any and all liability, including without limitation special, consequential or incidental damages, and (iii) any and all implied warranties, including warranties of fitness for particular purpose, non-infringement and merchantability.

Statements regarding the suitability of products for certain types of applications are based on Vishay's knowledge of typical requirements that are often placed on Vishay products in generic applications. Such statements are not binding statements about the suitability of products for a particular application. It is the customer's responsibility to validate that a particular product with the properties described in the product specification is suitable for use in a particular application. Parameters provided in datasheets and / or specifications may vary in different applications and performance may vary over time. All operating parameters, including typical parameters, must be validated for each customer application by the customer's technical experts. Product specifications do not expand or otherwise modify Vishay's terms and conditions of purchase, including but not limited to the warranty expressed therein.

Except as expressly indicated in writing, Vishay products are not designed for use in medical, life-saving, or life-sustaining applications or for any other application in which the failure of the Vishay product could result in personal injury or death. Customers using or selling Vishay products not expressly indicated for use in such applications do so at their own risk. Please contact authorized Vishay personnel to obtain written terms and conditions regarding products designed for such applications.

No license, express or implied, by estoppel or otherwise, to any intellectual property rights is granted by this document or by any conduct of Vishay. Product names and markings noted herein may be trademarks of their respective owners.