

V-Series

Contura IV, V, VII Switches

The V-Series Contura IV, V, & VII snap-in rocker switches offer countless unique options including choices for ratings, circuits, colors, illuminations and symbols. These single or double pole switches feature removable actuators in a choice of actuator styles and colors, and can be illuminated with either oval or bar shaped lenses. Actuators may also be purchased and stocked separately. An optional plug-in terminal connector enables pre-wiring of wire harnesses.

The Contura switches with sealed option, are certified to IP66 and IP68, signifying complete protection against dust and prolonged spray and submersion under pressure, and are recognized to UL1500 - Ignition Protection for Marine Products. These switches are vibration, shock, thermoshock, moisture and salt spray resistant. Temperature ratings range from -40°C to +85°C.

Resources:

[Download 3D CAD Files](#)



[Watch Product Video](#)



Contura V



Contura IV



Contura VII

Product Highlights:

- ♦ Countless options for ratings, circuits, colors, illuminations and legends
- ♦ Certified to IP66 and IP68 for front panel components
- ♦ Vibration, shock, thermoshock, moisture and salt spray resistant
- ♦ Temperature range from -40°C to +85°C.

Typical Applications:

- ♦ On/Off Highway Equipment
- ♦ Marine
- ♦ Military Armored Vehicles
- ♦ Mining Machinery and Equipment
- ♦ Any application requiring environmental protection



Carling Technologies™

Innovative Designs. Powerful Solutions.

Carling Technologies, Inc.
60 Johnson Avenue, Plainville, CT 06062
Email: sales@carlingtech.com
Application Support: team2@carlingtech.com
Phone: (860) 793-9281 • Fax: (860) 793-9231
www.carlingtech.com

V-Series Switch

DESIGN FEATURES

INTERCHANGEABLE ACTUATORS

Panel redesign is a snap with our wide range of rocker styles. Achieve maximum design variety with minimum inventory. Simply swap rockers to create an entirely new look for your panel.

DUAL SEAL PROTECTION

Seals out water, dust, and debris, and enables switch certification to IP66/IP68 for front panel components.

CLEAN CONNECTIONS

Options for both eight and ten terminal base styles with AMP & Packard compatible connectors affords myriad circuit options while providing ease of assembly.

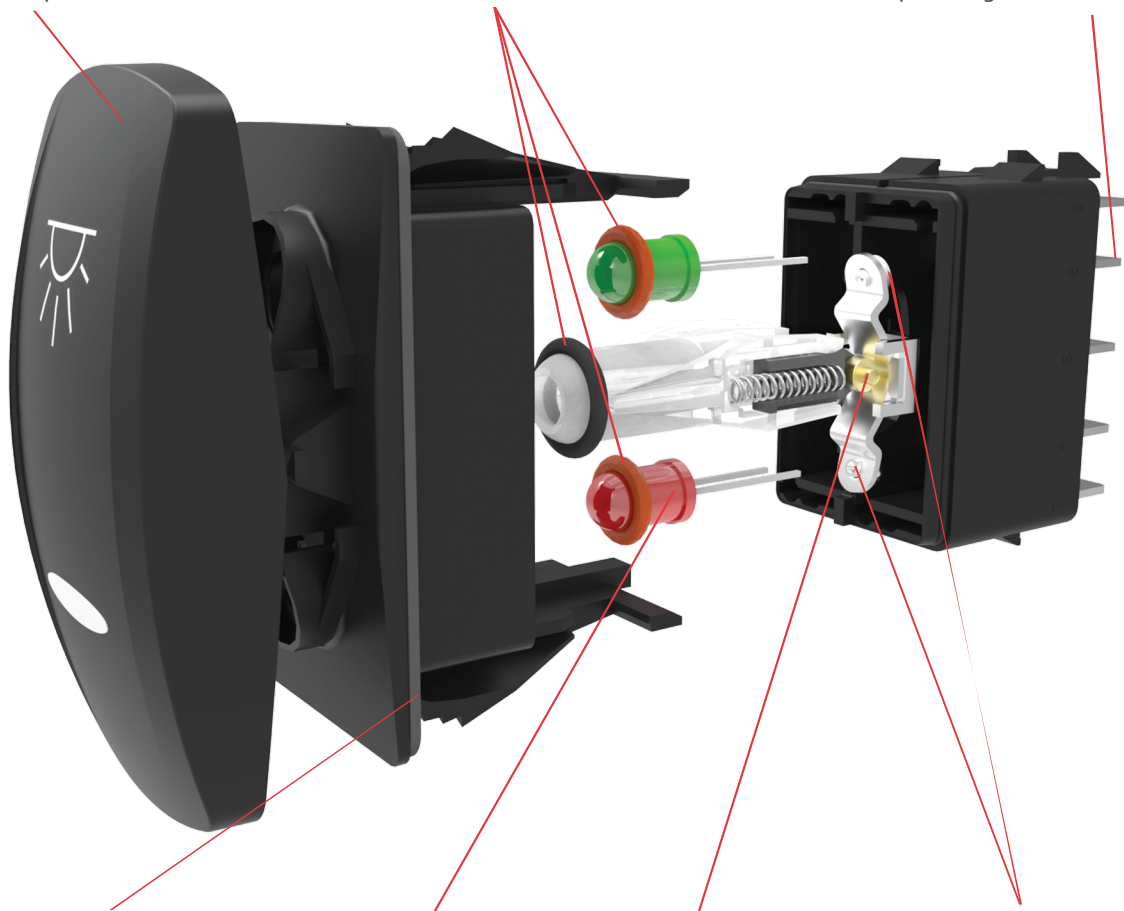

OPTIONAL PANEL SEAL

Prevents water/dust ingress behind panel.

MULTIPLE LIGHTING OPTIONS

In addition to incandescent lamps, our LED illumination is offered in a wide array of light intensities, colors, as well as dual level, tri-color, and flashing options.

BRASS ROLLER PIN

Robust mechanism eliminates the need for lubricants. Enables switch to withstand -40°C to +85°C temperatures.

SILVER PLATED BUTT CONTACT MECHANISM

Providing 50K to 100K electrical cycles and a variety of different electrical ratings.

Electrical

Contact Rating	.4VA @ 24VDC (MAX) resistive 15 amps, 125VAC 10 amps, 250VAC 1/2 HP 125-250VAC 20 amps, 4-14VDC 15 amps, 15-28VDC 10A, 14VT 6A, 125VAC L
Dielectric Strength	1500 Volts RMS
Insulation Resistance	50 Megohms
Initial Contact Resistance	10 milliohms max. @ 4VDC
Life	50,000- 100,000 cycles circuit dependent
Contacts	Silver alloy, silver tin-oxide, fine silver
Terminals	Brass or copper/silver plate 1/4" (6.3mm) Quick Connect terminations standard. Solder lug, Wire Lead

Mechanical

Endurance	150,000 cycles minimum circuit dependent
-----------	--

Physical

Lighted	Incandescent - rated 10,000 hours Neon - rated 25,000 hours LED - rated 100,000 hours 1/2 life (LED is internally ballasted for voltages to 24VDC)
Seals	Internal
Base	Optional external gasket panel seal Polyester blend rated to 125°C with a UL flammability rating of 94V0.
Contura II,III,IV,V, VI, VII Actuator	Hard Surface: Basic actuator structure molded of thermoplastic polycarbonate with a hard Nylon 66 thermoplastic surface overlay. Soft Surface: Basic actuator structure molded of thermoplastic polycarbonate with an elastomer overlay.
Contura X,XI,XII Actuator,VP	Nylon 66 Reinforced rated to 105°C
Lens	Polycarbonate rated at 100°C
Contura XIV	Polycarbonate lens/subrocker with ABS shell

Actuator Travel (Angular Displacement)

2 position	18°
3 positions	9° from center

Mounting Specifications

Panel Thickness Range	
Gaskets Acceptable Panel Thickness	
0	.030 to .250 (.76mm to 6.35mm)
1	.030 to .109 & .147 to .157 (.76 to 2.77mm & 3.73 to 3.98mm)
Recommended: No gasket with panel thickness of .032, .062, .093, .125, .187 or .250	

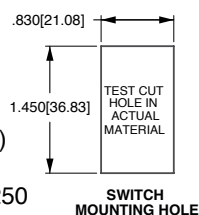

Agency Certifications



Environmental

Sealing	Sealed version: IP68, in accordance with IEC 60529, BS 5490, DIN 40050 & NFC 20 010. This rating applies to front panel components of the actual switch only, and signifies protection against dust and the prolonged effects of immersion under pressure. The standard test for immersion under pressure requires submersion under one meter of water for 30 min. The V-Series switch has exceeded these parameters, having been actuated and illuminated during submersion.
Corrosion	Mixed Flowing Gas (MFG) Class III 3 year accelerated exposure per ASTM B-827, B-845 Silver and gold contacts
Operating Temp.	-40°C to +85°C
Vibration 1	Per Mil-Std 202F, Method 204D Test Condition A 0.06 DA or 10G's 10-500 Hz. Tested with VCH connector. Test criteria - No loss of circuit during test, pre and post test contact resistance.
Vibration 2	Resonance search 24-50 Hz 0.40 DA 50-2000 Hz ±10 G's peak Horizontal Axis 3-5 G's max. Random 24 Hz 0.06 PSD-Gsq/Hz 60 Hz 0.50 100 Hz 0.50 200 Hz 0.025 2000 Hz 0.025 No loss of circuit during test; <10µ seconds chatter.
Shock	Per Mil-Std 202F, Method 213B, Test Condition K @ 30G's. Tested with VCH connector. Test criteria - No loss of circuit during test, pre and post test contact resistance.
Salt Spray	Per Mil-Std 202F, Method 101D, Test Condition A, 96 Hrs. Sealed version only.
Dust	Per Mil-Std 810C, Method 510.2 Air Velocity 300 ±200 Feet/Min, Test Duration 16 Hrs.
Thermal Shock	Per Mil-Std 202F, Method 107F, Test Cond. A, -55°C to +85°C. Test criteria - pre and post test contact resistance
Moisture Resistance	Per Mil-Std 202F, Method 106F, Test Criteria - pre and post test contact resistance
Ignition Protection	All Contura switches with sealed construction meet the requirements of UL1500/ISO8846 for ignition protection, in addition to conformance with EC directive 94/25/EC for marine products.

Dimensional Specifications: in. [mm]

CONTURA IV

SHOWN WITH
BAR LENS

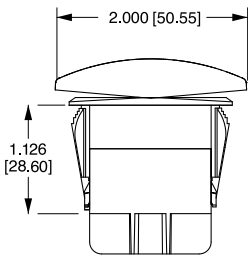
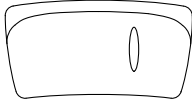

**10 TERMINAL BASE
W/O BARRIERS**

CONTURA V

SHOWN WITH
BAR LENS

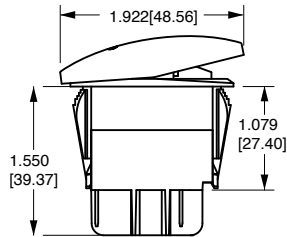
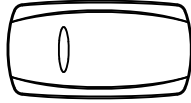

**8 TERMINAL BASE
W/BARRIERS**

CONTURA V

SHOWN WITH
LOW PROFILE LOCK

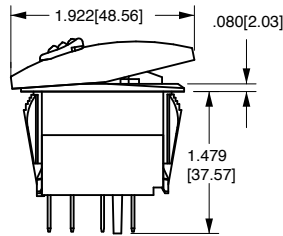
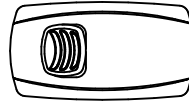

**8 TERMINAL BASE
W/O BARRIERS**

CONTURA VII

SHOWN WITH LARGE LENS
AND BAR LENS

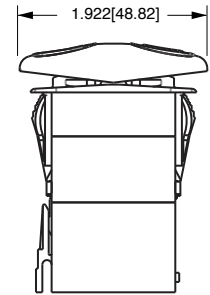
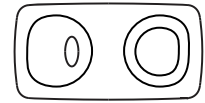

**10 TERMINAL BASE
W/O BARRIERS**

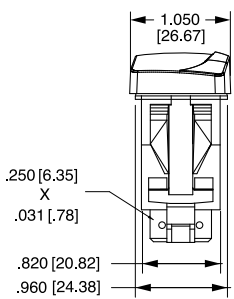

**10 TERMINAL BASE
W/O BARRIERS**

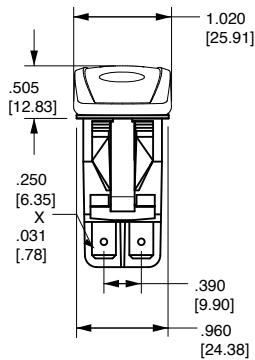

**8 TERMINAL BASE
W/BARRIERS**

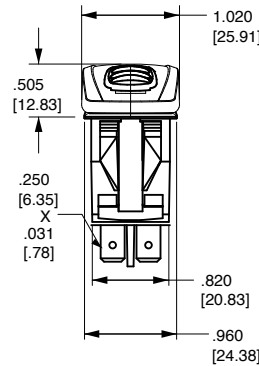

**8 TERMINAL BASE
W/O BARRIERS**

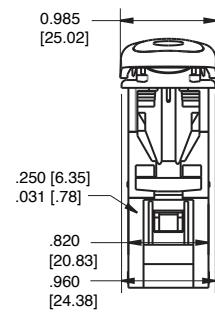

**10 TERMINAL BASE
W/O BARRIERS**

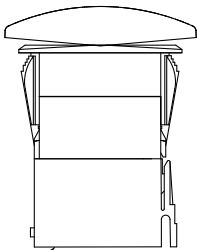

**SWITCH SHOWN
WITH VC1
CONNECTOR 10
TERMINAL**

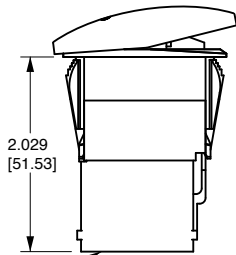

2.029
[51.53]

**SWITCH SHOWN
WITH VCH
CONNECTOR 8
TERMINAL**

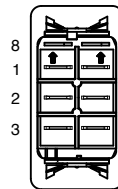

**BOTTOM VIEW
TERMINAL
ARRANGEMENT
8 TERMINAL BASE**

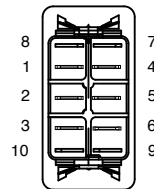

**BOTTOM VIEW
TERMINAL
ARRANGEMENT
10 TERMINAL BASE**

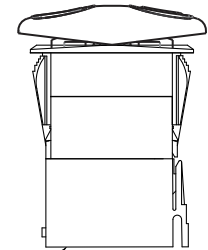

**SWITCH SHOWN
WITH VC1
CONNECTOR 10
TERMINAL**

CIRCUIT	CIRCUIT DIAGRAM
1	
2	
3	
4	
5	
6	
7	
8	

CIRCUIT	CIRCUIT DIAGRAM
A	
B	
C	
D	
E	
F	
G	
H	

CIRCUIT	CIRCUIT DIAGRAM
J	
K	
L	
M	
R	
S	

SYMBOL LEGEND	
SYM.	DEFINITION
	DESIGNATES TERMINALS AND CONTACTS
	DESIGNATES LAMP LOCATION
	DESIGNATES MAINTAINED CIRCUITS
	DESIGNATES OTHER POSITION
	DESIGNATES MOMENTARY CIRCUITS
	DESIGNATES TWO POSITION CONNECTION
	DESIGNATES EXTERNAL JUMPER PROVIDED BY CUSTOMER

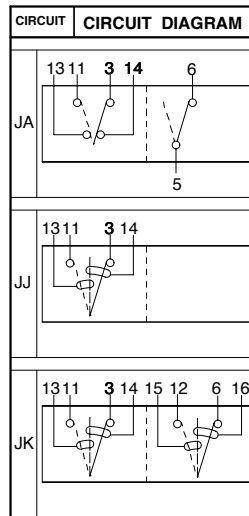
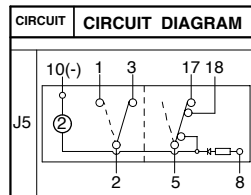
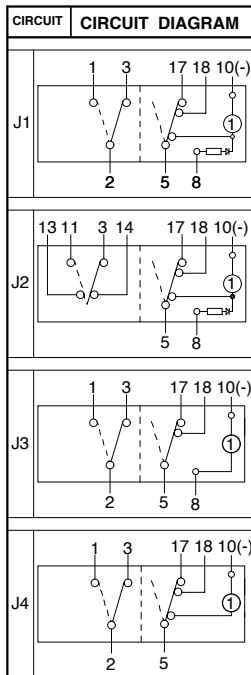
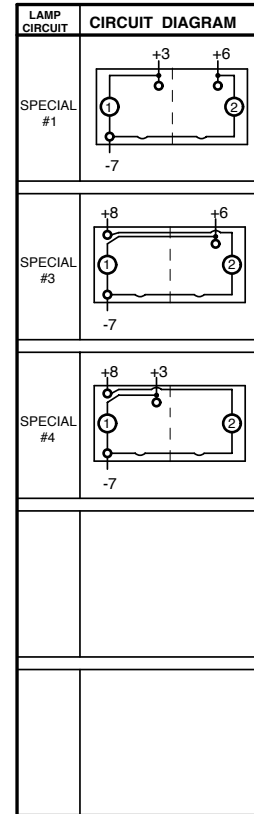
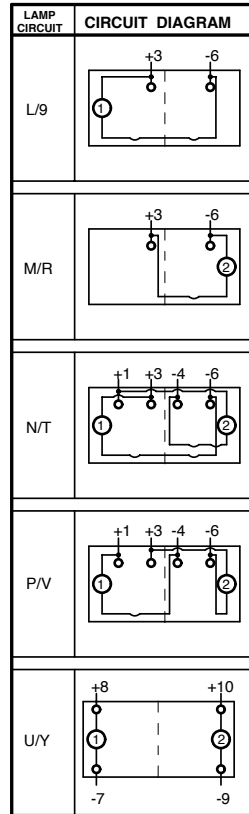
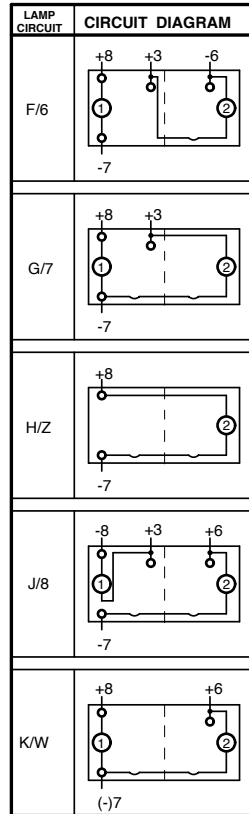
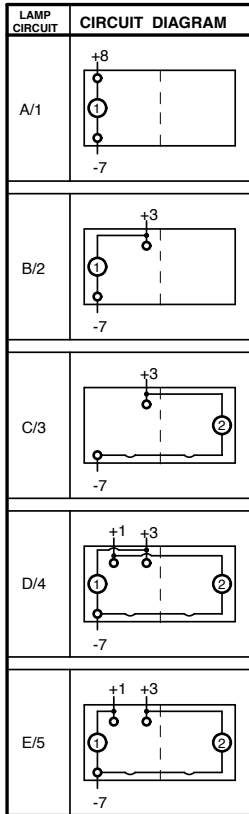

NOTE:
J circuits are available for all non-locking V-Series styles. Consult factory for p/n details.

SYMBOL LEGEND	
SYM.	DEFINITION
○	DESIGNATES TERMINALS AND CONTACTS
○	DESIGNATES LAMP LOCATION
○	DESIGNATES TWO POSITION CIRCUIT

CIRCUIT	CONNECTOR PART #
JA, JJ, JK	JC1-01
J1, J3, J4, J5	JC2-01
J2	JC3-01

V 1 D A B T O B - E P C 00 - 0 00

1 Series 2 Circuit 3 Rating 4 Termination Illumination 5 Lamp 6 Lamp 7 Lamp 8 Bracket 9 Actuator 10 Lens 11 Color 12 Legend 13 Legend Orientation 14 Actuator Lens Legend

1 SERIES

V

2 CIRCUIT

Terminal Connections as viewed from bottom of switch: () - momentary
 SP - single pole - uses terminals 1, 2 & 3.
 DP - double pole uses terminals 1, 2, 3, 4, 5 & 6.
 Terminals 7, 8, 9 & 10 for lamp circuit only.

Position:	1	2	3
SP DP	2 & 3, 5 & 6	Connected Terminals	1 & 2, 4 & 5
1 A	ON	NONE	OFF
2 B	(ON)	NONE	OFF
3 C	ON	NONE	(OFF)
4 D	ON	NONE	ON
5 F	ON	NONE	(ON)
6 J	ON	OFF	ON
7 K	ON	OFF	(ON)
8 L	(ON)	OFF	(ON)

SPECIAL CIRCUITS	2 & 3	2 & 3, 5 & 4	5 & 4
H*	2 & 3	2 & 3	5 & 4
G*	2 & 3, 5 & 6	2 & 3	OFF
S*	2 & 3, 5 & 6	2 & 3	1 & 2
M*	(2 & 3, 5 & 6)	2 & 3	OFF
R*	(2 & 3, 5 & 6)	2 & 3	2 & 1
E*	5 & 6	5 & 3	5 & 1

*Jumper between terminals 2 & 5 for circuits H, G, M, R & S are specified in selection 4. External jumper between terminals 2 & 4 for circuit E are provided by customer. Circuit E may be used for SP OFF-ON-ON circuit.

3 RATING⁴

- 1 .4VA @ 28VDC Resistive
- B 15A 24V
- C 20A 18V
- D 20A 12V
- E 20A 14V, 10A 14VT (circuit 1, 4, A & D only)
- F 10A 14V, 6A 14VT (circuit G only)
- M .4VA/20A 12V
- N .4VA/15A 24V

4 TERMINATION/BASE STYLE

8 term	10 Term	Termination	Jumper
1	2	.250 TAB (QC) no barriers	No
A	B	.250 TAB (QC) with barriers	No
J	K	.250 TAB (QC) no barriers	Yes T2 to 5
3	5	Solder Lug no barriers	No
C	D	Solder Lug	No
5	6	Wire Leads no barriers	No
E	F	Wire Leads	No

Note: Codes J & K for circuits H, G & M.

5 ILLUMINATION & SWITCH SEALING

Lamp #1: above terminals 1 & 4 end of switch.; Lamp #2 above terminals 3 & 6 end of switch. Positive (+) and negative (-) symbols apply to LED lamps only

Sealed	Unsealed	Lamps	Illumination Type	Lamp wired to Terminals
S	0	NONE	-	-
A	1	1	INDEPENDENT	8 (+) 7 (-)
B	2	1	DOWN	3 (+) 7 (-)
C	3	2	UP	3 (+) 7 (-)
D	4	1	DOWN	3 (+) 7 (-)
E	5	2	DOWN	1 (+) 7 (-)
F	6	1	UP	1 (+) 7 (-)
G	7	2	UP	3 (+) 7 (-)
H	Z	2	INDEPENDENT	8 (+) 7 (-)
U	Y	2	INDEPENDENT	8 (+) 7 (-)
		2	INDEPENDENT	10 (+) 9 (-)
SINGLE POLE SWITCHES ONLY				
J	8	1	DOWN	3 (+) 8 (-)
		2	INDEPENDENT	6 (+) 7 (-)
K	W	1	INDEPENDENT	8 (+) 7 (-)
		2	INDEPENDENT	6 (+) 7 (-)
DOUBLE POLE SWITCHES ONLY				
L	9	1	DOWN	3 (+) 6 (-)
M	R	1	UP	3 (+) 6 (-)
N	T	1	DOWN	3 (+) 6 (-)
		2	DOWN	1 (+) 4 (-)
P	V	1	UP	1 (+) 4 (-)
		2	UP	3 (+) 6 (-)

6,7 LAMP (SAME CODING FOR BOTH SELECTIONS)

Selection 6: above terminals 1 & 4; Selection 7: above terminals 3 & 6

No lamp	0			
Neon	1 125VAC	2 250VAC		
Incandescent	4 3V	5 6V	6 12V superbright	7 18V superbright
LED*			8 24V superbright	
	Red	Amber	Green	Red
2VDC	A	L	F	R
6VDC	B	M	G	S
12VDC	C	N	H	T
24VDC	D	P	J	V

* Consult factory for "daylight bright" LED options. Typical current draw for LED is 20ma.

8 FLUSH BRACKET COLOR¹, PANEL SEAL

	Black	White	Gray
No Seal	B	W	G
One Seal	C	Y	H

9 ACTUATOR

- 0 No Actuator
- E Contura IV, left orientation
- T Contura IV, left orientation, laser etched
- F Contura IV, right orientation
- R Contura IV, right orientation, laser etched

1,4



10 LENS

0 - No Actuator Z - No Lens

Clear	White	Amber	Green	Red	Blue
1	6	8	G	M	T
2	7	C	H	N	U
3	8	D	J	P	V
4	9	E	K	R	W
5	A	F	L	S	Y

Lens color for LEDs must be clear, white, or match color of LED. Green or blue lenses are not recommended with Neon lamps.

11 ACTUATOR COLOR^{1,5,6}

No Actuator 0 Black C Gray H Red S White Y Nickel D Pewter E

12 ACTUATOR LENS OR BODY LEGENDS²

11 ON	12 OFF	13 I	14 O
OFF	ON	O	I
15 O O	16 O O	17 O I	18 I O
F N	N F		
F F	F F		

For additional legend options & codes, visit us at www.carlingtech.com.

13 LEGEND ORIENTATION

0 No legend (used with codes 11-18 in selection 12)

- 1 Orientation 1
- 2 Orientation 2
- 3 Orientation 3
- 4 Orientation 4

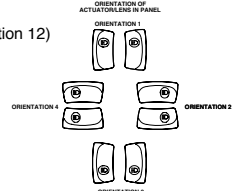
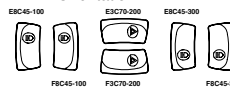

14 ACTUATOR LENS LEGEND

00 No legend this location / no actuator

(used with codes 11-18 in selection 12) Selection 14 required when switch requires two legends. If the two legends consist of one lens and one body legend, lens legend must be specified in selection 12; body legend specified in selection 14. For legend options & codes, visit us at www.carlingtech.com.

Notes:

Consult factory to verify horsepower rating for your particular circuit choice.

- Custom colors are available. Consult factory.
- White imprinting is standard on black actuators; Black imprinting is standard on white, red and gray actuators. Custom colors are available, consult factory.
- Gloss brow is on left side of E actuator and right side of F actuator.
- Additional ratings available. See V-Series Switch Accessories page.
- Laser etched rocker only available with lens code Z & actuator colors black, nickel or pewter.
- Pewter and nickel colors only available with laser etched actuator.

V 1 D A B T O B - G P C 00 - 0 00

1 Series 2 Circuit 3 Rating 4 Termination Illumination 5 Lamp 6 Lamp 7 Lamp 8 Bracket 9 Actuator 10 Lens 11 Color 12 Legend 13 Legend Orientation 14 Actuator Lens Legend

1 SERIES

V

2 CIRCUIT

Terminal Connections as viewed from bottom of switch: () - momentary SP - single pole - uses terminals 1, 2 & 3. DP - double pole uses terminals 1, 2, 3, 4, 5 & 6. Terminals 7, 8, 9 & 10 for lamp circuit only.

Position:	1	2	3
SP DP	2 & 3, 5 & 6	Connected Terminals	1 & 2, 4 & 5
1 A	ON	NONE	OFF
2 B	(ON)	NONE	OFF
3 C	ON	NONE	(OFF)
4 D	ON	NONE	ON
5 F	ON	NONE	(ON)
6 J	ON	OFF	ON
7 K	ON	OFF	(ON)
8 L	(ON)	OFF	(ON)

SPECIAL CIRCUITS

H*	2 & 3	2 & 3, 5 & 4	5 & 4
G*	2 & 3, 5 & 6	2 & 3	OFF
S*	2 & 3, 5 & 6	2 & 3	1 & 2
M*	(2 & 3, 5 & 6)	2 & 3	OFF
E*	(2 & 3, 5 & 6)	2 & 3	2 & 1
R*	5 & 6	5 & 3	5 & 1

*Jumper between terminals 2 & 5 for circuits H, G, M, R & S are specified in selection 4. External jumper between terminals 2 & 4 for circuit E are provided by customer. Circuit E may be used for SP OFF-ON-ON circuit.

3 RATING⁴

- 1 .4VA @ 28VDC Resistive
- B 15A 24V
- C 20A 18V
- D 20A 12V
- E 20A 14V, 10A 14VT (circuit 1, 4, A & D only)
- F 10A 14V, 6A 14VT (circuit G only)
- M .4VA/20A 12V
- N .4VA/15A 24V

4 TERMINATION/BASE STYLE

8 Term	10 Term	Termination	Jumper
1	2	.250 TAB (QC) no barriers	No
A	B	.250 TAB (QC) with barriers	No
J	K	.250 TAB (QC) no barriers	Yes T2 to 5
3	5	Solder Lug no barriers	No
C	D	Solder Lug	No
5	6	Wire Leads no barriers	No
E	F	Wire Leads	No

Note: Codes J & K for circuits H, G & M.

5 ILLUMINATION & SWITCH SEALING

Lamp #1: above terminals 1 & 4 end of switch.; Lamp #2 above terminals 3 & 6 end of switch. Positive (+) and negative (-) symbols apply to LED lamps only

Sealed	Unsealed	Lamps	Illumination Type	Lamp wired to Terminals
S	0	NONE	-	-
A	1	1	INDEPENDENT	8 (+) 7 (-)
B	2	1	DOWN	3 (+) 7 (-)
C	3	2	UP	3 (+) 7 (-)
D	4	1	DOWN	3 (+) 7 (-)
E	5	1	DOWN	1 (+) 7 (-)
		2	UP	1 (+) 7 (-)
		3	UP	3 (+) 7 (-)
F	6	1	INDEPENDENT	8 (+) 7 (-)
		2	UP	3 (+) 6 (-)
G	7	1	INDEPENDENT	8 (+) 7 (-)
		2	UP	3 (+) 7 (-)
H	Z	2	INDEPENDENT	8 (+) 7 (-)
		1	INDEPENDENT	8 (+) 7 (-)
U	Y	1	INDEPENDENT	8 (+) 7 (-)
		2	INDEPENDENT	10 (+) 9 (-)
SINGLE POLE SWITCHES ONLY				
J	8	1	DOWN	3 (+) 8 (-)
K	W	2	INDEPENDENT	6 (+) 7 (-)
		1	INDEPENDENT	8 (+) 7 (-)
P	V	2	INDEPENDENT	6 (+) 7 (-)
		1	UP	1 (+) 4 (-)
DOUBLE POLE SWITCHES ONLY				
L	9	1	DOWN	3 (+) 6 (-)
M	R	1	UP	3 (+) 6 (-)
N	T	1	DOWN	3 (+) 6 (-)
P	V	2	DOWN	1 (+) 4 (-)
		1	UP	1 (+) 4 (-)

6,7 LAMP (SAME CODING FOR BOTH SELECTIONS)

Selection 6: above terminals 1 & 4; Selection 7: above terminals 3 & 6

No lamp	0				
Neon	1 125VAC	2 250VAC			
Incandescent	4 3V	5 6V	6 12V	7 18V	8 24V
LED*			superbright	superbright	
	Red	Amber	Green	Red	
2VDC	A	L	F	R	
6VDC	B	M	G	S	
12VDC	C	N	H	T	
24VDC	D	P	J	V	

* Consult factory for "daylight bright" LED options. Typical current draw for LED is 20ma.

8 FLUSH BRACKET COLOR¹, PANEL SEAL

	Black	White	Gray
No Seal	B	W	G
One Seal	C	Y	H

9 ACTUATOR

- 0 No Actuator
- G Contura V
- P Contura V, laser etched

10 Lens

0 - No Actuator	Z - No Lens				
Clear	White	Amber	Green	Red	Blue
1	6	8	G	M	T bar
2	7	C	H	N	U bar/bar
3	8	D	J	P	V oval
4	9	E	K	R	W oval/bar
5	A	F	L	S	Y oval/oval

Lens color for LEDs must be clear, white, or match color of LED. Green or blue lenses are not recommended with Neon lamps.

11 ACTUATOR COLOR^{1,3,3}

- No Actuator 0
- Black C
- Gray H
- Red S
- White Y
- Nickel D
- Pewter E

12 ACTUATOR LENS OR BODY LEGENDS^{2,6}

11 ON	12 OFF	13 I	14 O
OFF	ON	O	I
15 O O	16 O O	17 O I	18 I O
F N	N F		
F	F		

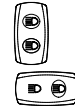

For additional legend options & codes, visit us at www.carlingtech.com.

13 LEGEND ORIENTATION

- 0 No legend (used with codes 11-18 in selection 12)
- 1 Orientation 1
- 2 Orientation 2
- 3 Orientation 3
- 4 Orientation 4

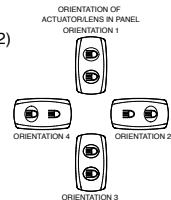
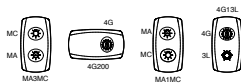

14 ACTUATOR LENS LEGEND

00 No legend this location / no actuator (used with codes 11-18 in selection 12) Selection 14 required when switch requires two legends. If the two legends consist of one lens and one body legend, lens legend must be specified in selection 12; body legend specified in selection 14. For legend options & codes, visit us at www.carlingtech.com.

Notes:

- 1 Consult factory to verify horsepower rating for your particular circuit choice.
- 2 Custom colors are available. Consult factory.
- 3 White imprinting is standard on black actuators; Black imprinting is standard on white, red and gray actuators. Custom colors are available, consult factory.
- 4 Laser Etched rocker only available with lens code Z & actuator colors black, nickel or pewter.
- 5 Additional ratings available. See V-Series Switch Accessories page.
- 6 Nickel and Pewter colors only available with laser etched actuator.
- 7 Consult factory for laser etched lens callout.

V 1 D A S W O B - J Z E 00 - 0

1 Series 2 Circuit 3 Rating 4 Termination 5 Illumination 6 Lock 7 Lamp 8 Bracket 9 Actuator 10 Lens 11 Function 12 Legend 13 Legend Orientation

1 SERIES
V

2 CIRCUIT³
Terminal Connections as viewed from bottom of switch:
8 terminal 10 terminal
3 - 7 8 - -7
1 - 4 1 - -4
2 - 5 2 - -5
3 - 6 3 - -6
10 - -9

() - momentary
SP - single pole - uses terminals 1, 2 & 3.
DP - double pole uses terminals 1, 2, 3, 4, 5 & 6.
Terminals 7, 8, 9 & 10 for lamp circuit only.

Position:

SP DP	1	2	3
1 A	ON	NONE	OFF
4 D	ON	NONE	ON
6 J	ON	OFF	ON
7 K	ON	OFF	(ON)
8 L	(ON)	OFF	(ON)
9 N	OFF	NONE	ON

3 RATING⁴

1 .4VA @ 28VDC Resistive
B 15A 24V
C 20A 18V
D 20A 12V
E 20A 14V, 10A 14VT (circuit 1, 4, A & D only)
F 10A 14V, 6A 14VT (circuit G only)
M .4VA/20A 12V
N .4VA/15A 24V

4 TERMINATION/BASE STYLE

8 term	10 Term	Termination	Jumper
1	2	.250 TAB (QC) no barriers	No
A	B	.250 TAB (QC) with barriers	No
J	K	.250 TAB (QC) no barriers	Yes T2 to 5
3	5	Solder Lug no barriers	No
C	D	Solder Lug	No
5	6	Wire Leads no barriers	No
E	F	Wire Leads	No

Note: Codes J & K for circuits H, G & M.

5 ILLUMINATION & SWITCH SEALING
Lamp #1: above terminals 1 & 4 end of switch.; Lamp #2 above terminals 3 & 6 end of switch. Positive (+) and negative (-) symbols apply to LED lamps only

Sealed	Unsealed	Lamps	Illumination Type	Lamp wired to Terminals
S	0	NONE	-	-
C	3	2	UP	3 (+) 7 (-)
H	Z	2	INDEPENDENT	8 (+) 7 (-)

DOUBLE POLE SWITCHES ONLY

M	R	1	UP	3 (+) 6 (-)
---	---	---	----	-------------

6 LOCK
Lock above terminals 1 & 4 end of switch.
W low profile lock Y⁶ high profile lock

Notes:
Consult factory to verify horsepower rating for your particular circuit choice.
1 Custom colors are available. Consult factory.
2 White imprinting is standard on black actuators; Black imprinting is standard on white, red and gray actuators. Custom colors are available, consult factory.
3 Only available with 3 position circuits. Center OFF and special circuits only available with center position lock function.
4 Additional ratings available. See V-Series Switch Accessories page.
5 Located at T3-6 end of switch.
6 Contura V style only.

7 LAMP
Lamp above terminals 3 & 6 end of switch

No lamp	0	2 250VAC	6 12V superbright	7 18V superbright	8 24V
Neon	1 125VAC	5 6V	Green	Red	
Incandescent	4 3V				
LED*					
	Red	Amber			
2VDC	A	L	F	R	
6VDC	B	M	G	S	
12VDC	C	N	H	T	
24VDC	D	P	J	V	

* Consult factory for "daylight bright" LED options. Typical current draw for LED is 20ma.

8 FLUSH BRACKET COLOR¹, PANEL SEAL

No Seal	Black	White	Gray
One Seal	B	W	G
	C	Y	H

9 HARD SURFACE ACTUATOR

CONTURA IV:
Orientation Black Gray Red White
Left J K L M
Right N P R S

CONTURA V:
Orientation Black Gray Red White
U V W Y

Actuator orientation above terminals: 3,6 1,4

10 LENS⁵

Z - No Lens

Clear	White	Amber	Green	Red	Blue
A	B	C	D	E	F

bar lens
G H J K L M oval lens

Lens color for LEDs must be clear, white, or match color of LED. Green or blue lenses are not recommended with Neon lamps.

11 ACTUATOR LOCK FUNCTION AND COLOR¹

Lock Color	Up	Down	Up & Down	Center ³
Match Actuator	A	H	R	1
Black	B	J	S	2
White	C	K	T	3
Red	D	L	V	4
Safety Orange	E	M	W	5
Gray	F	G	N	6

12 ACTUATOR LENS OR BODY LEGEND²

00 - No Legend

21	22	23	24
OFF	ON	O	I
25 O	26 O	27 O	28 I
F	N		
F			

For additional legend options & codes, visit us at www.carlingtech.com.

13 LEGEND ORIENTATION

0 No legend
1 Orientation 1
2 Orientation 2
3 Orientation 3
4 Orientation 4

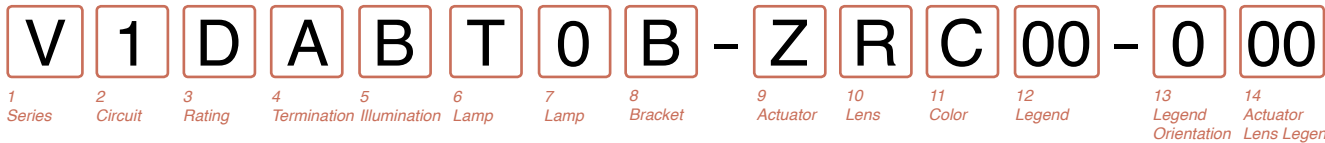

1 SERIES
V

2 CIRCUIT
Terminal Connections as viewed from bottom of switch:
8 terminal 10 terminal
8 - - 7 8 - - 7
1 - - 4 1 - - 4
2 - - 5 2 - - 5
3 - - 6 3 - - 6
10 - - 9

() - momentary
SP - single pole - uses terminals 1, 2 & 3.
DP - double pole uses terminals 1, 2, 3, 4, 5 & 6.
Terminals 7, 8, 9 & 10 for lamp circuit only.

Position:	1	2	3
SP DP	2 & 3, 5 & 6	Connected Terminals	1 & 2, 4 & 5
1	A	ON	NONE
2	B	(ON)	NONE
3	C	ON	NONE
4	D	ON	NONE
5	F	ON	NONE
6	J	ON	OFF
7	K	ON	OFF
8	L	(ON)	OFF

SPECIAL CIRCUITS

	2 & 3	2 & 3, 5 & 4	5 & 4
H*	2 & 3	2 & 3	OFF
G*	2 & 3, 5 & 6	2 & 3	1 & 2
S*	2 & 3, 5 & 6	2 & 3	OFF
M*	(2 & 3, 5 & 6)	2 & 3	2 & 1
R*	(2 & 3, 5 & 6)	2 & 3	5 & 1
E*	5 & 6	5 & 3	5 & 1

*Jumper between terminals 2 & 5 for circuits H,G,M,R & S are specified in selection 4. External jumper between terminals 2 & 4 for circuit E are provided by customer. Circuit E may be used for SP OFF-ON-ON circuit.

3 RATING⁴

1 .4VA @ 28VDC Resistive
B 15A 24V
C 20A 18V
D 20A 12V
E 20A 14V, 10A 14VT (circuit 1, 4, A & D only)
F 10A 14V, 6A 14VT (circuit G only)
M .4VA/20A 12V
N .4VA/15A 24V

4 TERMINATION/BASE STYLE

8 term	10 Term	Termination	Jumper
1	2	.250 TAB (QC) no barriers	No
A	B	.250 TAB (QC) with barriers	No
J	K	.250 TAB (QC) no barriers	Yes T2 to 5
3	5	Solder Lug no barriers	No
C	D	Solder Lug	No
5	6	Wire Leads no barriers	No
E	F	Wire Leads	No

Note: Codes J & K for circuits H, G & M.

5 ILLUMINATION & SWITCH SEALING
Lamp #1: above terminals 1 & 4 end of switch.; Lamp #2 above terminals 3 & 6 end of switch. Positive (+) and negative (-) symbols apply to LED lamps only

Sealed	Unsealed	Lamps	illumination Type	Lamp wired to Terminals
S	0	NONE	-	-
A	1	1	INDEPENDENT	8 (+) 7 (-)
B	2	1	DOWN	3 (+) 7 (-)
C	3	2	UP	3 (+) 7 (-)
D	4	1	DOWN	3 (+) 7 (-)
E	5	2	DOWN	1 (+) 7 (-)
F	6	1	UP	1 (+) 7 (-)
G	7	2	UP	3 (+) 7 (-)
H	Z	2	INDEPENDENT	8 (+) 7 (-)
U	Y	1	INDEPENDENT	8 (+) 7 (-)
		2	INDEPENDENT	10 (+) 9 (-)

SINGLE POLE SWITCHES ONLY

J	8	1	DOWN	3 (+) 8 (-)
K	W	2	INDEPENDENT	6 (+) 7 (-)
		1	INDEPENDENT	8 (+) 7 (-)
		2	INDEPENDENT	6 (+) 7 (-)

DOUBLE POLE SWITCHES ONLY

L	9	1	DOWN	3 (+) 6 (-)
M	R	1	UP	3 (+) 6 (-)
N	T	1	DOWN	3 (+) 6 (-)
P	V	2	DOWN	1 (+) 4 (-)
		1	UP	1 (+) 4 (-)
		2	UP	3 (+) 6 (-)

6.7 LAMP (same coding for both selections)
Selection 6: above terminals 1 & 4; Selection 7: above terminals 3 & 6

No lamp 0
Neon 1 125VAC 2 250VAC
Incandescent 4 3V 5 6V 6 12V superbright 7 18V superbright 8 24V
LED*
Red Amber Green
2VDC A L F
6VDC B M G
12VDC C N H
24VDC D P J

* Consult factory for "daylight bright" LED options. Typical current draw for LED is 20ma.

8 FLUSH BRACKET COLOR¹, PANEL SEAL

	Black	White	Gray
No Seal	B	W	G
One Seal	C	Y	H

9 ACTUATOR

0 No Actuator
Z Contura VII

10 LENS
Lens color for LEDs must be clear, white, or match color of LED. Green or blue lenses are not recommended with Neon lamps.

0 - No Actuator Z - No Lens

White	Amber	Green	Red	Blue	Lens style & location
6	B	G	M	T	
7	C	H	N	U	
8	D	J	P	V	
9	E	K	R	W	
A	F	L	S	Y	
1	2	3	4	5	

11 ACTUATOR COLOR/THUMB PRINT COLOR¹

O N/A - No Actuator C Black/Black
H Grey/Black S Red/Black
Y White/Black

14 ACTUATOR LENS OR BODY LEGENDS²

11 ON 12 OFF 13 I 14 O
OFF ON O I
15 O O 16 O O 17 O I 18 I O
F N N F
F F

For additional legend options & codes, visit us at www.carlingtech.com.

13 LEGEND ORIENTATION

0 No legend (used with codes 11-18 in selection 12)
1 Orientation 1
2 Orientation 2
3 Orientation 3
4 Orientation 4

14 ACTUATOR LENS LEGEND

00 No legend this location / no actuator
(used with codes 11-18 in selection 12) Selection 14 required when switch requires two legends. If the two legends consist of one lens and one body legend, lens legend must be specified in selection 12; body legend specified in selection 14.
For legend options & codes, visit us at www.carlingtech.com.

- Notes:
Consult factory to verify horsepower rating for your particular circuit choice.
- 1 Custom colors are available. Consult factory.
 - 2 White imprinting is standard on black actuators. Black imprinting is standard on white, red and gray actuators. Custom colors are available, consult factory.
 - 3 Additional ratings available. See V-Series Switch Accessories page.
 - 4 Legends available for lighted oval lens version only

Easily integrate Contura products into your system, with Contura Accessories

Contura Connectors

Q.C. SELECTION GUIDE					
COMPANY SERIES	PART NO		WIRE RANGE		ORIENTATION
	PLAIN BRASS	TIN PLATED BRASS	AWG	MM ² (REF)	
PACKARD 58 SERIES	02965580		12	3.0	B
	02965471	12010601	(2)16-14	(2)1.0-2.0	
	02965470		16-14	1.0-2.0	
	02965469	06288318	20-18	.5-.8	
PACKARD METRI-PACK 630 SERIES		12084590	10	5.0	A
		12052224	12	3.0	
		12015870	16-14	1.0-2.0	
		12020035	(2)22-18	(2).5-.8	
		12015832	20-18	.5-.8	
AMP 250 SERIES FASTIN-FASTON	60253-1	60253-2	16-12	1.3-3	B
	42100-1	42100-2	(2) 16	(2) 1.3	
			18-14	.8-2	
	60295-1	60295-2	22-18	.3-.9	

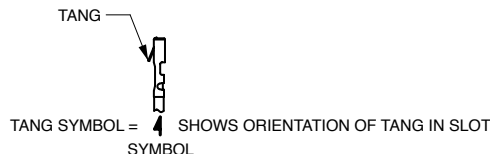

NOTE: Consult Delphi Packard and/or Amp on actual part numbers and availability. AMP is a registered trademark of AMP Inc. Harrisburg, PA. Delphi Packard is a registered trademark of Delphi-Packard Electrical Systems Warren, Ohio

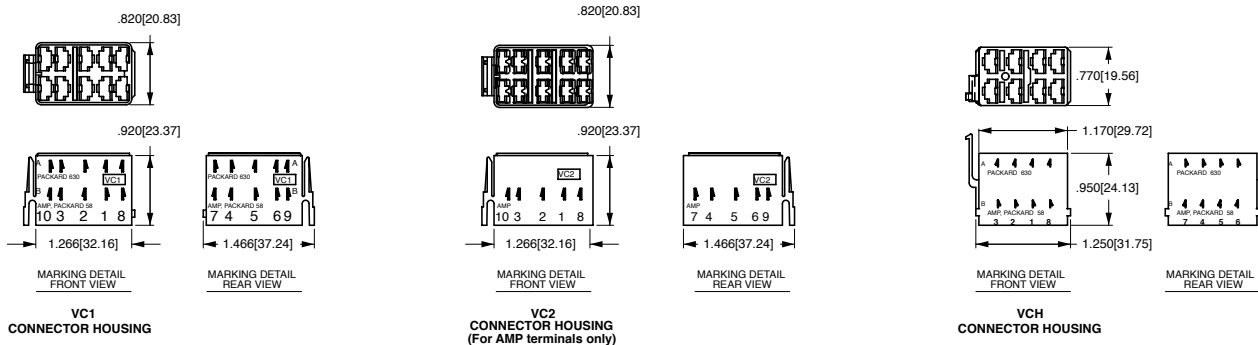

Contura X Boot (P/N VB1-01)

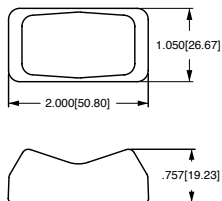

Contura II, III, IV & V Actuator Removal Tool (P/N VRT)

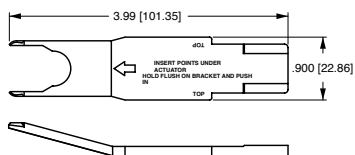

Additional V-Series Ratings

- 1 .4VA @ 28VDC Resistive
- 4 10A 250VAC 1/2 HP, 15A 125 VAC 1/2 HP, No Agency Listings
- 5¹ 10A 250VAC 1/2 HP, 15A 125 VAC 1/2 HP, UL Recognized, CSA Certified
- 6² 15A 125VAC 1/2 HP, 12(2)A 125 VAC μ T85
- 7² 15A 125VAC 1/2 HP, 12(6)A 125 VAC T85
- 8² 10A 250VAC, 15A 125VAC, 1/2 HP 125-250VAC, 12(2)A 250 VAC μ T85
- 9² 10A 250VAC, 15A 125VAC, 1/2 HP 125-250VAC, 12(6)A 250 VAC T85
- B 15A 24V
- C 20A 18V
- D 20A 12V
- E 20A 14V, 10A 14VT (circuits 1, 4, A, & D only)
- F 10A 14V, 6A, 14VT (circuit G only)
- G 20A 6V
- H 20A 3V
- L 15A 125 VAC, 10A 250VAC, 1/2 HP 125-250 VAC; 6A 125 VAC L
- M .4VA/20A 12V (combi-contact)
(combination gold/silver contacts for borderline dry circuit applications)
- N .4VA/15A 24V (combi-contact)
(combination gold/silver contacts for borderline dry circuit applications)

NOTES

- Consult factory to determine availability for individual circuits and their HP rating.
- Not available with Contura 7 or 14 rocker styles.
 - Ratings 6 - 9 are UL, CSA & VDE certified, require terminations A or B for double pole circuits, & are not available with illumination circuits 4, 8, D, J, N, & T or with wire lead or solder lug terminations.
- Circuits 1, 4, A, D, H, M & E are not available with rating 6 & 8. Rating 7 & 9 only available with circuits 1, 4, A & D. Circuits 2, 3, 5, 7, 8, K, L are 1/2 HP 250VAC only with rating 8. Ratings 6 & 7 must specify lamp code 1 (125VAC neon). Ratings 8 & 9 must specify lamp code 2 (250VAC neon). Rating L available with circuits 1, 4, A & D only.

Contura Mounting Panels Dimensional Specifications: in. [mm]

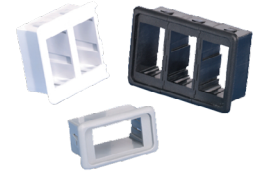

MOUNTING PANEL
For additional units, add 1.03[26.2] per unit.
For more than 2 V-Series Switches, add
middle section. Available in Panel Thicknesses
listed below. Consult factory.

MOUNTING PANEL THICKNESS	
.062[1.57]	.187[4.75]
.093[2.36]	.250[6.35]
.125[3.17]	.375[9.52]

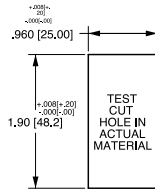

VMS
MOUNTING PANEL
HOLE

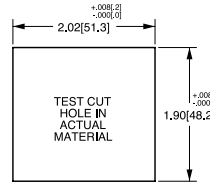

MOUNTING PANEL
OPENING
(2) UNITS

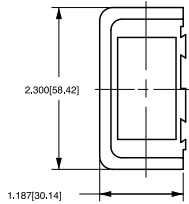

VME
MOUNTING
PANEL
END

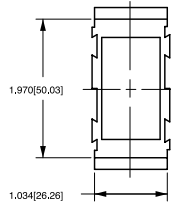

VMM
MOUNTING PANEL
MIDDLE

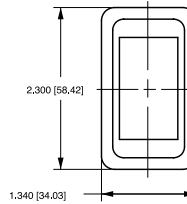

VMS
MOUNTING
PANEL

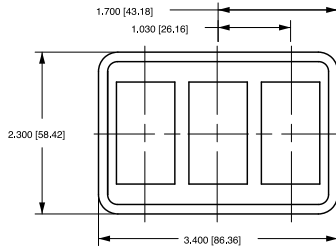

VM3
MOUNTING PANEL

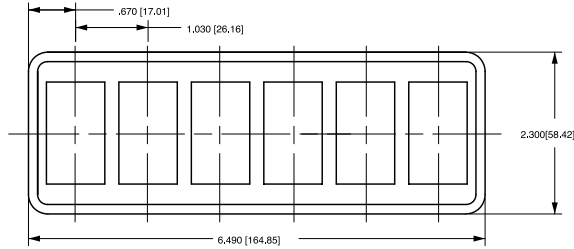

VM6
MOUNTING PANEL

Contura Hole Plug Dimensional Specifications: in. [mm]

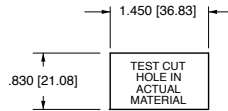

VHP
CONTURA II,III HOLE PLUG

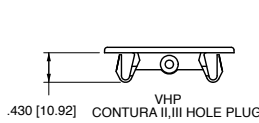

VHP
CONTURA II,III HOLE PLUG

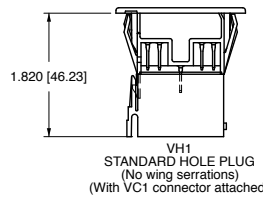

VH1
STANDARD HOLE PLUG
(No wing serrations)
(With VC1 connector attached)

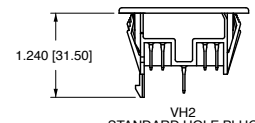

VH2
STANDARD HOLE PLUG
(With wing serrations)

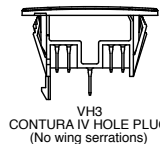
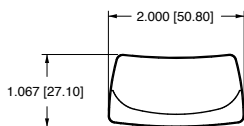

VH3
CONTURA IV HOLE PLUG
(No wing serrations)

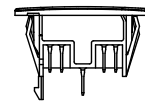

VH4
CONTURA IV HOLE PLUG
(With wing serrations)



DETAIL VIEW
VH1, VH3 & VH5
HOLE PLUGS
(No wing serrations
for ease of removal)

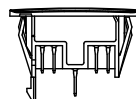
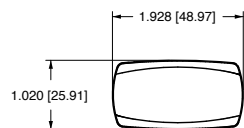

VH5
CONTURA V HOLE PLUG
(No wing serrations)

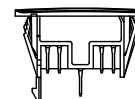

VH6
CONTURA V HOLE PLUG
(With wing serrations)



DETAIL VIEW
VH2, VH4 & VH6
HOLE PLUGS
(With wing serrations)

Authorized North America Sales Representatives

Carling extensive sales representative network group is strategically located and ready to answer any questions. Find your local representative by clicking on a group name on the map below or by visiting www.carlingtech.com/findarep.



About Carling

Founded in 1920, Carling Technologies is a leading manufacturer of electrical and electronic switches and assemblies, circuit breakers, electronic controls, power distribution units, and multiplexed power distribution systems. With four ISO registered manufacturing facilities and technical sales offices worldwide, Carling Technologies Sales, Service and Engineering teams do much more than manufacture electrical components, they engineer powerful solutions! To learn more about Carling please visit www.carlingtech.com/company-profile.

Worldwide Headquarters

Carling Technologies, Inc.
60 Johnson Avenue • Plainville, CT 06062
Phone: (860) 793-9281 • Fax: (860) 793-9231
Email: sales@carlingtech.com • www.carlingtech.com

East Region Sales Office, CT • ersm@carlingtech.com
Midwest Region Sales Office, IL • mrsm@carlingtech.com
West Region Sales Office, CA • wrsm@carlingtech.com

Asia-Pacific Headquarters

Carling Technologies, Asia-Pacific Ltd.,
Kowloon, Hong Kong
Int + 852-2737-2277 • Fax: Int + 852-2736-9332
Email: sales@carlingtech.com.hk

Shenzhen, China • shenzhen@carlingtech.com
Shanghai, China • shanghai@carlingtech.com
Pune, India • india@carlingtech.com
Kaohsiung, Taiwan • taiwan@carlingtech.com
Yokohama, Japan • japan@carlingtech.com

Europe / Middle East / Africa Headquarters

Carling Technologies LTD
4 Airport Business Park, Exeter Airport,
Clyst Honiton, Exeter, Devon, EX5 2UL, UK
Int + 44 1392-364422 • Fax: Int + 44 1392-364477
Email: ltd.sales@carlingtech.com

GmbH, Germany • gmbh@carlingtech.com
SAS, France • sas@carlingtech.com

REV_SW_V_08_2014



Carling Technologies™

Innovative Designs. Powerful Solutions.