



Interconnect Product
CATALOG Q700





Quest Network Products Warranty

QUEST Technology International Inc., carries a **LIFETIME** warranty on all Category-Rated link components and a three year warranty on all Active Networking Products, from the date of purchase. QUEST Technology warrants all products to be free from manufacturing and or material defects. This warranty will not extend to any product, which has been subject to misuse, negligence, accident or improper installation or used in the violation of instructions. QUEST's liability shall be limited to the repair and or replacement of our product. QUEST Technology assumes no liability with respect to the use of its products including merchantability or the fitness for a particular use. QUEST technology assumes no liability for any consequential damages directly or indirectly caused from the use of our products or from any other cause if proven defective.



Warranty

QUEST Technology International Inc. warrants all other products to be free from any manufacturing and/or material defects for a period of one year from the date of purchase. This warranty will not extend to any product that has been subject to misuse, negligence, accident, improper installation, or used in the violation of instructions. QUEST's liability shall be limited to the repair and/or replacement of our products. QUEST Technology assumes no liability with respect to the use of its products including merchantability or fitness for a particular use. QUEST Technology assumes no liability for any consequential damages caused directly or indirectly by the use of our products or from any other cause if proven defective. This warranty extends to all the products listed in QUEST's current price list.



Lifetime Warranty Termination Tools

QUEST Technology International Inc. warrants its termination tools to be free from any manufacturing and or material defects. This warranty extends for the **LIFETIME** of the tool from the date of purchase. This warranty will not extend to any tool that has been subject to misuse, negligence, abuse, or altered in any manner; or used in the violation of instructions. This warranty excludes any wearable components; such as crimp die sets or strip blade sets. QUEST's liability shall be limited to the repair and or replacement of the tool. QUEST Technology assumes no liability with respect to the use of its tools including merchantability and/or fitness for a particular use. QUEST Technology assumes no liability for any consequential damage directly or indirectly caused from the use of its tools or from any other cause if proven defective.

Our Quest

QUEST Technology International is a new interconnect supplier offering leading edge capabilities, business and supply chain solutions for our distributors worldwide. QUEST provides quality, solutions oriented and competitively priced interconnect active and passive components, technical support and cross-referencing to better serve the distribution marketplace and its customers. QUEST is a supplier who provides a stable source of quality products for lan networking, telecommunications, broadcast, value-added, security, home entertainment, MRO and OEM commercial and residential markets.

Our Products

QUEST Technology International offers a diverse product selection with over 750 interconnect products including complete solution networking active and passive for data and voice, RF connectors and adapters, installation tools and testers, computer connectivity, cable assemblies CATV/MATV/Satellite and Home-Theater. Our products are available through authorized QUEST Technology Distributors Worldwide.

Our Confidence

QUEST Technology International warrants all category-rated link components for the lifetime of its use. This warranty covers products subject to proper installation and use, for material/workmanship and performance defects and is limited to the repair or replacement of these products. Active Network Channel components are warranted for a period of 3 years from date of purchase for material/workmanship and performance limited to the repair or replacement of these products. All other products are warranted under distributor terms / policies / conditions. Please Consult your local distributor.



Index



Lan Connectivity

- Patch Panels - CAT5e Loaded / Unloaded..... 2-3
- CAT3 / CAT5e Keystone Jacks..... 4-5
- Faceplates..... 6-9
- Surface Mount Boxes..... 10-11
- CAT5e Patch Cables..... 12
- Modular Plugs / Modular Adapters..... 13
- Network Testers..... 14-15
- Fiber Optic Products..... 16-17
- Active Network Products..... 18-21



Wire Management

- Raceway System..... 22
- Cable Ties and Fasteners..... 23
- Relay Racks / Equipment Cabinets..... 24
- Cable Managers / Wall Brackets..... 25
- Shelves / Trays..... 26-27



Telephone

- Wall Plates..... 28
- Surface Boxes / Couplers / Adapters..... 29
- Cable Assemblies / Bulk Cable..... 30



Computer

- D-Subminiature Gender Adapters / Data Switches..... 31
- Computer Cable Assemblies..... 32-33
- D-Subminiature Connectors..... 34
- D-Subminiature Hoods / Hardware..... 35





RF Coaxial Connectors

- BNC 50 and 75 OHM Connectors..... 36-38
- BNC Specialty Connectors / BNC Faceplates..... 39
- N Series..... 40
- UHF Series..... 41
- Mini-UHF, TNC, Twin-Axial..... 42
- F Series..... 43-45
- Interseries Adapters..... 46-49



Installation Tools

- Standard RF Crimp Tools..... 50
- Ratchet RF Crimp Tools..... 51
- Strippers and Cable Cutters..... 52-54
- Punch-Down Tools..... 55
- Modular Crimp Tools..... 56-57
- Lineman's Butt Set /Tone Generator and Probe..... 57
- Fiber Optic Termination Kit..... 58



CATV / MATV / Satellite

- Splitters / Signal Combiners..... 60-62
- Switches / Signal Amplifiers / Impedance Transformers..... 63-65



Audio / Video / Home Theater

- Video / DBS Wall Plates..... 69
- Video / Audio Cable Assemblies..... 66-68
- Home Theater Wall Plates..... 70-71



Appendix

- Glossary of Terms..... 72-73
- Product Index..... 74-75
- Connector Termination Instructions..... 76
- Part Number Index..... 77-79



CATEGORY 5e PATCH PANELS

**Lifetime
Warranty**

**Category
5e**

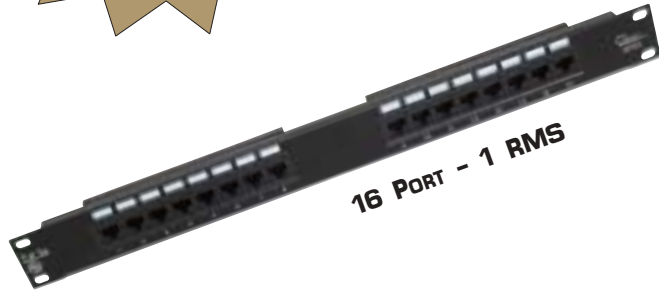

16 PORT - 1 RMS



24 PORT - 1 RMS

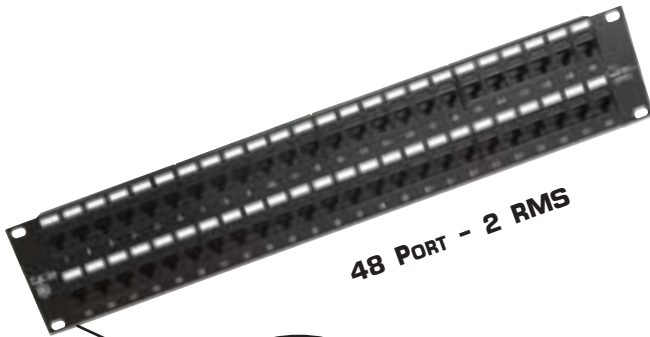

48 PORT - 2 RMS

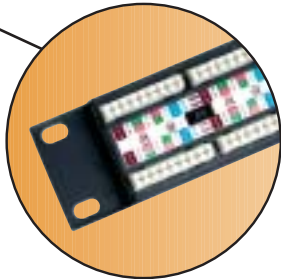

**Universal 568A & 568B
Wiring with Color-coded Labels**



QUEST's Category 5e series patch panels provide several options for cross-connect solutions. They are Category 5e compliant, which meet or exceed TIA/EIA 568-A specifications and are offered in 16, 24 and 48 port configurations for 19" horizontal rack-mount installation. In addition, a 12-port "mini" vertical wall-mount panel is offered for small office cross connect applications. The panels are universally configured for both 568A and 568B wiring standards with easy to read, color-coded labels indicating the proper wiring scheme, and are designed with double folded frames offering outstanding resistance to twisting. The PC boards are protected with a terminal housing cover to protect them from damage when using a punch down tool. Termination is with 110 blocks, which accept 22-24 AWG cable.

FEATURES:

- 50u" GOLD PLATED CONTACTS
- DOUBLE FOLDED FRAMES
- 568A AND 568B UNIVERSAL WIRING
- PROTECTIVE PC BOARD COVERS
- UL LISTED

ITEM #	DESCRIPTION
NPP-1012	12 PORT CAT5e MINI PATCH PANEL, WITH BRACKET
NPP-1016	16 PORT CAT5e 19" PATCH PANEL
NPP-1024	24 PORT CAT5e 19" PATCH PANEL
NPP-1048	48 PORT CAT5e 19" PATCH PANEL



**12 PORT - MINI VERTICAL
WITH 89D BRACKET**

BLANK PATCH PANELS & ACCESSORIES

QUEST's line of unloaded patch panels offer a versatile way to adapt various inserts allowing custom configurations for multimedia cross-connect applications. These panels are numbered and accept our iconable line of modular bezels for voice or CAT5e keystone jacks. In addition, other bezels designed to fit these panels include applications for BNC, F-Video, SC and ST Fiber connectivity. Also featured are blank inserts to plug unused ports. To identify the ports, the insert bezels can be identified with our line of blank or marked color-coded icons.

ITEM #	DESCRIPTION
--------	-------------

NBP-2016	16 PORT BLANK PATCH PANEL
NBP-2024	24 PORT BLANK PATCH PANEL
NBP-2048	48 PORT BLANK PATCH PANEL
NIN-1000	ICONABLE KEYSTONE BEZEL - BLACK
NIN-1002	ICONABLE KEYSTONE BEZEL - BLUE
NIN-1003	ICONABLE KEYSTONE BEZEL - RED
NIN-1005	ICONABLE KEYSTONE BEZEL - YELLOW
NIN-1006	ICONABLE KEYSTONE BEZEL - GREEN
NIN-1008	ICONABLE KEYSTONE BEZEL - WHITE
NIN-1500	COAX MODULAR BEZEL - WHITE
NIN-1501	BLANK MODULAR BEZEL - WHITE
NIN-1502	F-81 MODULAR BEZEL - WHITE
NIN-1503	SC FIBER MODULAR BEZEL - WHITE
NIN-1504	ST FIBER MODULAR BEZEL - WHITE
NIN-2001	ICON TREE - MARKED - BLACK
NIN-2002	ICON TREE - MARKED - BLUE
NIN-2003	ICON TREE - MARKED - RED
NIN-2004	ICON TREE - MARKED - ORANGE
NIN-2005	ICON TREE - MARKED - YELLOW
NIN-2006	ICON TREE - MARKED - GREEN
NIN-2007	ICON TREE - MARKED - IVORY
NIN-2008	ICON TREE - MARKED - WHITE
NIN-3002	ICONS - UNMARKED - BLUE
NIN-3003	ICONS - UNMARKED - RED
NIN-3005	ICONS - UNMARKED - YELLOW
NIN-3006	ICONS - UNMARKED - GREEN
NIN-3008	ICONS - INMARKED - WHITE



16 PORT - 1 RMS



24 PORT - 2 RMS

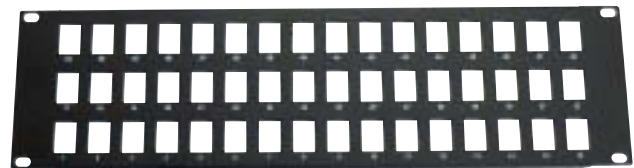

48 PORT - 3 RMS



ICONABLE KEYSTONE BEZELS



MODULAR BEZELS



UNMARKED COLOR ICONS

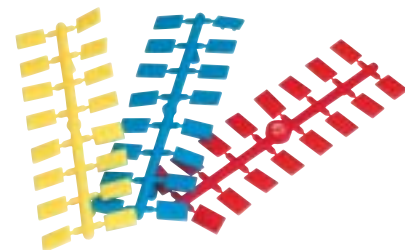

MARKED ICON TREES

CATEGORY 5E COMMUNICATIONS JACKS



Universal 568A & 568B Wiring

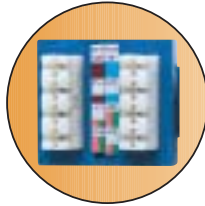

90° CONFIGURATION



Universal 568A & 568B Wiring



180° CONFIGURATION

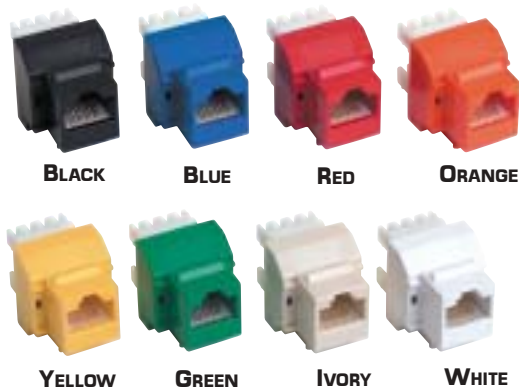

QUEST's line of Category 5e RJ-45 8 conductor keystone jacks meet or exceed TIA/EIA 568-A requirements and can be used with our entire line of multi-outlet faceplates or can be installed on QUEST's line of blank patch panels for added versatility. They are available in 90° or 180° designs, 8 different colors and are universally wired for either 568A or 568B wiring configurations.

FEATURES:

- 50u" GOLD PLATED CONTACTS
- 568A OR 568B UNIVERSAL WIRING
- UL LISTED
- AVAILABLE IN 8 COLORS
- 90° OR 180° DESIGNS

ITEM #	DESCRIPTION
NKJ-5101	90° CAT5e KEYSTONE JACK 568A/B - BLACK
NKJ-5102	90° CAT5e KEYSTONE JACK 568A/B - BLUE
NKJ-5103	90° CAT5e KEYSTONE JACK 568A/B - RED
NKJ-5104	90° CAT5e KEYSTONE JACK 568A/B - ORANGE
NKJ-5105	90° CAT5e KEYSTONE JACK 568A/B - YELLOW
NKJ-5106	90° CAT5e KEYSTONE JACK 568A/B - GREEN
NKJ-5107	90° CAT5e KEYSTONE JACK 568A/B - IVORY
NKJ-5108	90° CAT5e KEYSTONE JACK 568A/B - WHITE
NKJ-5201	180° CAT5e KEYSTONE JACK 568A/B - BLACK
NKJ-5202	180° CAT5e KEYSTONE JACK 568A/B - BLUE
NKJ-5203	180° CAT5e KEYSTONE JACK 568A/B - RED
NKJ-5204	180° CAT5e KEYSTONE JACK 568A/B - ORANGE
NKJ-5205	180° CAT5e KEYSTONE JACK 568A/B - YELLOW
NKJ-5206	180° CAT5e KEYSTONE JACK 568A/B - GREEN
NKJ-5207	180° CAT5e KEYSTONE JACK 568A/B - IVORY
NKJ-5208	180° CAT5e KEYSTONE JACK 568A/B - WHITE
NKJ-5001	CAT5e RJ45 IN-LINE COUPLER



CAT 5e IN-LINE coupler RJ-45 8 CONTACT. Allows cabling to be lengthened without compromising signal integrity. PC board construction.

QUEST offers 6 position, 6 contact and 8 position, 8 contact Category 3/4 modular keystone jacks for data and voice applications. These jacks are compliant with Category 3/4 requirements for connecting hardware. They can be wired without tools using the termination cap and insulation displacement contacts for ease of installation of all 4 pairs simultaneously. Wire range is 22-26 AWG solid or stranded wire.



6P/6C Ivory



6P/6C Black



8P/8C Black

ITEM # **DESCRIPTION**

NKJ-4601	6P/6C CATEGORY 3 JACK- BLACK
NKJ-4608	6P/6C CATEGORY 3 JACK - IVORY
NKJ-4801	8P/8C CATEGORY 3 JACK- BLACK

Why are there two standard color codes for LAN wiring?

Although no clear answer exists the fact is there just are. The two approved color code schemes for TIA/EIA 568A are 568A and 568B not to be confused with the standard itself. The only difference between the two codes is that the green and orange pairs are reverse. There are some very good reasons to know the two codes, which include the following:

1. The customer or jobber has a stated preference.
2. Some material for the job has already been purchased and it is of only one configuration of color code.
3. There is existing wiring already established with a particular color code.

If none of these conditions apply the only basic industry guide lines are that 568B color code is used primarily for commercial installations and 568A color code is used primarily for residential installations. The main concern is that you keep the same color code throughout any particular link in the channel.

356A, T568B & WECO TWISTED PAIR		
PAIR ID	T568B PIN#	TWISTED PAIR COLOR
T2	1	
R2	2	
T3	3	
R1	4	
T1	5	
R3	6	
T4	7*	
R4	8*	

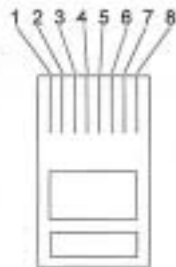

T568A TWISTED PAIR		
PAIR ID	T568A PIN#	TWISTED PAIR COLOR
T3	1	
R3	2	
T2	3	
R1	4	
T1	5	
R2	6	
T4	7	
R4	8	

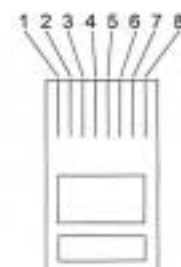

STANDARD MULTIMEDIA FACEPLATES



1 PORT IVORY



1 PORT WHITE



2 PORT IVORY



2 PORT WHITE



3 PORT IVORY



3 PORT WHITE

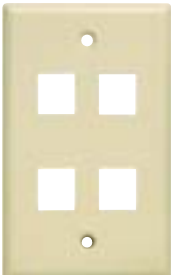

4 PORT IVORY



4 PORT WHITE

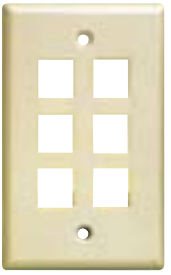

6 PORT IVORY



6 PORT WHITE

QUEST's standard series multimedia faceplates offer an economical solution for workstation connectivity. They accommodate category 3 and higher keystone jacks and a complete series of snap-in modules for RF and video applications. The standard series faceplates are designed to fit standard single gang electrical boxes, are offered in white and ivory and come complete with mounting screws.

The snap-in modules offer versatility in configuring communication interfaces to support audio, video and security applications. The snap-in modules are offered in white and ivory and are designed to snap in place from the rear.

ITEM #	DESCRIPTION
NFP-1017	1 PORT MULTIMEDIA FACEPLATE - IVORY
NFP-1018	1 PORT MULTIMEDIA FACEPLATE - WHITE
NFP-1027	2 PORT MULTIMEDIA FACEPLATE - IVORY
NFP-1028	2 PORT MULTIMEDIA FACEPLATE - WHITE
NFP-1037	3 PORT MULTIMEDIA FACEPLATE - IVORY
NFP-1038	3 PORT MULTIMEDIA FACEPLATE - WHITE
NFP-1047	4 PORT MULTIMEDIA FACEPLATE - IVORY
NFP-1048	4 PORT MULTIMEDIA FACEPLATE - WHITE
NFP-1067	6 PORT MULTIMEDIA FACEPLATE - IVORY
NFP-1068	6 PORT MULTIMEDIA FACEPLATE - WHITE
NIN-1107	BLANK COVER INSERT - IVORY
NIN-1108	BLANK COVER INSERT - WHITE
NIN-1207	F INSERT - LOADED - IVORY
NIN-1208	F INSERT - LOADED - WHITE
NIN-1307	BNC INSERT - LOADED - IVORY
NIN-1308	BNC INSERT - LOADED - WHITE



BLANK INSERT IVORY

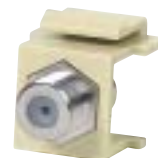

F-81 INSERT IVORY



BNC INSERT IVORY



BLANK INSERT WHITE



F-81 INSERT WHITE



BNC INSERT WHITE

ICONABLE MULTIMEDIA FACEPLATES

QUEST's Iconable Multimedia Series Faceplates are designed where station identification is required. This series accepts QUEST's line of Category 3 and higher keystone jacks. They also feature slots to facilitate insertion of icons for color-coding application or department identification. Additionally, each faceplate features clear station labels for station ID. They are offered in 1, 2, 4 and 6 port configurations and in ivory and white colors. They come complete with mounting screws, station labels and clear plastic overlays. The snap-in series of modules are also compatible with the Iconable series as shown for the standard series faceplates on page 6.

ITEM #	DESCRIPTION
--------	-------------

NFP-2017	1 PORT ICONABLE FACEPLATE - IVORY
NFP-2018	1 PORT ICONABLE FACEPLATE - WHITE
NFP-2027	2 PORT ICONABLE FACEPLATE - IVORY
NFP-2028	2 PORT ICONABLE FACEPLATE - WHITE
NFP-2047	4 PORT ICONABLE FACEPLATE - IVORY
NFP-2048	4 PORT ICONABLE FACEPLATE - WHITE
NFP-2067	6 PORT ICONABLE FACEPLATE - IVORY
NFP-2068	6 PORT ICONABLE FACEPLATE - WHITE



Clear Station Markers

Icon Slots

Multimedia Outlets



1 PORT IVORY



1 PORT WHITE



2 PORT IVORY



2 PORT WHITE

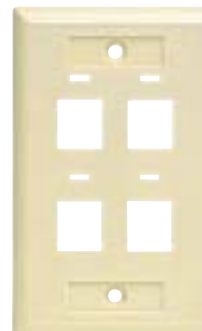

4 PORT IVORY



4 PORT WHITE



6 PORT IVORY



6 PORT WHITE

ANGLED MULTIMEDIA FACEPLATES

Clear Station Markers

Angled Outlets for improved wall clearance

Compatible with QUEST bezels

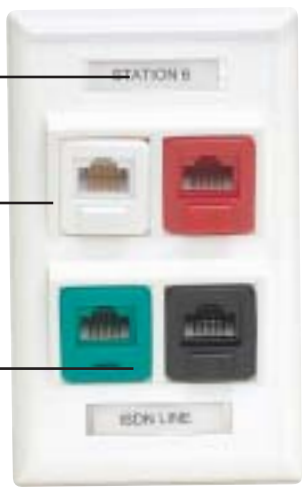

QUEST's angled multimedia faceplate series are designed with 45° molded outlets, which optimize bend radius for applications where clearance space is critical. These faceplates work in conjunction with a series of Iconable bezel inserts, which accommodate Category 3, 5, 5e and higher keystone jacks in various colors for workstation identification. In addition, a series of multimedia bezels are offered designed to accept video, coax and fiber connectors. A single gang surface mount box is offered for applications where surface mounting is required. The junction box also accommodates other single gang faceplates.



1 PORT WHITE



2 PORT WHITE



4 PORT WHITE



OUTLET BOX

ITEM #	DESCRIPTION
NFP-3018	1 PORT 45° ANGLED FACEPLATE - WHITE
NFP-3028	2 PORT 45° ANGLED FACEPLATE - WHITE
NFP-3048	4 PORT 45° ANGLED FACEPLATE - WHITE
NFP-3000	SINGLE GANG OUTLET BOX - WHITE
NIN-1008	ICONABLE KEYSTONE JACK BEZEL - WHITE
NIN-1000	ICONABLE KEYSTONE JACK BEZEL - BLACK
NIN-1002	ICONABLE KEYSTONE JACK BEZEL - BLUE
NIN-1003	ICONABLE KEYSTONE JACK BEZEL - RED
NIN-1006	ICONABLE KEYSTONE JACK BEZEL - GREEN
NIN-1005	ICONABLE KEYSTONE JACK BEZEL - YELLOW
NIN-1500	COAX MODULAR BEZEL - WHITE
NIN-1501	BLANK MODULAR BEZEL - WHITE
NIN-1502	F FEED-THRU MODULAR BEZEL - WHITE
NIN-1503	SC FIBER MODULAR BEZEL - WHITE
NIN-1504	ST FIBER MODULAR BEZEL - WHITE

ICONABLE KEYSTONE BEZELS

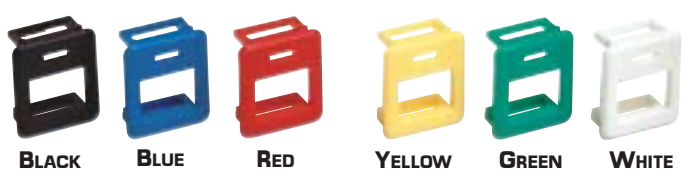

MODULAR BEZELS



*All Quest communications jacks will fit above faceplates
Please see pages 3 for icon inserts*

LAN CONNECTIVITY

DÉCOR FACEPLATE SYSTEMS

The QUEST Décor series of contemporary styled faceplates match the appearance of many electrical wiring faceplates used in residential and commercial installations. This modular series allows the installation of plastic single gang or stainless steel single or dual gang faceplates with a single, iconable, 3-outlet module base insert, which accepts QUEST's line of Category rated keystone jacks. In addition, a variety of modular inserts are offered for video and RF connectors as well as a blank insert for disabling any unused port. The faceplate module base and faceplates mount into any standard electrical box.

FEATURES:

- MULTIMEDIA VERSATILITY
- ICONABLE OUTLET MODULE
- PLASTIC OR STAINLESS STEEL
- CONTEMPORARY DÉCOR STYLING

ITEM #	DESCRIPTION
NFP-4011	DECOR PLASTIC SINGLE GANG FACEPLATE - WHITE
NFP-4012	DECOR STAINLESS STEEL SINGLE GANG FACEPLATE
NFP-4013	DECOR SATINLESS STEEL DUAL GANG FACEPLATE
NFP-4014	DECOR 3-OUTLET MODULAR BASE - WHITE
NIN-1108	BLANK COVER INSERT - WHITE
NIN-1208	F FEED-THRU INSERT LOADED - WHITE
NIN-1308	BNC RF INSERT LOADED - WHITE

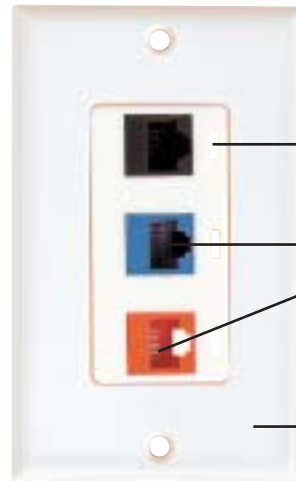

Slots for Icons

Data/Voice Outlets

Contemporary Décor Style Face Plates



SINGLE GANG PLASTIC



SINGLE GANG STAINLESS STEEL



3 OUTLET MODULE



DUAL GANG STAINLESS STEEL

*All Quest communications jacks will fit above faceplates
Please see pages 3 for icon inserts*



BLANK INSERT



F-81 INSERT



BNC INSERT

Dual & Triple Gang Plastic Faceplates are available - See page 71

SURFACE MOUNT BOXES WITH CAT5e JACKS

Lifetime Warranty

Category 5e

QUEST offers a variety of surface mount boxes with integral CAT5e jacks for installations where cost-effective surface terminations are required. The boxes are offered in single and dual outlet versions complete with CAT5e jacks. The jacks feature PC board construction, meet TIA/EIA 568-A requirements and are configured for 568A and 568B wiring standards. Terminations include 110 and Krone and are packaged complete with mounting screws and double-sided adhesive tape.

FEATURES:

- CAT5e RATED
- INTEGRAL BOX AND JACK
- COST EFFECTIVE
- UNIVERSAL 568A OR 568B WIRING
- LIFETIME WARRANTY
- HARDWARE INCLUDED



SINGLE 110 CAT5e



DUAL 110 CAT5e

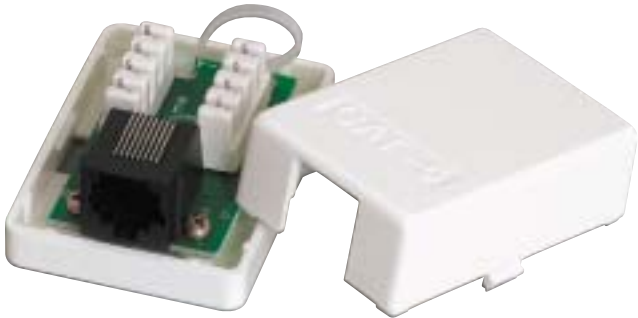

SINGLE KRONE CAT5e



DUAL KRONE CAT5e

ITEM #	DESCRIPTION
NSB-5120	1 PORT SURFACE BOX WITH CAT5e JACK - PC BOARD-110 TERMINATION - WHITE
NSB-5130	2 PORT SURFACE BOX WITH CAT5e JACKS - PC BOARD-110 TERMINATIONS-WHITE
NSB-5100	1 PORT SURFACE BOX WITH CAT5e JACK -PC BOARD—KRONE TERMINATION - WHITE
NSB-5110	2 PORT SURFACE BOX WITH CAT5e JACKS- PC BOARD-KRONE TERMINATION - WHITE

LAN CONNECTIVITY

UNLOADED SURFACE MOUNT BOXES

The QUEST series of surface mount boxes offers a wide choice of surface termination choices. They are available in single through 6 outlet port configurations and most are offered with a choice of ivory or white case colors. The single and dual are offered with shutter windows, which protect against dust and contamination while not in use. They are compact and are easy to install on flat surfaces utilizing the enclosed mounting screws or double-side adhesive tape. These boxes are designed to accommodate QUEST's line of category rated keystone jacks as well as other competitive types.

FEATURES:

- MULTIPLE OUTLET CHOICES
- EASY TO INSTALL
- COST EFFECTIVE
- COMPLETE WITH MOUNTING HARDWARE

ITEM #	DESCRIPTION
NSB-6140	1 PORT SURFACE KEYSTONE JACK BOX WITH SHUTTER - WHITE
NSB-6240	2 PORT SURFACE KEYSTONE JACK BOX WITH SHUTTER - WHITE
NSB-5150	2 PORT SURFACE KEYSTONE JACK BOX - WHITE - FOR 90° JACKS ONLY
NSB-5151	2 PORT SURFACE KEYSTONE JACK BOX - IVORY - FOR 90° JACKS ONLY
NSB-5160	4 PORT SURFACE KEYSTONE JACK BOX - WHITE - FOR 90° JACKS ONLY
NSB-5161	4 PORT SURFACE KEYSTONE JACK BOX - IVORY - FOR 90° JACKS ONLY
NSB-5170	6 PORT SURFACE KEYSTONE JACK BOX - WHITE - FOR 90° JACKS ONLY
NSB-5171	6 PORT SURFACE KEYSTONE JACK BOX - IVORY - FOR 90° JACKS ONLY



SINGLE UNLOADED SHUTTER



DUAL UNLOADED SHUTTER



DUAL IVORY



DUAL WHITE



6 PORT BOX



4 PORT BOX

CATEGORY 5e PATCH CORDS

**Lifetime
Warranty**

QUEST's Enhanced Category 5 UTP patch cords feature a molded strain-relief boot design in both snagless and non-snagless types. They exceed specified performance as stated in TIA/EIA 568-A for connecting hardware, manufactured with 50u" gold plated modular connectors and are offered in 7 colors for easy port or link identification. Lifetime warranted.

NON-SNAGLESS

COLOR	3 FT	7 FT	10 FT	15 FT	25 FT
BLACK	NPC-0103	NPC-0107	NOC-0110	NPO-0115	NPC-0125
BLUE	NPC-0203	NPC-0207	NPC-0210	NPC-0215	NPC-0225
GRAY	NPC-0903	NPC-0907	NPC-0910	NPC-0915	NPC-0925
GREEN	NPC-0603	NPC-0607	NPC-0610	NPC-0615	NPC-0625
RED	NPC-0303	NPC-0307	NPC-0310	NPC-0315	NPC-0325
WHITE	NPC-0803	NPC-0807	NPC-0810	NPC-0815	NPC-0825
YELLOW	NPC-0503	NPC-0507	NPC-0510	NPC-0515	NPC-0525

SNAGLESS

COLOR	3 FT	7 FT	10 FT	15 FT	25 FT
BLACK	NPC-1103	NPC-1107	NOC-1110	NPC-1115	NPC-1125
BLUE	NPC-1203	NPC-1207	NPC-1210	NPC-1215	NPC-1225
GRAY	NPC-1903	NPC-1907	NPC-1910	NPC-1915	NPC-1925
GREEN	NPC-1603	NPC-1607	NPC-1610	NPC-1615	NPC-1625
RED	NPC-1303	NPC-1307	NPC-1310	NPC-1315	NPC-1325
WHITE	NPC-1803	NPC-1807	NPC-1810	NPC-1815	NPC-1825
YELLOW	NPC-1503	NPC-1507	NPC-1510	NPC-1515	NPC-1525



LAN CONNECTIVITY

MODULAR PLUGS/MODULAR BOOTS MODULAR ADAPTERS

QUEST offers a wide range of modular connectivity products and accessories. These include a full selection of UL listed modular plugs, strain relief RJ-45 boots in 8 different colors and modular adapters which allow the transition from multi-conductor to twisted pair. The modular adapters are offered in gray.

MODULAR PLUGS

ITEM #	DESCRIPTION
NMP-9000	4P4C FOR HANDSET
NMP-4111	6P4C FOR FLAT STRANDED - UL
NMP-4221	6P4C FOR ROUND SOLID - UL
NMP-6111	6P6C FOR FLAT STRANDED - UL
NMP-6221	6P6C FOR ROUND SOLID - UL
NMP-8111	8P8C FOR FLAT STRANDED - UL
NMP-8215	8P8C ROUND STRANDED - 50u" GOLD PLATED UL - FOR CAT5e
NMP-8225	8P8C ROUND SOLID - 50u" GOLD PLATED - UL FOR CAT5e

MODULAR BOOTS

ITEM #	DESCRIPTION
NMB-1001	RJ-45 MODULAR BOOT - BLACK
NMB-1002	RJ-45 MODULAR BOOT - BLUE
NMB-1003	RJ-45 MODULAR BOOT - RED
NMB-1005	RJ-45 MODULAR BOOT - YELLOW
NMB-1006	RJ-45 MODULAR BOOT - GREEN
NMB-1008	RJ-45 MODULAR BOOT - WHITE
NMB-1009	RJ-45 MODULAR BOOT - GRAY
NMB-1010	RJ-45 MODULAR BOOT - ORANGE

MODULAR ADAPTERS

ITEM #	DESCRIPTION
NMA-6109	6C TO DB-9 MALE - GRAY
NMA-6209	6C TO DB-9 FEMALE - GRAY
NMA-6509	6C TO DB-25 MALE - GRAY
NMA-6609	6C TO DB-25 FEMALE - GRAY
NMA-8109	8C TO DB-9 MALE - GRAY
NMA-8209	8C TO DB-9 FEMALE - GRAY
NMA-8309	8C TO DB-15 MALE - GRAY
NMA-8409	8C TO DB-15 FEMALE - GRAY
NMA-8509	8C TO DB-25 MALE - GRAY
NMA-8609	8C TO DB-25 FEMALE - GRAY

For Termination Tools
Please See Pages 56 and 57



4P4C HANDSET

6P4C RJ-11

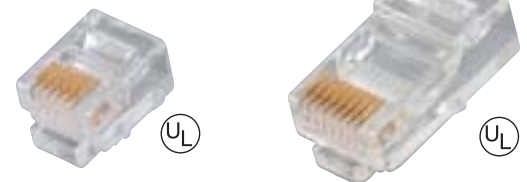

6P6C RJ-12

8P8C RJ-45

Modular Boots



WHITE

GRAY

ORANGE

YELLOW

GREEN

RED

BLUE

BLACK



DB-25 MODULAR ADAPTERS



DB-9 MODULAR ADAPTERS

NETWORK TESTERS



TTE-9030

ITEM #	DESCRIPTION
TTE-9030	REMOTE NETWORK TESTER

The TTE-9030 is a versatile tester that allows installers a quick method of testing patch cables and end-to-end cabling. The unit comes with a slide-out detachable remote module and is designed for testing coax BNC (Ethernet 10Base-2, 10Base-5), RJ-11 (USOC 4/6), RJ-45 (EIA/TIA-568A) and USB cabling. It is packaged with an instruction manual and comes with a fabric case with belt loop.

FEATURES:

- OPEN/SHORT WIRING TEST
- CONNECTED WIRES DISPLAY
- ETHERNET 10BASE-2 TERMINATION VALUE DETECTOR
- PARALLEL/CROSS-WIRING DISPLAY
- AUTOMATIC SHUTOFF
- 9 VOLT BATTERY OPERATION



TTE-9000

ITEM #	DESCRIPTION
TTE-9000	LAN CABLE TESTER

The TTE-9000 LAN Cable Tester enables the installer an easy method to check and identify pin configurations for patch cords and cabling installations. The main unit features an illumination light for visibility in dark work areas. It comes with a remote module, fabric case and 4 test jumper accessories.

FEATURES:

- VERIFY CABLE CONTINUITY, OPEN, SHORT AND MIS-WIRING
- REMOTE MODULE ALLOWS TESTING UP TO 1,000 FEET DISTANCE
- AUTO / MANUAL SCAN FUNCTION
- ILLUMINATION LIGHT
- GROUND WIRE TEST
- 9 VOLT BATTERY OPERATION



TTE-9010

ITEM #	DESCRIPTION
TTE-9010	DATA/VOICE LINK TESTER

The TTE-9010 is an economical tester that allows the testing of modular data and patch cords. It comes with a remote module to allow end-to-end testing for RJ-11 and RJ-45 terminated cables. The test can be selected manually or using the auto-test setting can scan all wires automatically.

FEATURES:

- CHECKS CROSSOVER OR STRAIGHT WIRING
- CHECKS OPEN / SHORT
- REMOTE MODULE INCLUDED
- 9 VOLT BATTERY OPERATION

ITEM #

DESCRIPTION

TTE-9040 TONE GENERATOR & PROBE SET

The TTE-9040 Tone Generator and Probe bring together two great instruments for tracing and identifying wires or cables in a bundle or a group. The tone generator provides a single tone or dual alternating tone and can be used with test leads or RJ-11 4 conductor modular plug for modular jack tests. In addition, the generator utilizes a tri-color LED to identify line polarity, continuity and voltage testing. The amplifier probe works with any existing tone generator and features volume control adjustment. Both units come together in a zippered vinyl protective case.

FEATURES: (TONE GENERATOR)

- SWITCH SELECTABLE TONES
- 3-COLOR LED DISPLAY FOR POLARITY, CONTINUITY AND VOLTAGE.
- TEST LEAD OR MODULAR LINE TESTING
- LOW BATTERY INDICATOR
- 9 VOLT BATTERY OPERATION

FEATURES: (PROBE)

- TRACE AND IDENTIFY WIRES
- VOLUME ADJUSTMENT
- LOW BATTERY INDICATOR
- 9 VOLT BATTERY OPERATION



TTE-9040

ITEM #

DESCRIPTION

TTE-9020 NETWORK INSTALLERS KIT

The TTE-9020 Network Installers Kit comes with everything a network technician needs for small installations and repairs. The kit includes a TTE-9030 Remote Network Tester, TEL-6000 Pro Modular Crimper, TEL-6610 economy UTP stripper, TEL-6090 Pro Impact Punch Down Tool with two blades and 30 pieces of RJ-11 and RJ-45 modular connectors with boots. All in a zippered carrying case.



TTE-9020

FIBER OPTIC CONNECTORS, ADAPTERS, PATCH CORDS



ST CONNECTOR

SC CONNECTOR



ST SIMPLEX



SC SIMPLEX



SC DUPLEX



ST DUPLEX



SC-ST DUPLEX

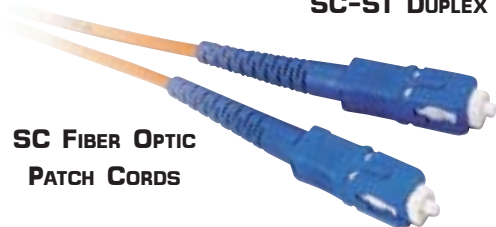

SC FIBER OPTIC PATCH CORDS

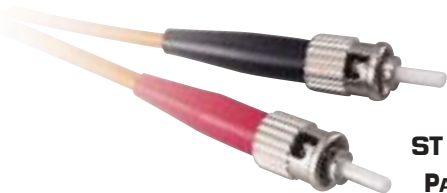

ST FIBER OPTIC PATCH CORDS

As part of QUEST's complete link solutions, we offer a line of reliable fiber optic technology products. Offered are 62.5/125 multimode simplex and duplex fiber connectors and adapters and multimode duplex fiber patch cord jumpers. SC fiber patch cords can be separated for individual connection requirements. Color-coded boots identify jumper connector polarity.

FIBER CONNECTORS

ITEM #	DESCRIPTION
NFO-3000	ST MULTIMODE - 3.0mm WITH BOOT-SIMPLEX
NFO-3001	SC MULTIMODE - 3.0mm WITH BOOT-SIMPLEX
NFO-3002	DUPLEX SC MULTIMODE 3.0mm WITH BOOT

FIBER ADAPTERS

ITEM #	DESCRIPTION
NFO-3021	ST SIMPLEX MULTIMODE FEED-THRU PHOSPHOROUS BRONZE SLEEVE
NFO-3022	ST DUPLEX MULTIMODE FEED-THRU PHOSPHOROUS BRONZE SLEEVE
NFO-3023	SC SIMPLEX MULTIMODE FEED-THRU PHOSPHOROUS BRONZE SLEEVE
NFO-3024	SC DUPLEX MULTIMODE FEED-THRU PHOSPHOROUS BRONZE SLEEVE
NFO-3025	ST TO SC MULTIMODE FEED-THRU PHOSPHOROUS BRONZE SLEEVE

FIBER PATCH CORDS

ITEM #	DESCRIPTION
NFO-3012	ST TO ST M/M DUPLEX - 1 METER
NFO-3013	ST TO ST M/M DUPLEX - 3 METER
NFO-3014	ST TO ST M/M DUPLEX - 5 METER
NFO-3015	SC TO SC M/M DUPLEX - 1 METER
NFO-3016	SC TO SC M/M DUPLEX - 3 METER
NFO-3017	SC TO SC M/M DUPLEX - 5 METER
NFO-3018	ST TO SC M/M DUPLEX - 1 METER
NFO-3019	ST TO SC M/M DUPLEX - 3 METER
NFO-3020	ST TO SC M/M DUPLEX - 5 METER

Please see our Fiber Termination Tool Kit on Page 59

FIBER DISTRIBUTION ENCLOSURES & PANELS

QUEST offers cost-effective enclosure designs to connect and manage 12 to 24 fiber connections. These are offered in wall or rack-mount styles, are compact in design and allow for ease of access to fiber connections. Also offered are fiber trays, which allow for protection to all cables, and fiber optic adapter panels in different configurations, which easily mount inside QUEST enclosures.

WALL-MOUNT ENCLOSURES

ITEM #	DESCRIPTION
NFO-2000	12 PORT ST WALL MOUNT ENCLOSURE
NFO-2001	12 PORT SC WALL MOUNT ENCLOSURE BOTH INCLUDE 2 DUMMY PANELS, 2 ADAPTER PANELS UNLOADED, 1 SPLICE TRAY AND 2 SETS OF FULL MOON CABLE RINGS, WIRE MANAGEMENT KNOCKOUTS AND LOCKING DOOR
NFO-2003	24 PORT ST WALL MOUNT ENCLOSURE
NFO-2004	24 PORT SC WALL MOUNT ENCLOSURE BOTH INCLUDE 4 ADAPTER PANELS UNLOADED, 2 SPLICE TRAYS AND 2 FULL SETS OF CABLE FULL MOON CABLE RINGS

RACK-MOUNT ENCLOSURES

ITEM #	DESCRIPTION
NFO-2006	12 PORT 2 RMS ST RACK MOUNT ENCLOSURE
NFO-2007	12 PORT 2 RMS SC RACK MOUNT ENCLOSURE BOTH INCLUDE 2 ADAPTER PANELS UNLOADED, 1 SPLICE TRAY AND 2 SETS OF FULL MOON CABLE RINGS
NFO-2009	24 PORT 2 RMS ST RACK MOUNT ENCLOSURE
NFO-2010	24 PORT 2 RMS SC RACK MOUNT ENCLOSURE BOTH INCLUDE SOLID MOUNTING RAY FOR INSERTS, 2 SPLICE TRAYS AND 2 SETS OF FULL MOON CABLE RINGS

PANELS AND SPLICE TRAYS

ITEM #	DESCRIPTION
NFO-1006	SPLICE TRAY HOLDS 6 FIBERS
NFO-2012	ST 6 PORT UNLOADED PANEL INSERT
NFO-2013	ST 2x3 PORT DUAL UNLOADED PANEL
NFO-2014	SC 6 PORT UNLOADED PANEL INSERT
NFO-2015	ST 6 PORT LOADED PANEL INSERT
NFO-2016	ST 2x3 PORT DUAL LOADED PANEL
NFO-2017	SC 6 PORT LOADED PANEL INSERT
NFO-2018	SC 2x3 PORT DUAL LOADED PANEL



WALL MOUNT ENCLOSURES



RACK MOUNT ENCLOSURES



FIBER OPTIC ADAPTER PANELS



SPLICE TRAYS

Please see our Fiber Termination Tool Kit on Page 59

SOHO HUBS AND SWITCHES



QUEST provides a diverse selection of SOHO active products to fit most any small office, home office network requirements.

ITEM #	DESCRIPTION
NAP-1005	5 PORT 10Base-T HUB
NAP-1008	8 PORT 10Base-T HUB
NAP-2005	5 PORT 10/100Base-TX DUAL-SPEED HUB
NAP-2008	8 PORT 10/100Base-TX DUAL-SPEED HUB
NAP-3008	8 PORT 10/100Base-TX ETHERNET SWITCH



These palm-sized hubs and switches include applications for 10BaseT, 10BaseT/100BaseTX dual speed hubs and high technology switches. Each unit combines the simplicity of design and operation with advanced functionality and unsurpassed performance.

These units are fully compatible with network operating systems such as Novell, Microsoft, Linux and other leading software systems, and also aid in the compatibility of existing office software and users.

FEATURES:

- FULLY COMPLIES WITH IEEE802.3 & IEEE802.3u STANDARDS.
- BUILT-IN INTERNAL 10Mbps/100Mbps SWITCH ON MODEL NAP-3008
- 10/100Mbps AUTO-DETECT ON DUAL SPEED HUBS AND SWITCHES
- NAP-3008 SUPPORTS FULL DUPLEX OPERATION
- EXTERNAL POWER SUPPLY INCLUDED
- PALM-SIZED SMALL FOOTPRINT DESIGN
- LED INDICATORS FOR NETWORK DIAGNOSIS

DIMENSIONS:

- 7.40" WIDTH
- 3.34" DEPTH
- 2.36" HEIGHT

DESKTOP HUB



ITEM #	DESCRIPTION
NAP-2016	16 PORT DESKTOP 10/100Mbps DUAL SPEED SWITCHING HUB

FEATURES:

- FULLY COMPATIBLE WITH IEEE802.3 & IEEE802.3u STANDARDS
- BUILT-IN POWER SUPPLY
- DESKTOP DESIGN
- 10/100Mbps AUTO-DETECT
- LED INDICATORS FOR NETWORK DIAGNOSIS



NETWORK INTERFACE CARDS

The QUEST TECHNOLOGY Network Interface Cards deliver fast, reliable performance and ease of installation with a broad range of compatibility. QUEST NIC cards support all major BUS types and driver support.

ITEM #	DESCRIPTION
NAP-4010	10BaseT PCI BUS ETHERNET ADAPTER
NAP-4110	10/100Base-TX FAST ETHERNET ADAPTER (BNC, RJ-45 UTP/STP)

FEATURES:

- PCI INTERFACE
- 10BaseT OR 10/100Base-TX MODELS AVAILABLE
- MODEL NAP-4110 IS SUN PC-NFJ COMPATIBLE



NIC SUPPORT

SUPPORTED DRIVERS:

- Netware client/server 3.x/4.x
- Windows 95/98
- Windows NT
- Windows 2000
- Packet Driver
- LAN Server 2/3/4.x
- SCO UNIX 4.x/5.x
- Lantastic 6.0
- Linux

RACK MOUNT HUBS AND SWITCHES

**3-Year
Warranty**



RACK MOUNT SWITCHES



RACK MOUNT HUB

QUEST TECHNOLOGY's 10/100Mbps auto-sensing rack-mount switches provide users with high-speed network connections and a choice of console management via its RS-232 console port. High quality solutions at affordable prices, enabling the most budget conscious organizations to trade up to the next level of networking power.

RACK-MOUNT SWITCHES

ITEM #	DESCRIPTION
NAP-3016	16 PORT 10/100Base-TX RACK - MOUNT FAST ETHERNET SWITCH
NAP-3024	24 PORT 10/100Base-TX RACK - MOUNT SMART SWITCH

FEATURES:

- COMPLIES WITH 10Base-T, 100Base-TX, 100Base-FX
- HIGH PERFORMANCE STORE & FORWARD SWITCHING TECHNOLOGY
- AUTO-NEGOTIATION 10/20Mbps - 100/200Mbps
- FULL DUPLEX SUPPORTED, HALF DUPLEX FLOW CONTROL
- SWITCHING FABRIC: 4.2 Gbps
- 64K DATA BUFFER PER PORT
- RUN & CRC FILTERING ELIMINATES ERRONEOUS PACKETS TO OPTIMIZE NETWORK BANDWIDTH
- NAP-3024 SUPPORTS VLAN & PORT-TRUNKING
- PLUG & PLAY OPERATION

RACK-MOUNT HUB

ITEM #	DESCRIPTION
NAP-2024	100Base-TX DUAL SPEED RACK - MOUNT HUB

FEATURES:

- COMPLIES WITH 10Base-T, 100Base-TX, 100Base-FX
- AUTO 10Mbps/100Mbps SEGMENT SWITCHING INTERNALLY
- SUPPORTS "BAD PORT" PARTITIONING AUTOMATICALLY

MEDIA CONVERTER

ITEM #

DESCRIPTION

NAP-5012 10Base2 TO 10Base-T MEDIA CONVERTER

The NAP-5012 is a 10Base-2 to 10Base-T converter that formats the 10Base2 to a 10Base-T protocol converting to UTP (twisted pair) on coax LAN'S. On the UTP side QUEST uses a modular EIA/TIA 568 RJ-45 connector that supports CAT3/4/5 wiring and connects at a distance of up to 100 meters (328 feet). On the coax side QUEST utilizes a BNC connector and supports 50 Ohm cabling at a distance of up to 185 meters (606 feet)



MEDIA CONVERTER

TRANSCEIVER

ITEM #

DESCRIPTION

NAP-5015 ETHERNET AUI TO UTP TRANSCEIVER

QUEST Ethernet transceivers supports all transceiver MAU functions as specified by the IEEE802.3 standards. The transceiver operates on 5VDC, 1A max.



TRANSCEIVER

ETHERNET FIBER CONVERTERS

ITEM #

DESCRIPTION

- NAP-4120 100Base-FX PCI TO ST FIBER CONVERTER
- NAP-4130 100Base-FX PCI TO SC FIBER CONVERTER

QUEST TECHNOLOGY's fast Ethernet converters formats 100Base-FX to a 100Base-FX fiber optic transmission protocol. These are designed to support half and full duplex operations for either SC or ST interface.



FIBER CONVERTERS



RACEWAY SYSTEMS

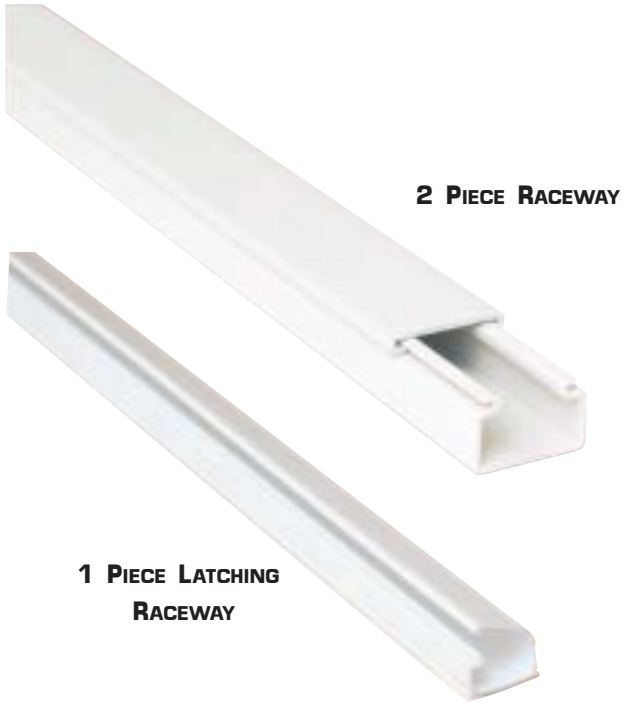

2 PIECE RACEWAY

1 PIECE LATCHING RACEWAY

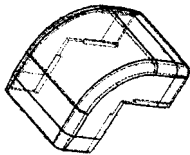

OUTSIDE CORNER

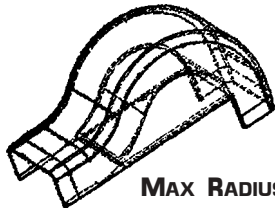

MAX RADIUS OUTSIDE CORNER

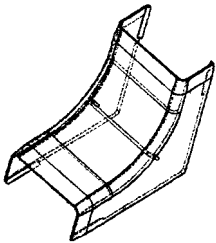

INSIDE CORNER

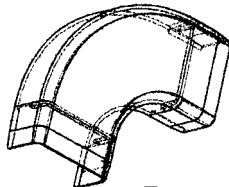

ELBOW

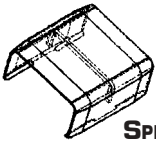

SPLICE

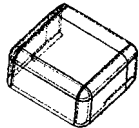

CAP

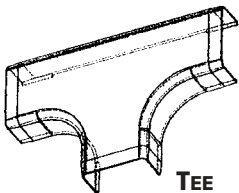

TEE

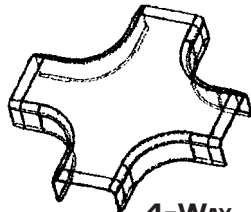

4-WAY JUNCTION



JUNCTION BOX

QUEST's raceway system offers installer-friendly one-piece latching and 2-piece duct raceway and accessories to facilitate the routing of cables in open architecture wiring. The raceway is manufactured with flame-retardant material and is easily cut and painted to match any décor.

Raceway can be used for many low-voltage applications including Data UTP, STP, Coaxial, Fiber Optic, Signal, Audio, Video and others. The raceway is manufactured with high-strength adhesive tape backing for ease of installation and come in 6 foot lengths in 0.5" and 1" widths. A comprehensive line of accessories is also available, including an outside corner designed for fiber optic and CAT5 bend radius requirements.

All raceway and accessories come in white.

ITEM #	DESCRIPTION
NRS-1805	0.5" 1PC. LATCHING RACEWAY, 6' LENGTH, 10/BOX, WHITE
NRS-1801	1" 1PC. LATCHING RACEWAY, 6' LENGTH, 10/BOX, WHITE
NRS-2805	0.5" 2-PC. RACEWAY, 6' LENGTH, 10/BOX, WHITE
NRS-2801	1" 2-PC. RACEWAY, 6' LENGTH, 10/BOX, WHITE
NRS-3005	0.5" SPLICE, 10/BAG WHITE
NRS-3001	1" SPLICE, 10/BAG WHITE
NRS-3015	0.5" CAP, 10/BAG WHITE
NRS-3011	1" CAP, 10/BAG WHITE
NRS-3025	0.5" TEE, 10/BAG WHITE
NRS-3021	1" TEE, 10/BAG WHITE
NRS-3035	0.5" ELBOW, 10/BAG WHITE
NRS-3031	1" ELBOW, 10/BAG WHITE
NRS-3045	0.5" INSIDE CORNER, 10/BAG WHITE
NRS-3041	1" INSIDE CORNER, 10/BAG WHITE
NRS-3055	0.5" OUTSIDE CORNER, 10/BAG WHITE
NRS-3051	1" OUTSIDE CORNER, 10/BAG WHITE
NRS-3095	0.5" MAX RADIUS OUTSIDE CORNER, 10/BAG, WHITE
NRS-3091	1" MAX RADIUS OUTSIDE CORNER, 10/BAG, WHITE
NRS-4005	0.5" 4-WAY JUNCTION, 10/BAG WHITE
NRS-4001	1" 4-WAY JUNCTION, 10/BAG WHITE
NRS-3062	UNIVERSAL JUNCTION BOX, 1/BAG

CABLE TIES AND STRAPS

QUEST offers high quality and affordable wire management hook and loop fasteners for most any wire retention applications. The QUEST hook and loop ties feature a unique bonding design to assure high durability under extreme use allowing excellent repetitive peel characteristics. The high retention hook and loop design maintains a firm grip even under high cable stress and under high temperature exposure. Additionally, QUEST offers a selection of high quality nylon cable ties in an assortment of sizes.

HOOK - LOOP FASTENERS

ITEM #	DESCRIPTION
NVT-0321	1"x2" PSA PADS - BLACK
NVT-0191	1"x9" HOOK/LOOP FASTENER - BLACK
NVT-0192	1"x9" HOOK/LOOP FASTENER - BLUE
NVT-0193	1"x9" HOOK/LOOP FASTENER - RED
NVT-1131	1"x13" HOOK/LOOP FASTENER - BLACK
NVT-1132	1"x13" HOOK/LOOP CABLE TIE - BLUE
NVT-1133	1"x13" HOOK/LOOP CABLE TIE - RED
NVT-3461	3/4"x6" HOOK/LOOP CABLE TIE - BLACK
NVT-3801	3/8"x10 YARDS HOOK/LOOP ROLL - BLACK
NVT-3802	3/8"x10 YARDS HOOK/LOOP ROLL - BLUE
NVT-3803	3/8"x10 YARDS HOOK/LOOP ROLL - RED
NVT-3401	3/4"x10 YARDS HOOK/LOOP ROLL - BLACK
NVT-3402	3/4"x10 YARDS HOOK/LOOP ROLL - BLUE
NVT-3403	3/4"x10 YARDS HOOK/LOOP ROLL - RED
NVT-1201	3/4"x12" CINCH STRAP - BLACK
NVT-1801	3/4"x18" CINCH STRAP - BLACK
NVT-1101	1"x10" EYELET CINCH STRAP - BLACK
NVT-1130	1"x13" EYELET CINCH STRAP - BLACK

NYLON WIRE TIES

ITEM #	DESCRIPTION
NWT-4210	4" NYLON MARKET TIE, 18lb., WHITE
NWT-8041	4" UV NYLON CABLE TIE, 18lb., BLACK
NWT-8048	4" NYLON CABLE TIE, 18lb., WHITE
NWT-4200	8" NAILABLE NYLON TIE, 40lb., WHITE
NWT-4081	8" UV NYLON CABLE TIE, 40lb., BLACK
NWT-4088	8" NYLON CABLE TIE, 40lb., WHITE
NWT-8081	8" UV NYLON CABLE TIE, 18lb., BLACK
NWT-8088	8" NYLON CABLE TIE, 18lb., WHITE
NWT-4111	11" UV NYLON CABLE TIE, 40lb., BLACK
NWT-4118	11" NYLON CABLE TIE, 40lb., WHITE
NWT-4141	14" UV NYLON CABLE TIE, 40lb., BLACK
NWT-4148	14" NYLON CABLE TIE, 40lb., WHITE



HOOK/LOOP ROLLS



HOOK/LOOP CINCH STRAP

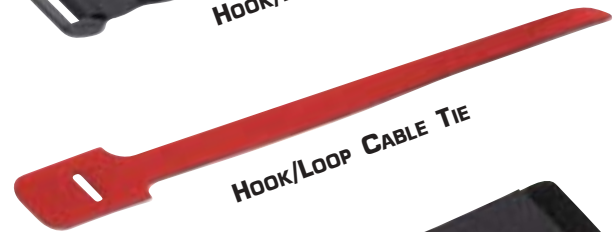

HOOK/LOOP CABLE TIE



EYELET CINCH STRAP



PSA PAD



NYLON WIRE TIES

RELAY RACKS AND CABINETS



7' ALUMINUM RACK



7' BLACK ALUMINUM RACK



4' ALUMINUM RACK



4' BLACK ALUMINUM RACK

Ref #	RMS	Height	A	B	C	D	E
NWM-0401	24	4'	5"	18 5/16"	48"	14"	21"
NWM-0402			127 mm	465 mm	1219 mm	356 mm	533 mm
NWM-0701	45	7'	5"	18 5/16"	84"	14"	21"
NWM-0702			127 mm	465 mm	2134 mm	356 mm	533 mm

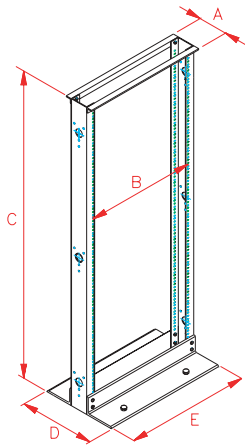

EQUIPMENT CABINET

QUEST provides only the best quality wire management products designed for mounting equipment and hardware. The 19" relay racks are offered in 4 and 7-foot heights and in natural aluminum and powder-coat electrostatic black finish. All racks are provided with all assembly hardware including equipment screws. They are designed with mounting holes for anchoring rack to the floor.

FEATURES AND BENEFITS:

- FABRICATED WITH TOP GRADE ALUMINUM
- 12-24 THREADED RAILS ON BOTH SIDES
- DOUBLE ROLLED TOP CROSS BRACES FOR ADDED STABILITY
- ASSEMBLY HARWARE INCLUDED
- EQUIPMENT SCREWS INCLUDED
- EASY TO ASSEMBLE

RACKS

ITEM #	DESCRIPTION
--------	-------------

NWM-0401	19" x 48" RACK - ALUMINUM FINISH 24 RMS CAPACITY
NWM-0402	19" x 48" RACK - BLACK POWDERCOAT FINISH 24 RMS CAPACITY
NWM-0701	19" x 84" RACK - ALUMINUM FINISH 45 RMS CAPACITY
NWM-0702	19" x 84" RACK - BLACK POWDERCOAT FINISH 45 RMS CAPACITY

QUEST also offers floor standing aluminum equipment cabinets. These cabinets feature a modular design concept, which allows custom installation options such as ventilation fans, mutli-outlet electrical strips, wire managers and others.

Additionally the interior placement of equipment can be tailored for each installation requirement and allow easy front or rear access. The cabinets are offered in black-powder electrostatic finish as well as natural ivory.

CABINETS

ITEM #	DESCRIPTION
--------	-------------

NWM-4000	48" CABINET - IVORY
NWM-4001	48" CABINET - BLACK

In structured wiring installations, proper cable management is essential. QUEST offers cable management products that complement our line of 19" racks and wall mount brackets. These cable managers are offered in single and double row designs featuring high-strength plastic rings and are compliant with EIA/TIA recommendations.

Our wall mount brackets are designed with a hinged side that facilitates pre-wiring prior to securing to wall mount environments. They are manufactured with high quality steel and are finished in black.

FEATURES: (CABLE MANAGERS)

- ALUMINUM BASE PLATE MATERIAL
- ROLLED METAL CONSTRUCTION
- BLACK ELECTROSTATIC FINISH
- FLEXIBLE, HIGH-DURABILITY NYLON RINGS

FEATURES: (WALL BRACKETS)

- HINGED ARM DESIGN
- 2,4 AND 6 RMS SIZES
- 14 GAUGE STEEL CONSTRUCTION
- BLACK ELECTROSTATIC FINISH

CABLE MANAGERS

ITEM #	DESCRIPTION
--------	-------------

NWM-2001	19" HORIZONTAL WIRE MANAGER 5 PLASTIC RINGS - 1 RMS
NWM-2002	19" HORIZONTAL WIRE MANAGER 10 PLASTIC RINGS - 2 RMS

WALL BRACKETS

ITEM #	DESCRIPTION
--------	-------------

NWM-3002	19" HINGED WALL BRACKET - 2 RMS
NWM-3004	19" HINGED WALL BRACKET - 4 RMS
NWM-3006	19" HINGED WALL BRACKET - 6 RMS

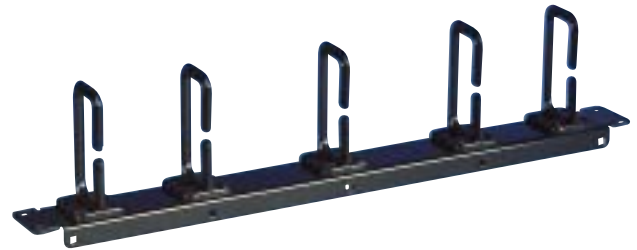

SINGLE 5 RING MANAGER



DUAL 10 RING MANAGER



HINGED WALL BRACKET



SINGLE SOLID SHELF

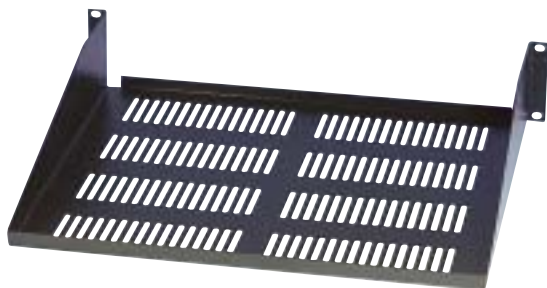

SINGLE VENTED SHELF



SINGLE SLIDE-OUT SHELF



DUAL SOLID SHELF

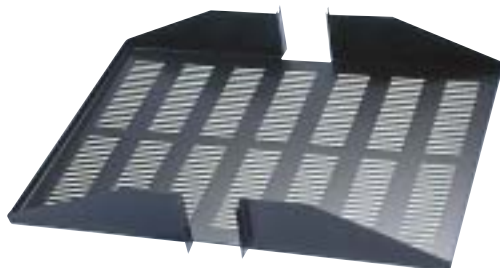

DUAL VENTED SHELF

QUEST offers solid and vented 19" equipment shelves and trays for mounting telecommunication devices in 19" racks or cabinets. The vented designs offer added thru-airflow for assisting equipment to dissipate operational heat. They are offered in single or double sided, vented or non-vented, slide-out vented designs that conform to EIA specifications for 19" racks and cabinets. They are manufactured with 16-gauge steel and are painted in black powder electrostatic finish with rolled edges to prevent equipment slippage. Mounting hardware is included.

QUEST also offers a 19" keyboard tray with mouse wing attachment that is reversible for right or left-handed use. The tray mounts in a 1 RMS space and is rolled to prevent keyboard slippage. Manufactured to support up to 52 pounds. Mounting hardware is included.

ITEM #

DESCRIPTION

NWM-1011	19" SINGLE-SIDED NON-VENTED SHELF 2 RMS - 56 LB. CAPACITY
NWM-1021	19" SINGLE-SIDED VENTED SHELF 2 RMS - 56 LB. CAPACITY
NWM-1032	19" SINGLE-SIDED SLIDE-OUT VENTED SHELF 2 RMS - 48 LB. CAPACITY
NWM-1012	19" DOUBLE-SIDED NON - VENTED SHELF 3 RMS - 70 LB. CAPACITY
NWM-1022	19" DOUBLE - SIDED VENTED SHELF 3 RMS - 70 LB. CAPACITY
NWM-1000	19" KEYBOARD SHELF WITH REVERSIBLE MOUSE TRAY - 1 RMS - 52 LB. CAPACITY



KEYBOARD SHELF

DIMENSIONAL SPECIFICATIONS

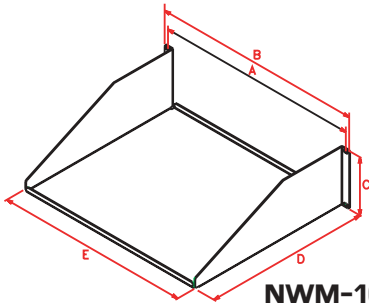

NWM-1011

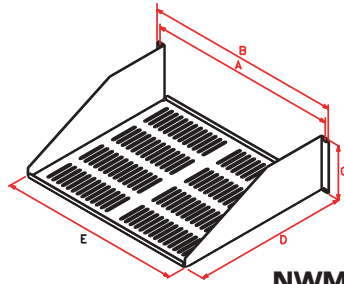

NWM-1021

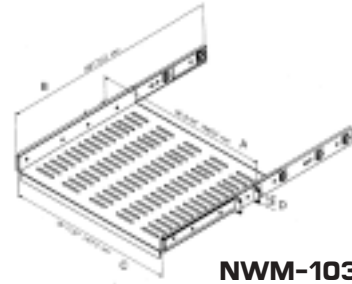

NWM-1032

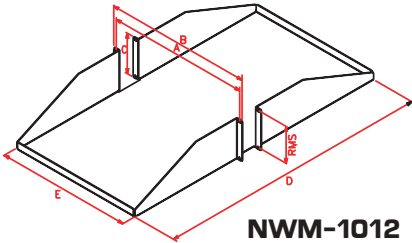

NWM-1012

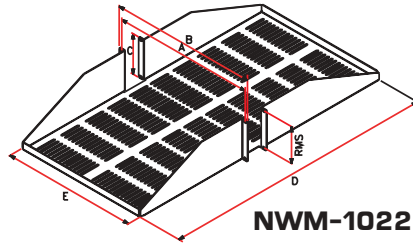

NWM-1022

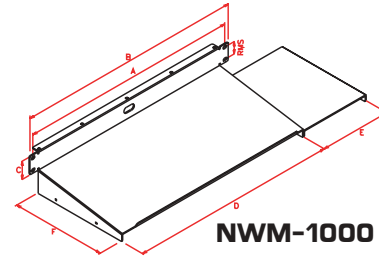

NWM-1000

Item #	RMS	A	B	C	D	E	F	Max Load
NWM-1011	1	18 5/16"	19"	1 3/4"	15"	17 1/2"	N/A	70 lbs
		465 mm	483 mm	44 mm	381 mm	444 mm		25 Kg
NWM-1021	1	18 5/16"	19"	1 3/4"	15"	17 1/2"	N/A	70 lbs
		465 mm	483 mm	44 mm	381 mm	444 mm		25 Kg
NWM1032	1	18 5/16"	28"	18 5/16"	1 3/4"	N/A	N/A	48 lbs
		465 mm	711 mm	465 mm	44 mm			14 Kg
NWM-1012	2	18 5/16"	19"	3 1/2"	15"	17 1/2"	N/A	96 lbs
		465 mm	483 mm	89 mm	381 mm	444 mm		48 kg
NWM-1022	2	18 5/16"	19"	3 1/2"	15"	17 1/2"	N/A	88 lbs
		465 mm	483 mm	89 mm	381 mm	444 mm		44 Kg
NWM-1000	1	18 5/16"	19"	1 3/4"	17 7/16"	5 3/4"	8"	52 lbs
		465 mm	483 mm	44 mm	443 mm	146 mm	203 mm	26 Kg

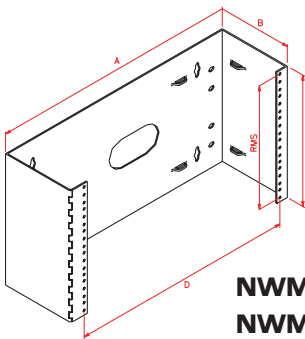

NWM-3002
NWM-3004
NWM-3006

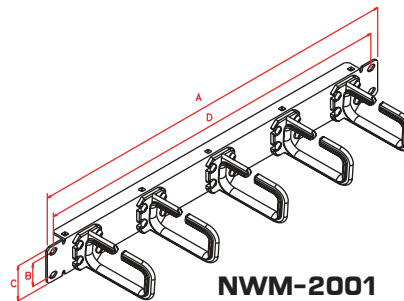

NWM-2001

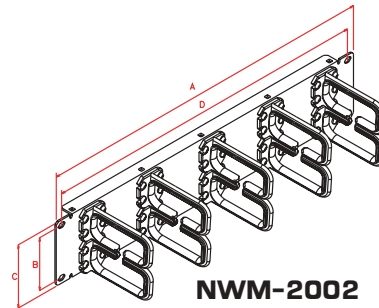

NWM-2002

Item #	RMS	A	B	C	D	Rings		
						#	Material	Capacity
NWM-3002	2	20"/508 mm	6"/152 mm	3 1/2" / 89 mm	18 5/16" / 465 mm		N/A	
NWM-3004	4	20"/508 mm	6"/152 mm	7"/118 mm	18 5/16" / 465 mm		N/A	
NWM-3006	6	20"/508 mm	6"/152 mm	10 1/2"/267 mm	18 5/16" / 465 mm		N/A	
NWM-2001	1	19"/483 mm	1 1/4"/44 mm	13/4"/44 mm	18 5/16" / 465 mm	5	NYLON	50 CABLE
NWM-2002	2	19"/483 mm	3"/76 mm	3 1/2"/89 mm	18 5/16" / 465 mm	10	NYLON	100 CABLE

WIRE MANAGEMENT

TELEPHONE WALL PLATES



**SMOOTH FINISH
IVORY**



**SMOOTH FINISH
WHITE**



**DUAL SMOOTH
IVORY**



**DUAL SMOOTH
WHITE**

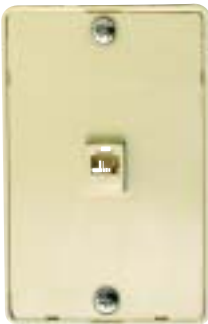

**WALL - PHONE
IVORY**



**WALL - PHONE
WHITE**



**COMBO RJ11/F-81
IVORY**



**COMBO RJ11/F-81
WHITE**

QUEST offers a broad selection of telephone faceplates featuring screw terminals for ease of installation. These faceplates are designed to be mounted into any standard single gang electrical box or can be mounted into QUEST's single gang junction box. The faceplates are offered exclusively with smooth face designs in white or ivory and for wall mounted telephones. The telephone faceplates come in 6 position 4 and 6 conductor and in 8 position, 8 conductor single and dual outlet. Also offered is the combination telephone/video outlet faceplate now commonly used for residential satellite hook-ups. All wall plates come with mounting screws.

ITEM #	DESCRIPTION
NTP-2401	4 CONDUCTOR WALLPLATE 1 OUTLET - IVORY
NTP-2402	4 CONDUCTOR WALLPLATE 1 OUTLET - WHITE
NTP-1441	DUAL OUTLET 4 CONDUCTOR WALLPLATE - IVORY
NTP-1442	DUAL OUTLET 4 CONDUCTOR WALLPLATE - WHITE
NTP-1601	6 CONDUCTOR WALLPLATE 1 OUTLET - IVORY
NTP-1602	6 CONDUCTOR WALLPLATE 1 OUTLET - WHITE
NTP-1661	DUAL OUTLET 6 CONDUCTOR WALLPLATE - IVORY
NTP-1662	DUAL OUTLET 6 CONDUCTOR WALLPLATE - WHITE
NTP-1801	8 CONDUCTOR WALLPLATE 1 OUTLET - IVORY
NTP-1802	8 CONDUCTOR WALLPLATE 1 OUTLET - WHITE
NTP-1881	DUAL OUTLET 8 CONDUCTOR WALLPLATE - IVORY
NTP-1882	DUAL OUTLET 8 CONDUCTOR WALLPLATE - WHITE
NTP-4401	4 CONDUCTOR WALL - PHONE PLATE - IVORY
NTP-4402	4 CONDUCTOR WALL - PHONE PLATE - WHITE
NTP-1901	COMBO 4 COND/F CONNECTOR WALLPLATE - IVORY
NTP-1902	COMBO 4 COND/F CONNECTOR WALLPLATE - WHITE

TELEPHONE SURFACE MOUNT BOXES & ADAPTERS

For surface mounting and line coupling applications, QUEST offers a wide assortment of surface mount boxes, couplers and adapters. Most models are offered in single and dual outlet, in ivory and white. The surface mount boxes are packaged with mounting screws and double-sided adhesive tape.

ITEM # **DESCRIPTION**

NTB-1401	4C SINGLE SURFACE BOX - IVORY
NTB-1402	4C SINGLE SURFACE BOX - WHITE
NTB-2401	4C DUAL SURFACE BOX - IVORY
NTB-2402	4C DUAL SURFACE BOX - WHITE
NTB-3401	4C SINGLE LOW PROFILE STYLE SURFACE BOX - IVORY
NTB-3402	4C SINGLE LOW PROFILE STYLE SURFACE BOX - WHITE
NTB-1601	6C SINGLE SURFACE BOX - IVORY
NTB-1602	6C SINGLE SURFACE BOX - WHITE
NTB-3601	6C SINGLE LOW PROFILE STYLE SURFACE BOX - IVORY
NTB-3602	6C SINGLE LOW PROFILE STYLE SURFACE BOX - WHITE
NTB-1801	8C SINGLE SURFACE BOX - IVORY
NTB-1802	8C SINGLE SURFACE BOX - WHITE
NTC-1421	4C IN-LINE TEL. COUPLER - IVORY
NTC-1422	4C IN-LINE TEL. COUPLER - WHITE
NTC-1621	6C IN-LINE TEL. COUPLER - IVORY
NTC-1622	6C IN-LINE TEL. COUPLER - WHITE
NTC-1821	8C IN-LINE TEL. COUPLER - IVORY
NTC-1822	8C IN-LINE TEL. COUPLER - WHITE
NTC-2421	4C DUPLEX ADAPTER - IVORY
NTC-2422	4C DUPLEX ADAPTER - WHITE
NTC-2621	6C DUPLEX ADAPTER - IVORY
NTC-2622	6C DUPLEX ADAPTER - WHITE
NTC-2821	8C DUPLEX ADAPTER - IVORY
NTC-2822	8C DUPLEX ADAPTER - WHITE



**SINGLE SURFACE BOX
IVORY**



**SINGLE SURFACE BOX
WHITE**



**LOW PROFILE
SURFACE BOX - IVORY**



**LOW PROFILE
SURFACE BOX - WHITE**



**DUAL SURFACE BOX
IVORY**



**DUAL SURFACE BOX
WHITE**



**DUPLEX ADAPTER
IVORY**



**DUPLEX ADAPTER
WHITE**



**IN-LINE COUPLER
IVORY**



**IN-LINE COUPLER
WHITE**

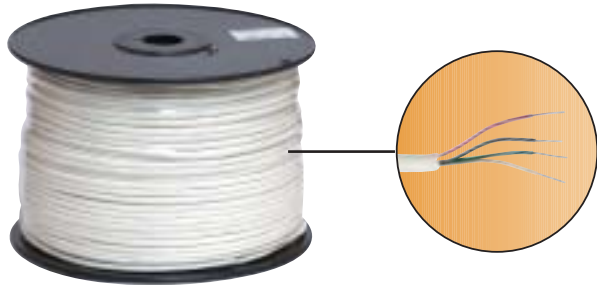

ROUND SOLID CABLE

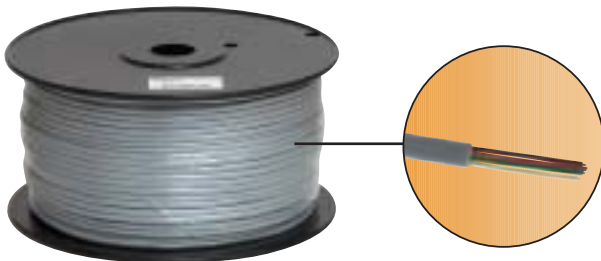

FLAT STRANDED CABLE



4C MODULAR TELEPHONE PATCH CORD



6C MODULAR TELEPHONE PATCH CORD



8C MODULAR TELEPHONE PATCH CORD

QUEST offers telephone and data cables in reels for cabling installations and for cable assembly manufacturing. Featured are voice grade cables in round solid type for hardwiring and flat stranded silver satin for cable assemblies. In addition, QUEST offers CAT5e 100MHZ and CAT5e 350MHZ UTP solid cable for structured wiring installations. Bulk cable is sold in 1,000-foot put-ups.

QUEST also offers pre-assembled silver satin modular patch cords in 4, 6 and 8 conductors and in various lengths. The modular cords are cross-wired for telephone use.

BULK CABLE

ITEM #	DESCRIPTION
NBW-1426	2PR. (4C) 24AWG ROUND SOLID TEL. CABLE - 1,000'
NBW-1626	3PR. (6C) 24AWG ROUND SOLID TEL. CABLE - 1,000'
NBW-1826	4PR. (8C) 24AWG ROUND SOLID TEL. CABLE - 1,000'
NBW-2428	4C 28AWG FLAT SILVER SATIN TEL. CABLE - 1,000'
NBW-2628	6C 28AWG FLAT SILVER SATIN TEL. CABLE - 1,000'
NBW-2828	8C 28AWG FLAT SILVER SATIN TEL. CABLE - 1,000'
NBW-1050	4P CAT5E 100MHZ SOLID UTP 24AWG 1,000'
NBW-1051	4P CAT5E 350MHZ SOLID UTP 24AWG 1,000'

PATCH CORDS

ITEM #	DESCRIPTION
NCO-4107	4C-7FT. TEL. CORD SILVER SATIN
NCO-4115	4C-15FT. TEL. CORD SILVER SATIN
NCO-4125	4C-25FT. TEL. CORD SILVER SATIN
NCO-6207	6C-7FT. TEL. CORD SILVER SATIN
NCO-6215	6C-15FT. TEL. CORD SILVER SATIN
NCO-6225	6C-25FT. TEL. CORD SILVER SATIN
NCO-8307	8C-7FT. TEL. CORD SILVER SATIN
NCO-8315	8C-15FT. TEL. CORD SILVER SATIN
NCO-8325	8C-25FT. TEL. CORD SILVER SATIN

D-SUB GENDER CHANGERS SWITCH BOXES

In addition to D-subminiature connectors and computer cables, QUEST offers gender adapters, which allow changes in gender configurations and pin count sizes. QUEST also offers data switch boxes for RS-232 applications in manual and automatic designs.

GENDER ADAPTERS

ITEM #	DESCRIPTION
NGC-1022	D9 FEMALE TO D9 FEMALE SLIMLINE GENDER ADAPTER
NGC-1011	D9 MALE TO D9 MALE SLIMLINE GENDER ADAPTER
NGC-1044	D15 FEMALE TO D15 FEMALE SLIMLINE GENDER ADAPTER
NGC-1033	D15 MALE TO D15 MALE SLIMLINE GENDER ADAPTER
NGC-1066	D25 FEMALE TO D25 FEMALE SLIMLINE GENDER ADAPTER
NGC-1055	D25 MALE TO D25 MALE SLIMLINE GENDER ADAPTER
NGC-2216	D9 MALE TO D25 FEMALE GENDER ADAPTER
NGC-2225	D9 FEMALE TO D25 MALE GENDER ADAPTER
NGC-2257	D25 MALE TO 36 PIN MALE CENTRONICS ADAPTER

DATA SWITCH BOXES

ITEM #	DESCRIPTION
NGC-3020	D25 RS-232 A-B DATA SWITCH BOX
NGC-3040	D25 RS-232 AUTOMATIC A-B DATA SWITCH BOX



D9 FEMALE-D9 FEMALE



D9 MALE-D9 MALE



D15 FEMALE-D15 FEMALE



D15 MALE-D15 MALE



D25 FEMALE-D25 FEMALE



D25 MALE-D25 MALE



D9 MALE-D25 FEMALE



D9 FEMALE-D25 MALE



D25 A-B Auto Switch Box



D25 A-B Switch Box



D25 MALE-36 P CENTRONICS

COMPUTER DATA CABLES

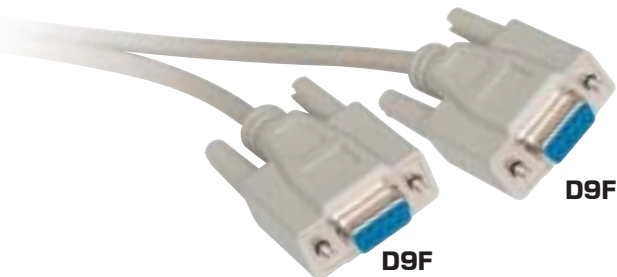
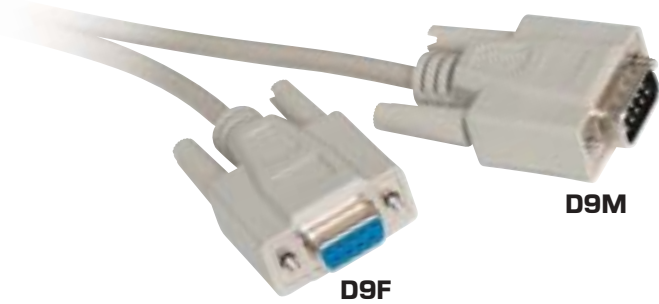

QUEST offers a quality line of the most popular molded computer cable assemblies used for broadcast, audio, instrumentation and computer EIA RS-232 applications. The cables are constructed with high-quality materials and are warranted for life. The cable lineup includes printer cables, RS232 25 pin, RS232 9 pin, 36 pin Centronics, VGA in various lengths and configurations. All are fully shielded.

FEATURES:

- ALUMINUM MYLAR SHIELD
- TINNED COPPER DRAIN WIRE
- TINNED STRANDED COPPER CONDUCTORS
- MOLDED WITH THUMBSCREWS
- PVC JACKET
- LIFETIME WARRANTY

ITEM # DESCRIPTION

NCC-7706	6' 36P CENTRONICS MALE TO 36P CENTRONICS MALE
NCC-7710	10' 36P CENTRONICS MALE TO 36P CENTRONICS MALE
NCC-7725	25' 36P CENTRONICS MALE TO 36P CENTRONICS MALE
NCC-5606	6' D25 MALE TO D25 FEMALE
NCC-5610	10' D25 MALE TO D25 FEMALE
NCC-5625	25' D25 MALE TO D25 FEMALE
NCC-5506	6' D25 MALE TO D25 MALE
NCC-5510	10' D25 MALE TO D25 MALE
NCC-5525	25' D25 MALE TO D25 MALE
NCC-1206	6' D9 MALE TO D9 FEMALE
NCC-1210	10' D9 MALE TO D9 FEMALE
NCC-2206	6' D9 FEMALE TO D9 FEMALE
NCC-2210	10' D9 FEMALE TO D9 FEMALE
NCC-1106	6' D9 MALE TO D9 MALE
NCC-1110	10' D9 MALE TO D9 MALE



As a continuation of the computer cable selection, QUEST offers other cable assemblies, such as IEEE printer cables that conform to IEEE1284 specifications for high-speed bi-directional data transfer. Also high-density models for VGA applications are offered in various lengths.

FEATURES:

- ALUMINUM MYLAR SHIELD
- TINNED COPPER DRAIN WIRE
- TINNED STRANDED COPPER CONDUCTORS
- MOLDED WITH THUMBSCREWS
- PVC JACKET
- GOLD PLATED PINS
- MOLDED STRAIN RELIEF
- CONNECTOR GROUND INDENTS
- LIFETIME WARRANTY



ITEM #	DESCRIPTION
NCC-5206	6' D25 MALE TO D9 FEMALE
NCC-5210	10' D25 MALE TO D9 FEMALE
NCC-2910	10' D9 MALE TO D15 HIGH DENSITY MALE
NCC-9906	6' D15 HIGH DENSITY MALE TO D15 HIGH DENSITY MALE
NCC-9910	10' D15 HIGH DENSITY MALE TO D15 HIGH DENSITY MALE
NCC-9006	6' D15 HIGH DENSITY MALE TO D15 HIGH DENSITY FEMALE
NCC-9010	10' D15 HIGH DENSITY MALE TO D15 HIGH DENSITY FEMALE
NCC-5706	6' D25 MALE TO 36 PIN CENTRONICS PRINTER CABLE 25 CONDUCTORS
NCC-5710	10' D25 MALE TO 36 PIN CENTRONICS PRINTER CABLE 25 CONDUCTORS
NCC-5725	25' D25 MALE TO 36 PIN CENTRONICS PRINTER CABLE 25 CONDUCTORS
NCC-4006	6' IEEE D25 MALE TO 36 PIN CENTRONICS PRINTER CABLE 25 CONDUCTORS
NCC-4010	10' IEEE D25 MALE TO 36 PIN CENTRONICS PRINTER CABLE 25 CONDUCTORS

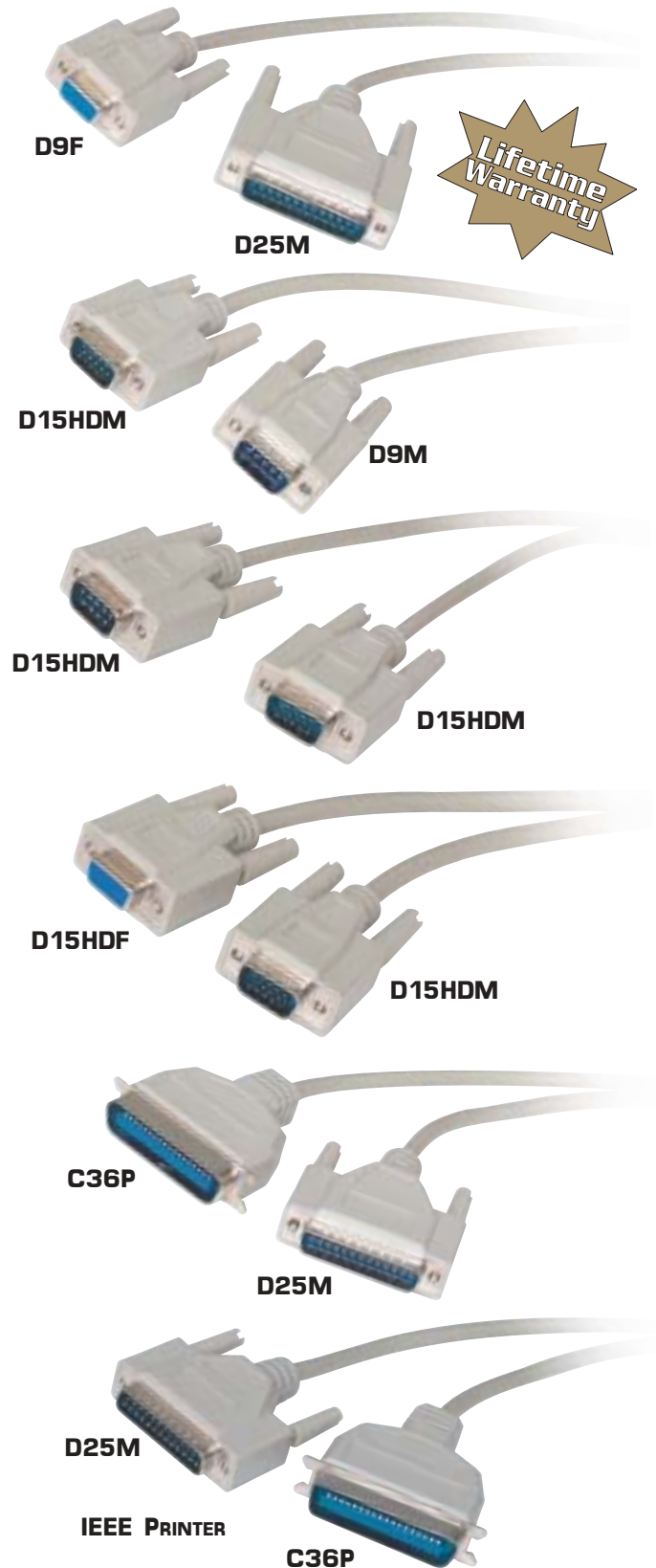

D-SUBMINIATURE CONNECTORS



SOLDER MALE



SOLDER FEMALE



CRIMP MALE

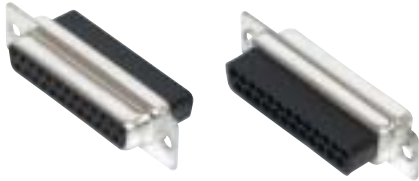

CRIMP FEMALE



HI-DENSITY MALE SOLDER



HI-DENSITY FEMALE SOLDER



HI-DENSITY MALE CRIMP



HI-DENSITY FEMALE CRIMP

QUEST offers a comprehensive selection of D-subminiature connectors for use in serial and parallel port connections. These products are used in various applications requiring multi-conductor connectivity primarily for instrumentation and computer interconnect. QUEST offers them in solder and crimp styles in most pin configurations, male and female genders.

SOLDER STYLE

ITEM #	DESCRIPTION
DSC-1109	9 PIN SOLDER D-SUB MALE
DSC-1209	9 PIN SOLDER D-SUB FEMALE
DSC-1115	15 PIN SOLDER D-SUB MALE
DSC-1215	15 PIN SOLDER D-SUB FEMALE
DSC-1125	25 PIN SOLDER D-SUB MALE
DSC-1225	25 PIN SOLDER D-SUB FEMALE
DSC-1137	37 PIN SOLDER D-SUB MALE
DSC-1237	37 PIN SOLDER D-SUB FEMALE
DSC-1150	50 PIN SOLDER D-SUB MALE
DSC-1250	50 PIN SOLDER D-SUB FEMALE
DSC-3109	15 PIN HIGH-DENSITY SOLDER D-SUB MALE
DSC-3209	15 PIN HIGH-DENSITY SOLDER D-SUB FEMALE
DSC-3126	26 PIN HIGH-DENSITY SOLDER D-SUB MALE
DSC-3226	26 PIN HIGH-DENSITY SOLDER D-SUB FEMALE

CRIMP STYLE

ITEM #	DESCRIPTION
DSC-2109	9 PIN CRIMP D-SUB MALE
DSC-2209	9 PIN CRIMP D-SUB FEMALE
DSC-2115	15 PIN CRIMP D-SUB MALE
DSC-2215	15 PIN CRIMP D-SUB FEMALE
DSC-2125	25 PIN CRIMP D-SUB MALE
DSC-2225	25 PIN CRIMP D-SUB FEMALE
DSC-4115	15 PIN HIGH-DENSITY CRIMP D-SUB MALE
DSC-4215	15 PIN HIGH-DENSITY CRIMP D-SUB FEMALE
DSC-4126	26 PIN HIGH-DENSITY CRIMP D-SUB MALE
DSC-4226	26 PIN HIGH-DENSITY CRIMP D-SUB FEMALE

D-SUB HOODS AND HARDWARE

The D-subminiature line of hoods and hardware complement the connectors. They include plastic, metalized plastic, metal, Ethernet styles and include all hardware. Also, a full complement of crimp contacts and assembly hardware are offered.

HOODS

ITEM #	DESCRIPTION
DSH-5109	9 PIN PLASTIC HOOD - GRAY
DSH-5115	15 PIN PLASTIC HOOD - GRAY
DSH-5125	25 PIN PLASTIC HOOD - GRAY
DSH-5137	37 PIN PLASTIC HOOD - GRAY
DSH-5150	50 PIN PLASTIC HOOD - GRAY
DSH-5309	9 PIN METALIZED PLASTIC HOOD
DSH-5315	15 PIN METALIZED PLASTIC HOOD
DSH-5325	25 PIN METALIZED PLASTIC HOOD
DSH-5409	9 PIN METAL HOOD
DSH-5415	15 PIN METAL HOOD
DSH-5425	25 PIN METAL HOOD
DSH-5615	15 PIN ETHERNET HOOD

CONTACTS

ITEM #	DESCRIPTION
DHA-2101	MALE CRIMP CONTACTS (100/PK)
DHA-2102	FEMALE CRIMP CONTACTS (100/PK)
DHA-2201	MALE HIGH-DENSITY CRIMP CONTACTS (100/PK)
DHA-2202	FEMALE HIGH-DENSITY CRIMP CONTACTS (100/PK)
DHA-3000	INSERTION/EXTRACTION TOOL

HARDWARE

ITEM #	DESCRIPTION
DHA-5010	THUMBSCREWS (SET OF 2)
DHA-5020	HEX STANDOFFS (SET OF 2)
DHA-5030	FEMALE SCREWLOCKS (SET OF 2)
DHA-5040	MALE SCREW RETAINERS (SET OF 2)
DHA-5080	LOCKING POST KIT
DHA-5090	SLIDE LATCH KIT



PLASTIC



METALIZED PLASTIC

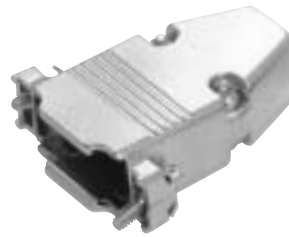

METAL



ETHERNET



HIGH-DENSITY CONTACTS



STANDARD CONTACTS



INSERTION/EXTRACTION TOOL



HEX STANDOFF



THUMB SCREW SET



MALE SCREW RETAINERS

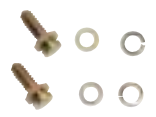

LOCKING POST KIT



FEMALE SCREW LOCK



SLIDE LATCH KIT



3 PIECE MALE CRIMP

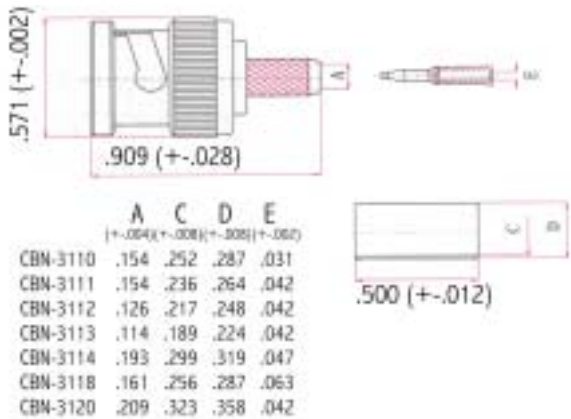

QUEST features a comprehensive selection of BNC connectors for a variety of cable sizes. The ones shown on this page are the 3-piece crimp design, which offers maximum results for both electrical and mechanical characteristics (best electrical contact and pull strength). These feature 50-OHM impedance specification, which is suitable for most applications except where 75 OHM impedance matching is critical.

3-PIECE MALE CRIMP

ITEM #	DESCRIPTION
CBN-3110	3 PC. BNC MALE FOR RG59/62 PVC
CBN-3111	3 PC. BNC MALE FOR RG59/62 PLENUM
CBN-3105	3 PC. BNC MALE FOR RG59 CATV WITH 22AWG CENTER
CBN-3112	3 PC. BNC MALE FOR RG58 PVC
CBN-3113	3 PC. BNC MALE FOR RG58 PLENUM
CBN-3114	3 PC. BNC MALE FOR RG6 PVC
CBN-3116	3 PC. BNC MALE FOR RG174/179
CBN-3118	3 PC. BNC MALE FOR RG11 PVC
CBN-3120	3 PC. BNC MALE FOR BELDEN 8281
CBN-3121	3 PC. BNC MALE FOR RG58 THINNET PLENUM

3-PIECE FEMALE CRIMP

ITEM #	DESCRIPTION
CBN-3210	3 PC. BNC FEMALE FOR RG59 PVC
CBN-3212	3 PC. BNC FEMALE FOR RG58 PVC
CBN-3214	3 PC. BNC FEMALE FOR RG6 PVC

SEE PAGE 59 FOR CONNECTOR TO TOOL SELECTOR



3 PIECE FEMALE CRIMP

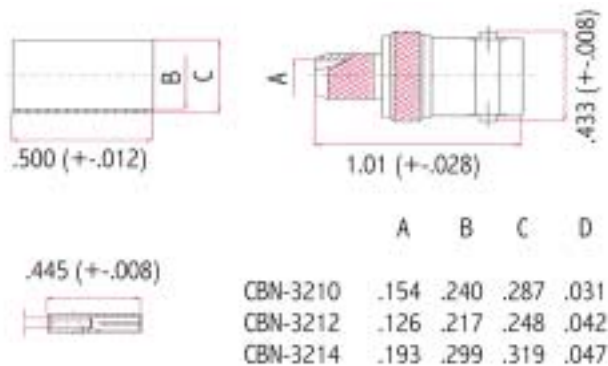

50 OHM BNC TWIST-ON & 2-PIECE CONNECTORS

The 2-piece crimp and solderless twist-on designs offer the installer an easier choice for terminating onto coaxial cables. The 2-piece design features a captivated center contact design so that crimping of the center contact is eliminated. Only the outer shield and jacket are crimped. The twist-on design can be terminated without the need of crimping tools and can be re-used simply by un-twisting the connector and re-twisting on the next termination. These are 50-OHM designs.

TWIST-ON

ITEM #	DESCRIPTION
CBN-1110	TWIST-ON BNC MALE FOR RG59/62 PVC
CBN-1111	TWIST-ON BNC MALE FOR RG59/62 PLENUM
CBN-1112	TWIST-ON BNC MALE FOR RG58 PVC
CBN-1115	TWIST-ON BNC MALE FOR RG58 THINNET
CBN-1116	TWIST-ON BNC MALE FOR RG58 PLENUM
CBN-1114	TWIST-ON BNC MALE FOR RG6 PVC
CBN-1117	TWIST-ON BNC MALE FOR BELDEN 8281

2-PIECE CRIMP

ITEM #	DESCRIPTION
CBN-2110	2 PC. BNC MALE CRIMP FOR RG59/62 PVC
CBN-2111	2 PC. BNC MALE CRIMP FOR RG59/62 PLENUM
CBN-2112	2 PC. BNC MALE CRIMP FOR RG58 PVC
CBN-2114	2 PC. BNC MALE CRIMP FOR RG6 PVC
CBN-2115	2 PC. BNC MALE CRIMP FOR RG6 PLENUM
CBN-2120	2 PC. BNC MALE CRIMP FOR BELDEN 8281
CBN-2122	2 PC. BNC MALE CRIMP FOR RG174



BNC MALE TWIST-ON

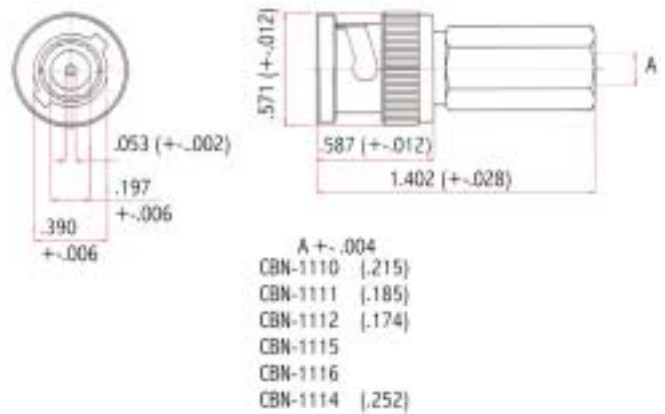

BNC 2 PIECE CRIMP

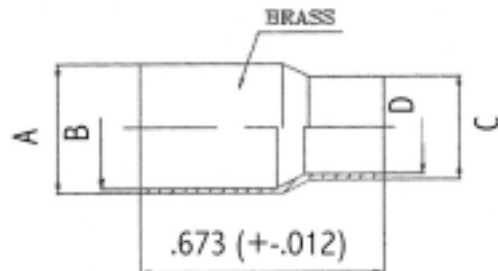
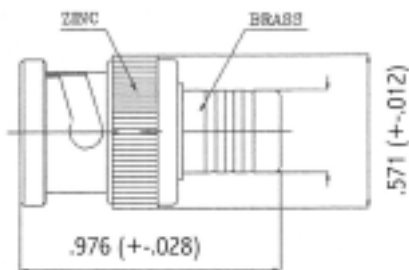

Please contact distributor for connector dimensions

75 OHM BNC CONNECTORS & ADAPTERS



3 PIECE MALE CRIMP



2 PIECE MALE CRIMP



TWIST-ON MALE



**BNC FEMALE
TO F MALE**



BNC IN-LINE SPLICE



**BNC ISOLATED
BULKHEAD**



**RIGHT ANGLE
FEMALE TO MALE**

BNC 75 OHM connectors are used where impedance matching becomes a critical application component. QUEST offers a line of 3-piece crimp, 2-piece crimp and twist-on designs to meet these interconnect demands. In addition, we offer a series of adapters designed specifically for 75-OHMS applications. These requirements are for applications in digital broadcast, satellite communications, telecommunications and test & measurement. QUEST provides these connectors to fit most popular cable sizes and are designed for optimum performance from DC to 1 Ghz bandwidth.

CONNECTORS

ITEM #	DESCRIPTION
CBB-3210	3-PC. CRIMP MALE-75 OHMS FOR RG59/62 PVC
CBB-3211	3-PC. MALE CRIMP-75 OHMS FOR RG59 PLENUM
CBB-3214	3-PC. MALE CRIMP-75 OHMS FOR RG6 PVC
CBB-3219	3-PC. MALE CRIMP-75 OHMS FOR BELDEN 8218
CBB-3220	3-PC. MALE CRIMP-75 OHMS FOR BELDEN 8281
CBB-2210	2-PC. MALE CRIMP-75 OHMS FOR RG59/62 PVC
CBB-2211	2-PC. MALE CRIMP-75 OHMS FOR RG59 PLENUM
CBB-2214	2-PC. MALE CRIMP-75 OHMS FOR RG6 PVC
CBB-2219	2-PC. MALE CRIMP-75 OHMS FOR BELDEN 8218
CBB-2220	2-PC. MALE CRIMP-75 OHMS FOR BELDEN 8281
CBB-1210	TWIST-ON MALE-75 OHMS-FOR RG59 PVC
CBB-1211	TWIST-ON MALE-75 OHMS-FOR RG59 TFE
CBB-1214	TWIST-ON MALE-75 OHMS-FOR RG6 PVC
CBB-1219	TWIST-ON MALE-75 OHMS-FOR BELDEN 8218
CBB-1220	TWIST-ON MALE-75 OHMS-FOR BELDEN 8281

ADAPTERS

ITEM #	DESCRIPTION
CAB-2000	IN-LINE SPLICE FEMALE - FEMALE
CBB-4233	ISOLATED BULKHEAD FEMALE - FEMALE
CAB-2015	RIGHT ANGLE FEMALE TO MALE
CAB-2005	BNC FEMALE TO F MALE

BNC CONNECTOR

BNC SPECIALITY CONNECTORS & FACEPLATES

There are many installation instances where specific types of connectors may be required. QUEST offers a family of BNC connector products which fills many of these requirements. Included in this offering are innovative designs such as the BNC male quick connector which requires no crimping or soldering. Also offered are BNC male and female solderless connectors with strain relief boots. These models also require no soldering and universally fit almost any size cable. A line of panel mount, bulkhead and PC BNC connectors are also offered along with stainless steel faceplates, which facilitate wall-mounting applications.

CONNECTORS

ITEM #	DESCRIPTION
CBQ-7010	BNC MALE QUICK CONNECTOR FOR RG59
CBQ-7011	BNC MALE QUICK CONNECTOR FOR RG58
CBQ-8000	BNC MALE SOLDERLESS UNIVERSAL CABLE FIT
CBQ-8001	BNC FEMALE SOLDERLESS UNIVERSAL CABLE FIT
CBN-4030	CHASSIS MOUNT BNC FEMALE SOLDER TYPE - WITH LUG
CBN-4031	ISOLATED CHASSIS MOUNT BNC FEMALE SOLDER TYPE
CBN-4032	BNC BULKHEAD MOUNT DOUBLE FEMALE - 1/2" MOUNTING DIAMETER
CBN-4033	ISOLATED BNC BULKHEAD MOUNT DOUBLE FEMALE - 1/2"
CBN-4034	BNC PC VERTICAL MOUNTING DIAMETER FEMALE
CBN-5150	BNC 50 OHM MALE TERMINATOR
CBN-5175	BNC 75 OHM MALE TERMINATOR

FACEPLATES

ITEM #	DESCRIPTION
CWP-1010	SINGLE 1/2" STAINLESS STEEL FACEPLATE
CWP-1030	DUAL 1/2" STAINLESS STEEL FACEPLATE



MALE TERMINATOR



BULKHEAD MOUNT FEMALE - FEMALE



BNC Quick Connector



BNC MALE SOLDERLESS



BNC FEMALE SOLDERLESS



CHASSIS MOUNT FEMALE



ISOLATED CHASSIS MOUNT FEMALE



PC VERTICAL MOUNT FEMALE



ISOLATED BULKHEAD FEMALE - FEMALE



SINGLE STAINLESS STEEL FACEPLATE



DUAL STAINLESS STEEL FACEPLATE

BNC SPECIALITY CONNECTORS

N CONNECTORS



**N MALE
SOLDER-CLAMP**

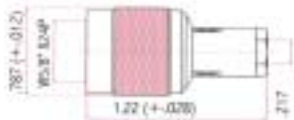

**N FEMALE
SOLDER-CLAMP**

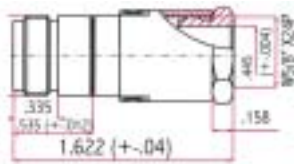

N MALE CRIMP



N FEMALE CRIMP

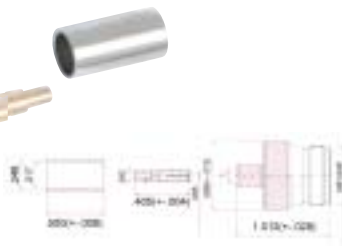

N CHASSIS MOUNT

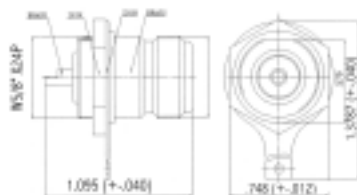

N series connectors feature excellent performance characteristics at high frequencies up to 11 GHz and are designed for 50-OHM impedance. These connectors are used in a variety of applications including microwave antennas, transmitters, broadcast, test & measurement, instrumentation and LAN's. QUEST offers these in solder-clamp and crimp configurations for several popular cable sizes.

N CONNECTORS

ITEM #	DESCRIPTION
CNC-6122	N SOLDER-CLAMP MALE FOR RG8, 11, 213, 214.
CNC-6123	N SOLDER-CLAMP MALE FOR RG58 PVC
CNC-6223	N SOLDER-CLAMP FEMALE FOR RG8/213
CNC-3112	N 3 PIECE CRIMP MALE FOR RG58 PVC
CNC-3022	N 3 PIECE CRIMP MALE FOR RG8, 11, 213
CNC-6224	N CHASSIS MOUNT SOLDER FEMALE

SPECIFICATIONS:

- Voltage Rating: 500 V AC
- Frequency Range: 0-11 GHz
- Insulation Resistance: 1,000 M
- Impedance: 50 OHM
- VSWR: 1.3 Max - 0-4 GHz

UHF connectors are widely used in communications equipment and are designed for low frequency applications up to 300 MHz. They are found in CB communications radios, amateur (ham) radio equipment, test & measurement, CCTV and mobile radio equipment. QUEST offers solder and crimp style male connectors as well as panel mount female versions. The male solder version features a high-temp bakelite insulator, which offers excellent heat resistance to high temperature soldering.

UHF CONNECTORS

ITEM #	DESCRIPTION
CUF-6122	UHF SOLDER MALE FOR RG8, 213, 214
CUF-9110	UG-175 REDUCER ADAPTER FOR RG59
CUF-9112	UG-176 REDUCER ADAPTER FOR RG58
CUF-6220	UHF CRIMP 3 PC. MALE FOR RG58
CUF-6230	UHF FLANGE PANEL MOUNT FEMALE
CUF-6240	UHF CIRCULAR PANEL MOUNT FEMALE

SPECIFICATIONS:

- Voltage Rating: 500 V AC
- Frequency Range: 0-300 MHz
- Insulation Resistance: 1,000 OHMS
- Impedance: Non-constant

QUEST OFFERS PROFESSIONAL INSTALLATION TOOLS FOR RF COAXIAL CONNECTORS.

PLEASE SEE PAGES 52 & 53 FOR CABLE CUTTING AND STRIPPING TOOLS AND PAGES 50 & 51 FOR CRIMPING TOOLS.

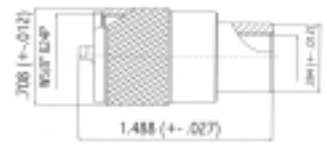

UHF MALE SOLDER

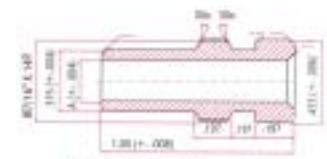

REDUCER ADAPTER

CUF-9110 A=.256
CUF-9112 A=.217

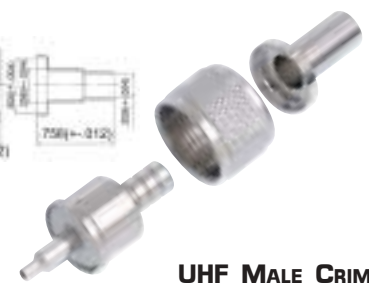
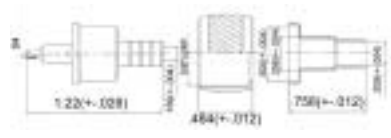

UHF MALE CRIMP

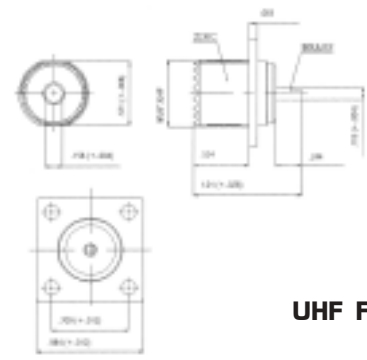

UHF FEMALE FLANGE MOUNT

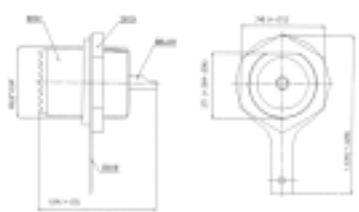

UHF FEMALE CIRCULAR MOUNT

RF COAXIAL CONNECTOR



MINI-UHF MALE CRIMP



MINI-UHF FEMALE CRIMP

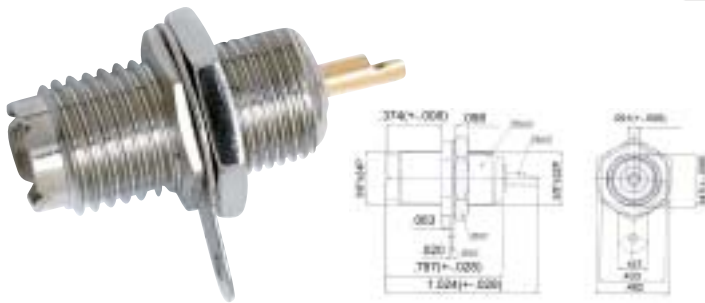

MINI-UHF FEMALE CHASSIS MOUNT

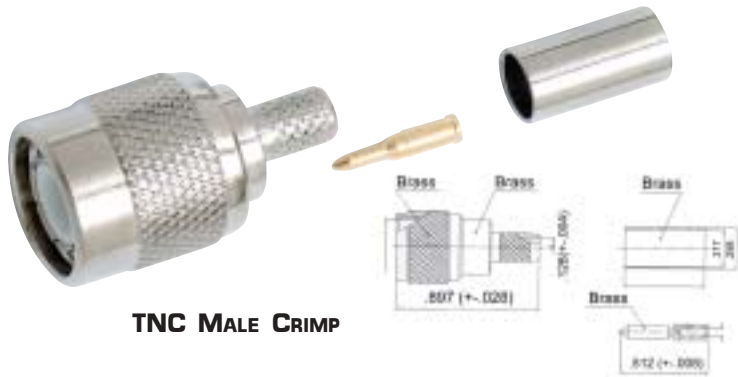

TNC MALE CRIMP



TWIN-AXIAL MALE CLAMP

The Mini-UHF, TNC and Twin-ax series line of connectors are designed for use in telecommunications, cellular communications and network applications. The Mini-UHF series are used primarily in cellular communications equipment where miniaturization, weight and cost are considerations. The TNC series, also used in cellular mobile phones, have extended applications in instrumentation, test & measurement, microwave components and others. Twin-ax connectors are used with twin-conductor 78 & 95-OHM cables in computer networking applications. The twin-ax connectors are designed with indexed slots to correctly polarize with its mating connector.

CONNECTORS

ITEM #	DESCRIPTION
CMU-3112	MINI-UHF 3PC. MALE CRIMP FOR RG58 PVC
CMU-3212	MINI-UHF 3PC. FEMALE CRIMP FOR RG58 PVC
CMU-3312	MINI-UHF PANEL MOUNT FEMALE SOLDER WITH NUT & WASHER
CTN-2112	TNC 3PC. MALE CRIMP FOR RG58 PVC
CTW-1000	TWIN-AX MALE CLAMP CONNECTOR

MINI-UHF/TNC/TW-AX CONNECTORS

F series connectors are specially designed for use in CATV, TV antenna / satellite dish connections as well as where almost all consumer video equipment is used. QUEST offers several design options for most popular cable sizes. The F crimp-on series are high-quality connectors manufactured with brass-machined heads and are highly reliable with excellent pull-strength characteristics. Also available are the compression style, twist-on and a new solderless style, allowing installers many application options.

FOR RG-59 CABLE

ITEM #	DESCRIPTION
CFC-7111	F MALE CRIMP WITH 0.5" RING FOR RG59 PVC
CFC-7112	F MALE CRIMP WITH 0.5" RING FOR RG59 PLENUM
CFC-7123	F MALE CRIMP WITH 0.5" RING FOR RG59 TRI-SHIELD
CFC-8110	F MALE COMPRESSION FOR RG59 SINGLE THRU TRI-SHIELD
CFC-1111	F MALE TWIST-ON FOR RG59

FOR RG-6 CABLE

ITEM #	DESCRIPTION
CFC-7114	F MALE CRIMP WITH 0.5" RING FOR RG6 PVC
CFC-7115	F MALE CRIMP WITH 0.5" RING FOR RG6 PLENUM
CFC-7124	F MALE CRIMP WITH 0.5" RING FOR RG6 TRI-SHIELD
CFC-7125	F MALE CRIMP WITH 0.5" RING FOR RG6 QUAD-SHIELD
CFC-7214	F MALE CRIMP WITH 0.5" RING FOR RG6 PVC WITH O-RING
CFC-7314	F MALE CRIMP WITH 0.5" RING FOR RG6 WITH GEL & O-RING
CFC-8114	F MALE COMPRESSION FOR RG6 SINGLE THRU QUAD-SHIELD
CFC-1114	F MALE TWIST-ON FOR RG6

RG-11 & SOLDERLESS

ITEM #	DESCRIPTION
CFC-7118	F MALE CRIMP FOR RG11 PVC
CFC-7119	F MALE CRIMP FOR RG11 PVC 1 PC. WITH CAPTIVE PIN
CFQ-9010	F MALE SOLDERLESS - RG59/6
CRQ-6000	RCA MALE SOLDERLESS



F MALE CRIMP



F MALE COMPRESSION



RG-11 F MALE CRIMP



F MALE TWIST-ON



F MALE SOLDERLESS

F SPLICES AND TERMINATOR



F-81 IN-LINE COUPLER

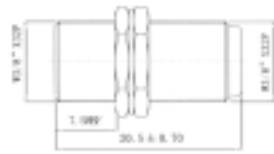

F-81 WITH NUT & WASHER



F-81 1GHz PERFORMANCE

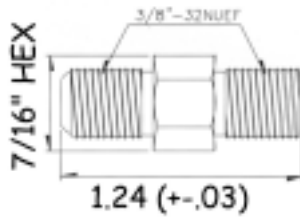

CATV F-81, BRASS MACHINED - 1 GHz PERFORMANCE WITH 1/2W 1% AUTO-LOAD RESISTOR 25-30db RETURN LOSS



F NUT & WASHER

QUEST offers a series of splices that mate with F series connectors for various mounting applications. These include female-to-female couplers for cable mounting and also versions with nut and washer for panel mounting requirements. QUEST also offers a coupler version designed for 1GHz applications, featuring an auto-termination resistor load design for system balancing when disconnected. Also offered is an F terminator for "dummy load" use.

F SPLICES & COUPLERS

ITEM #	DESCRIPTION
CFS-0181	F-81 IN-LINE COUPLER - FEMALE-TO-FEMALE
CFS-0182	F-81 IN-LINE COUPLER - FEMALE-TO-FEMALE WITH NUT & WASHER
CFS-0186	F-81 1GHz IN-LINE COUPLER WITH AUTO -TERMINATION
CFS-0183	F NUT & WASHER SET

TERMINATOR

ITEM #	DESCRIPTION
CFC-5175	F MALE TERMINATOR - 75 OHM

PLEASE SEE OUR SELECTION OF F TO F AND AUDIO/VIDEO CABLE ASSEMBLIES ON PAGES 66 & 67



F TERMINATOR



For design and manufacturing applications, QUEST offers a selection of panel mounted and board level F connectors. The panel-mounted designs are available for top-threaded or rear mounted bulkhead applications, with solderable center pins. The PC board designs are available for vertical or right angle applications.

QUEST also offers attenuator pads designed to decrease signal levels for testing and calibrating MATV systems. These are offered in female to male configurations in a variety of attenuator values.

PANEL & PC MOUNT

ITEM #	DESCRIPTION
CFS-0185	F-61 F FEMALE CHASSIS MOUNT WITH NUT & WASHER
CFS-0187	F-61 F FEMALE TOP HEX CHASSIS MOUNT WITH NUT & WASHER
CFS-0188	F-61 F FEMALE PC VERTICAL MOUNT
CFS-0189	F-61 F FEMALE RIGHT ANGLE PC MOUNT

ATTENUATORS

ITEM #	DESCRIPTION
CFS-0203	3DB F ATTENUATOR - FEMALE TO MALE
CFS-0206	6DB F ATTENUATOR - FEMALE TO MALE
CFS-0210	10DB F ATTENUATOR - FEMALE TO MALE
CFS-0220	20DB F ATTENUATOR - FEMALE TO MALE

Item #	Insertion Loss (± 1.0Db) 5-860MHz	Return Loss (dB) 5-860MHz
CFS-0203	3	20
CFS-0206	6	20
CFS-0210	10	20
CFS-0220	20	20

**OEM AND SPECIAL DESIGNS
ARE WELCOME**

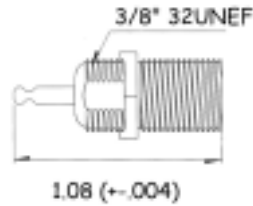

F-61 CHASSIS MOUNT

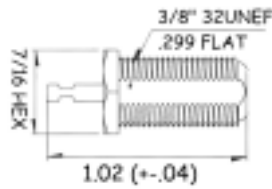

F-61 TOP HEX THREAD

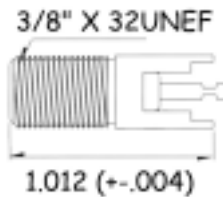

**F-61 VERTICAL
CHASSIS MOUNT**

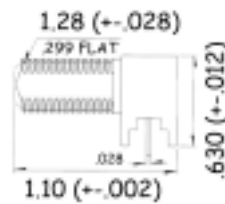

**F-61 RIGHT ANGLE
PC MOUNT**



F ATTENUATOR

R T O O P X I P U C O N N E C T O R

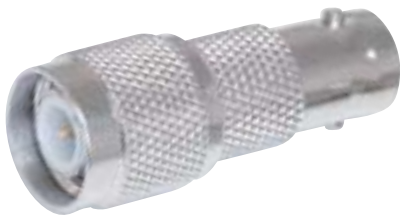

ITEM # CAD-1001 DESCRIPTION BNC FEMALE TO TNC MALE



ITEM # CAD-1015 DESCRIPTION BNC RIGHT ANGLE FEMALE-MALE



ITEM # CAD-1000 DESCRIPTION BNC IN-LINE SPLICE FEMALE-FEMALE



ITEM # CAD-1020 DESCRIPTION BNC TEE FEMALE-MALE-FEMALE



ITEM # CAD-1005 DESCRIPTION BNC FEMALE TO F MALE



ITEM # CAD-1025 DESCRIPTION BNC TEE FEMALE-FEMALE-FEMALE



ITEM # CAD-1010 DESCRIPTION BNC FEMALE TO RCA MALE



ITEM # CAD-1030 DESCRIPTION RCA FEMALE TO BNC MALE



Item # CAD-1035 DESCRIPTION F FEMALE TO BNC MALE



Item # CAD-1062 DESCRIPTION N MALE TO N MALE



Item # CAD-1002 DESCRIPTION TNC FEMALE TO BNC MALE



Item # CAD-1063 DESCRIPTION N FEMALE TO N FEMALE



Item # CAD-1055 DESCRIPTION N MALE TO BNC FEMALE



Item # CAD-1064 DESCRIPTION BNC FEMALE TO UHF MALE



Item # CAD-1061 DESCRIPTION N FEMALE TO BNC MALE



Item # CAD-1065 DESCRIPTION UHF FEMALE-FEMALE SPLICE

RF COAXIAL CONNECTOR

RF ADAPTERS



ITEM #

DESCRIPTION

CAD-1070 UHF SPLICE - LONG VERSION



ITEM #

DESCRIPTION

CAD-1085 MINI-UHF RIGHT ANGLE FEMALE-MALE



ITEM #

DESCRIPTION

CAD-1075 UHF FEMALE TO MINI UHF MALE



ITEM #

DESCRIPTION

CAD-1090 F FEMALE TO PUSH-ON F MALE



ITEM #

DESCRIPTION

CAD-1076 UHF FEMALE TO BNC MALE



ITEM #

DESCRIPTION

CAD-1095 F 90° FEMALE TO PUSH ON MALE



ITEM #

DESCRIPTION

CAD-1080 MINI-UHF FEMALE-FEMALE



ITEM #

DESCRIPTION

CAD-1100 F 90° FEMALE TO MALE

RF CONNECTOR MIXER



ITEM # DESCRIPTION
CAD-1105 F FEMALE TO 3.5mm MALE



ITEM # DESCRIPTION
CAD-1116 RCA FEMALE TO F FEMALE



ITEM # DESCRIPTION
CAD-1106 RCA FEMALE TO 3.5mm MALE



ITEM # DESCRIPTION
CAD-1120 F FEMALE TO PAL MALE



ITEM # DESCRIPTION
CAD-1110 RCA FEMALE TO F MALE



ITEM # DESCRIPTION
CAD-1125 F FEMALE TO PAL FEMALE



ITEM # DESCRIPTION
CAD-1115 RCA MALE TO F FEMALE



ITEM # DESCRIPTION
CAD-1130 F MALE TO PAL FEMALE



ITEM # DESCRIPTION
CAD-1117 RCA BULKHEAD FEMALE-FEMALE



ITEM # DESCRIPTION
CAD-1077 TNC FEMALE TO FEMALE

F & LARGE O.D. CRIMP TOOLS



F STANDARD CRIMPER



F & LARGE O.D. PRO CRIMPER



F COMPRESSION CRIMPER

F STANDARD CRIMPER

ITEM #	DESCRIPTION
TFC-4000	F STANDARD CRIMPER FOR RG59/62, 6 WITH HEX CRIMP. FEATURES PARALLEL ACTION AND NICKEL PLATED SURFACES

F & LARGE O.D. PRO CRIMPERS

ITEM #	DESCRIPTION
TFC-4010	F PRO CRIMPER FOR RG59/62/6 WITH TENSION ADJUSTMENT - HEX SIZES .255", .322"
TFC-4020	LARGE O.D. PRO CRIMPER FOR RG8/11/213 WITH TENSION ADJUSTMENT - HEX SIZES .100", .322", .448"
TFC-4030	LARGE O.D. PRO CRIMPER FOR RG6/8/11 WITH TENSION ADJUSTMENT - HEX SIZES .100", .359", .406"

F COMPRESSION CRIMPER

ITEM #	DESCRIPTION
TFC-4040	F COMPRESSION TOOL FOR ATTACHING WEATHERPROOF COMPRESSION RG 59/RG6 F CONNECTORS. ALSO WORKS FOR MOST COMPETITIVE BRANDS OF COMPRESSION CONNECTORS

PLEASE SEE PAGE 43 FOR OUR FULL LINEUP OF F CONNECTORS - ALSO SEE PAGE 52 FOR COAX STRIPPERS



**Lifetime
Warranty**



PLEASE SEE PAGE 59 FOR CONNECTOR TO TOOL REFERENCE CHART

The QUEST Professional Ratchet Crimp Tool series provides installers the best choice in professional connector crimp tools. These tools are designed for durable use and provides long life dependability and consistent, reliable terminations, crimp after crimp. They feature a 10" frame design, which allows increased leverage during the crimp process with a ratchet action mechanism providing easy, repeatable and reliable crimps. The tools come complete with die sets, which are also interchangeable. **Lifetime warranted.**

RATCHET CRIMP TOOLS

ITEM #	DESCRIPTION	HEX SIZES
TRF-3000	USE FOR RG-58, 59/62 BNC/TNC 3PC. CONNECTORS	.255", .213", .068"
TRF-3001	USE FOR RG-58, RG-59/62AU BNC/TNC 2PC CONNECTORS	.305", .228", .068"
TRF-3030	USE FOR RG-8 N CONNECTORS	.429", .128", .100"
TRF-3020	USE FOR RG-59, RG-6 TYPE CONNECTORS	.350", .320", .255"
TRF-3035	USE FOR RG-58, RG-174, BELDEN 8218 3PC. CONNECTORS	.213", .178", .068", .042"
TRF-3040	USE FOR RG-59, RG-6 & BELDEN 8281 3PC CONNECTORS	.324", .255", .068", .042"
TRF-3045	USE FOR RG-6, RG-174 & BELDEN 8281 3PC. CONNECTORS	.324", .178", .068"
TRF-3015	USE FOR RG-58, RG-59/62 BNC/TNC, MINI-UHF CONNECTORS	.255", .213", .100", .068", .052"
TRF-3010	USE FOR RG-58, RG-59 PLENUM 3PC. CONNECTORS	.213", .190", .068", .042"
TRF-3050	USE FOR 10-22 AWG NON-INSULATED TERMINALS	GAUGE SIZE MARKINGS
TRF-3051	USE FOR 10-22 AWG INSULATED TERMINALS	COLOR CODED NESTS
TRF-3052	USE FOR 12-22 AWG NON-INSULATED OPEN BARREL CONTACTS & TERMINALS	GAUGE SIZE MARKINGS
TRF-3054	USE FOR FIBER CRIMP CONNECTORS	.213", .178", .151"
TRF-3056	USE FOR RG6 BNC, RG59 PLENUM F	.275", .213", .068"

INSTALLATION TOOLS



COAXIAL WIRE STRIPPERS

**Lifetime
Warranty**



SELF-ADJUSTING STRIPPERS



ADJUSTABLE STRIPPER TCS-5040



ADJUSTABLE STRIPPER TCS-5030



ADJUSTABLE STRIPPER TCS-5020



4-WAY COAX/UTP/WIRE STRIPPER

QUEST offers a comprehensive selection of coaxial cable stripping tools that allow the installer proper cable prepping prior to connectorization. These range from adjustable to self-adjusting designs for a wide range of cable sizes.

SELF-ADJUSTING STRIPPERS

ITEM #	DESCRIPTION
TCS-5000	2-CUT SELF-ADJUSTING COAX STRIPPER FOR RG-58, RG-59/62, RG-6 CABLES
TCS-5010	3-CUT SELF-ADJUSTING COAX STRIPPER FOR RG-58, RG-59/62, RG-6 CABLES

ADJUSTABLE STRIPPERS

ITEM #	DESCRIPTION
TCS-5020	2-BLADE STANDARD ADJUSTABLE COAX STRIPPER FOR RG-58, RG-59/62, RG-6, RG-6 QUAD SHIELD
TCS-5030	3-BLADE STANDARD ADJUSTABLE COAX STRIPPER FOR RG-58, RG-59/62, RG-6 CABLES
TCS-5040	3-BLADE STANDARD ADJUSTABLE COAX STRIPPER FOR LARGE O.D. RG-8, RG-11, RG-213 CABLES
TCS-5120	3-BLADE CARTRIDGE DELUXE ADJUSTABLE COAX STRIPPER FOR RG-58, RG-59, RG-6 WITH 3-BLADE CARTRIDGE
TEL-6100	4-WAY COAX/UTP/WIRE STRIPPER AND CUTTER

REPLACEMENT BLADES

ITEM #	DESCRIPTION
TSB-5021	RED 3-BLADE CARTRIDGE FOR TCS-5120 - STRIPS BRAID .328"
TSB-5022	GREEN 2-BLADE CARTRIDGE FOR TCS-5120 - STRIPS BRAID .480"
TSB-5023	BLUE 2-BLADE CARTRIDGE FOR TCS-5120 - STRIPS BRAID .250"



DELUXE ADJUSTABLE STRIPPER

QUEST offers a line of cable cutting tools designed to cut cables ranging in sizes from small O.D. to 2 inches in diameter. The cutters are manufactured with precision ground hardened carbon steel cutting edges for clean and undistorted cuts. Also offered is a cable tie installation tool which speeds up cable installation time. This tool is designed to ensure correct tension and provides automatic cut-off of the cable ties.

WIRE-CABLE CUTTERS

ITEM #	DESCRIPTION
TMI-1030	ROUND CABLE & WIRE CUTTER FOR CUTTING MULTI-CONDUCTOR CABLE UP TO .5" AND STRANDED OR SOLID WIRE UP TO 8 AWG. FEATURES SOFT HANDLES, LOCKING LATCH AND BUILT-IN RETURN SPRING
TMI-1031	FOR CUTTING UP TO 100 PAIR GROUP TELEPHONE CABLE AND SMALL THROUGH LARGE O.D. COAXIAL CABLE - FEATURES SOFT HANDLES, LOCKING LATCH AND BUILT-IN RETURN SPRING
TMI-1040	RATCHET CABLE CUTTER FOR CUTTING LARGE O.D. (380mm ²) AND SMALLER HARD-DRAWN COPPER AND ALUMINUM CABLES. FEATURES HARDENED STEEL BLADES AND QUICK RELEASE MECHANISM

WIRE-TIE TOOL

ITEM #	DESCRIPTION
TMI-1015	CABLE-TIE INSTALLATION TOOL - TIE WIDTH FROM .1" TO .2" - AUTOMATIC TIE CUT-OFF-METAL FRAME CONSTRUCTION



ROUND CABLE & WIRE CUTTER



100 PAIR GROUP CUTTER



RATCHET CABLE CUTTER



CABLE TIE INSTALLATION TOOL

WIRE STRIPPERS



20-30 AWG WIRE STRIPPER



10-22 AWG WIRE STRIPPER

QUEST offers a series of wire stripping tools that provide accurate strips for wires ranging from 10 AWG to 30 AWG. These strippers are quality built and feature high-carbon steel finished with black oxide to prevent rust. Also TMI-1021 and TMI-1020 features a convenient table printed on the handle to convert AWG to millimeters.

WIRE STRIPPERS

ITEM #

DESCRIPTION

TMI-1021	20-30 AWG MULTI-GAUGE WIRE STRIPPER WITH BUILT-IN CUTTER AND WIRE GAUGE CONVERSION TABLE
TMI-1020	10-22 AWG MULTI-GAUGE WIRE STRIPPER WITH BUILT-IN CUTTER AND WIRE GAUGE CONVERSION TABLE
TMI-1025	WIRE STRIPPER & CUTTER FOR 10-24 AWG SOLID OR STRANDED WIRE - COMPACT 5" TOOL ADJUSTS QUICKLY TO ANY OF 8 WIRE SIZES

**Lifetime
Warranty**



WIRE STRIPPER & CUTTER

For punch-down cable terminations, QUEST offers a wide variety of tools to do the job right. Starting with the economical UTP stripper with self-contained 110 punchdown blade tip to the multi-pair impact punch-down tool capable of seating 5 pairs at a time, QUEST has the right tool for installers.

PUNCH DOWN TOOLS

ITEM #	DESCRIPTION
TEL-6110	ECONOMY UTP STRIPPER WITH 110 PUNCH-DOWN BLADE TIP
TEL-6070	NON-IMPACT PUNCH TOOL WITH 66/110 BLADE (PUNCH ONLY)
TEL-6080	IMPACT PUNCH-TOOL WITH 110 BLADE (PUNCH AND CUT) - IMPACT ADJUSTMENT AND BLADE STORAGE
TEL-6090	PRO GRADE PUNCH-TOOL WITH 110 TWIST-LOCK BLADE (PUNCH AND CUT) - ADJUSTABLE HIGH-LOW ACTUATION SETTING AND LOCKING STORAGE COMPARTMENT
TEL-6120	MULTI-PAIR IMPACT PUNCH-DOWN TOOL SEATS UP TO 5 PAIRS WITH ONE ACTION - SUITABLE FOR 110 CROSS - CONNECT TERMINAL BLOCKS - REVERSIBLE TERMINATION BLOCK FOR PUNCH AND CUT OR PUNCH ONLY

REPLACEMENT BLADES

ITEM #	DESCRIPTION
TEL-6085	110 PUNCH/PUNCH-CUT BLADE FOR TEL-6070, TEL-6080
TEL-6097	66 PUNCH/PUNCH-CUT TWIST-LOCK BLADE FOR TEL-6090
TEL-6098	110 PUNCH/PUNCH-CUT TWIST-LOCK BLADE FOR TEL-6090
TEL-6099	KRONE PUNCH/PUNCH-CUT TWIST-LOCK BLADE FOR TEL-6090



**ECONOMY UTP STRIPPER
w/110 BLADE**



**NON-IMPACT PUNCH TOOL
w/66-110 BLADE**



**IMPACT PUNCH-DOWN TOOL
w/110 BLADE**



**PRO GRADE IMPACT PUNCH-DOWN TOOL
w/110 BLADE**



MULTI-PAIR IMPACT PUNCH-DOWN TOOL



ECONOMY 4C & 6C MODULAR CRIMPER



ECONOMY 8C MODULAR CRIMPER



**INSTALLER GRADE 4C, 6C & 8C
 MODULAR CRIMPER**

QUEST offers a comprehensive selection of modular plug crimp tools that provide reliable electrical and mechanical connections. Included are models ranging from economical to high-end designs. Tools vary in size applications from 4-contact handset to 10 position/10 contact sizes.

ECONOMY LINE

ITEM #	DESCRIPTION
TEL-6040	CRIMPS 6P2C, 6P4C RJ-11, 6P6C RJ-12. FEATURES HARDENED STEEL FRAME WITH CUTTING AND STRIPPING BLADES
TEL-6050	CRIMPS 8P8C RJ-45. FEATURES HARDENED STEEL FRAME WITH CUTTING AND STRIPPING BLADES

INSTALLER GRADE WITH RATCHET

ITEM #	DESCRIPTION
TEL-6030	CRIMPS 6P4C RJ-11, 6P6C RJ-12, 8P8C RJ-45 WITH RATCHET MECHANISM INSTALLER GRADE STEEL FRAME IS LIGHT WEIGHT AND DURABLE



For heavy-duty termination use, QUEST provides a selection of high-quality modular crimp tools designed for high repeatability applications such as assembly operations or for the installation professional that demands guaranteed results. This series includes ratchet and non-ratchet mechanism designs and are offered for most modular connector sizes.

NON RATCHET MECHANISM

ITEM #	DESCRIPTION
TEL-6000	CRIMPS 6P4C RJ-11, 6P6C RJ-12, 8P8C RJ-45. FEATURES CABLE CUTTER AND STRIPPER, HEAT-TREATED CARBON STEEL FRAME AND SAFETY BLADE GUARD

WITH RATCHET MECHANISM

ITEM #	DESCRIPTION
TEL-6001	CRIMPS 6P4C RJ-11, 6P6C RJ-12, 8P8C RJ-45. FEATURES RATCHET MECHANISM, CABLE CUTTER AND STRIPPER, HEAT-TREATED CARBON STEEL FRAME AND SAFETY BLADE GUARD
TEL-6020	CRIMPS 4P2C/4P4C HANDSET, 6P4C RJ-11, 6P6C RJ-12, DEC OFFSET 6P6C, AMP 8P8C RJ-45 10P10C. FEATURES RATCHET MECHANISM WITH SAFETY RELEASE, STRAIGHT MOTION DIE MECHANISM FOR PRECISE CRIMPS AND BUILT-IN CUTTER AND STRIPPER



**Pro 4C, 6C & 8C
MODULAR CRIMPER**

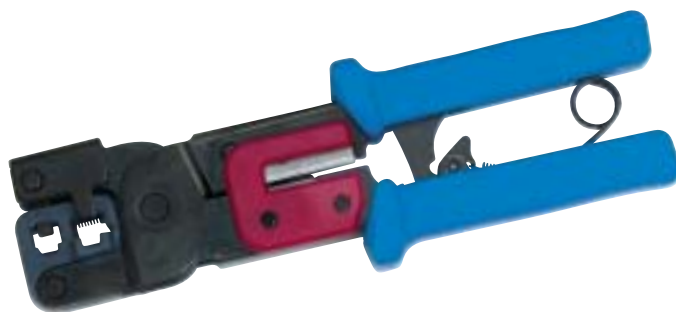

**Pro 4C, 6C & 8C
MODULAR RATCHET CRIMPER**



**Pro 2C, 4C, 6C, 6DEC, 8C 10C
MODULAR RATCHET CRIMPER**





LINEMAN'S TEST SET



TONE GENERATOR



AMPLIFIER PROBE

QUEST provides several quality products for installers of telephone, data and security cables. These include a rugged lineman's test set, an amplifier probe for tracing wiring and a tone generator for locating and identifying cable pairs or conductors individually. These are quality products designed for professional use.

LINEMAN'S TEST SET

ITEM #	DESCRIPTION
TTE-2000	LINEMAN'S TEST SET WITH TMF AND PULSE MODE SELECTIVITY. ALSO FEATURES LAST NUMBER REDIAL, HIGH/LOW IMPEDANCE MONITOR AND RINGING. RUGGED AND IMPACT RESISTANT CASE FEATURES A SPRING-LOADED BELT CLIP. INCLUDED IS A PVC INSULATED TINSEL WIRE TEST CORD WITH PIERCING ALLIGATOR CLIPS WITH BED OF NAILS.

AMPLIFIER PROBE - TONE GENERATOR

ITEM #	DESCRIPTION
TTE-2100	AMPLIFIER PROBE AND TONE GENERATOR SET INCLUDES BOTH UNITS IN ZIPPERED CARRY CASE. THE AMPLIFIER PROBE IS DESIGNED TO IDENTIFY AND TRACE WIRES. IT FEATURES A VOLUME CONTROL AND RECESSED ON/OFF SWITCH. THE TONE GENERATOR FEATURES SELECTABLE SINGLE OR DUAL ALTERNATING TONE, A 3-COLOR LED FOR LINE POLARITY, CONTINUITY AND VOLTAGE TESTING. INCLUDED ARE A TEST LEAD SET AND RJ-11 4 CONDUCTOR CORD AND PLUG.
TTE-2101	AMPLIFIER PROBE ONLY
TTE-2102	TONE GENERATOR ONLY

FIBER OPTIC TERMINATION KIT

QUEST provides a connectorization kit, which contains the tools and supplies necessary to terminate fiber connectors. All products are packaged in a hard case with instruction book.

ITEM #	DESCRIPTION
NFK-7000	FIBER OPTIC TERMINATION KIT

The kit contains the following:

- 1- ABS CASE • 1- 100x MICROSCOPE • 1- 5" SCISSORS
- 1- BUFFER STRIPPER • 1- JACKET STRIPPER
- 1- RATCHET CRIMP TOOL W/DIE
- 1- ROUND CABLE SLITTER • 1- DIAMOND SCRIBE
- 1- GLASS POLISH PAD • 10- 3 IN 1 POLISH FILM
- 1- SC POLISH DISC • 1- ST POLISH DISC
- 1- WIPE PAPER
- 1- UV ADHESIVE FOR FIBER CABLE
- 5- EPOXY 353ND • 1- TAPE ROLL - GRAY
- 1- ALCOHOL BOTTLE • 1- PLASTIC WORK PAD • 5- SYRINGES
- 2- COMPONENT STORAGE BOXES • 1- INSTRUCTION MANUAL



CONNECTOR TO TOOL REFERENCE CHART

QUEST ITEM #	DIE SIZE (S)	ECONOMY CRIMPER	DELUXE CRIMPER	QUEST ITEM #	DIE SIZE (S)	ECONOMY CRIMPER	DELUXE CRIMPER
CBB-2210	.305/.255			CBN-3120	.305/.068		TRF-3001
CBB-2211	.305/.228		TRF-3001 (DIE 3000)	CBN-3121	.190/.068		TRF-3010
CBB-2214	.305/.255		TRF-3001	CBN-3210	.255/.068		TRF-3000
CBB-2219	.190/.068		TRF-3001 (DIE 3000)	CBN-3212	.228/.068		TRF-3001
CBB-2220	.350/.320		TRF-3010	CBN-3214	.305/.068		TRF-3001
CBB-3210	.255/.068		TRF-3020	CFC-7111	.324	TFC-4020	TRF-3040
CBB-3211	.228/.068		TRF-3000	CFC-7112	.275		TRF-3056
CBB-3214	.275/.068		TRF-3001	CFC-7114	.324	TFC-4020	TRF-3040
CBB-3219	.190/.068		TRF-3056	CFC-7115	.324	TFC-4020	TRF-3040
CBB-3220	.305/.068		TRF-3010	CFC-7118	.470	TFC-4035	
CBN-2110	.305/.255		TRF-3001	CFC-7119	.448	TFC-4020	
CBN-2111	.305/.228		TRF-3001 (DIE 3000)	CFC-7123	.324	TFC-4020	TRF-3040
CBN-2112	.305/.228		TRF-3001	CFC-7124	.324	TFC-4020	TRF-3040
CBN-2114	.305/.275		TRF-3001	CFC-7214	.324	TFC-4020	TRF-3040
CBN-2115	.305/.255		TRF-3001 (DIE 3056)	CFC-7314	.324	TFC-4020	TRF-3040
CBN-2120	.350/.320		TRF-3001 (DIE 3000)	CFC-8110			TFC-4040
CBN-2122	.305/.128		TRF-3020	CFC-8114			TFC-4040
CBN-3105	.255/.068		TRF-3001 (DIE 3030)	CMU-3112	.228/.068		TRF-3000
CBN-3110	.255/.068		TRF-3000	CNC-3212	.228/.068		TRF-3000
CBN-3111	.228/.068		TRF-3000	CNC-3022	.406/.100	TFC-4030	
CBN-3112	.213/.068		TRF-3001	CNC-3112	.213/.068		TRF-3000
CBN-3113	.190/.068		TRF-3000	CPC-7125	.324	TFC-4020	TRF-3040
CBN-3114	.275/.068		TRF-3010	CTN-2112	.213/.042		TRF-3010
CBN-3116	.213/.100/.052		TRF-3056	CUF-6220	.190/.042		TRF-3010
CBN-3118	.410/.096	TFC-4035	TRF-3015				



MINI 2-WAY SPLITTER



2-WAY SPLITTER



3-WAY SPLITTER



4-WAY SPLITTER



6-WAY SPLITTER

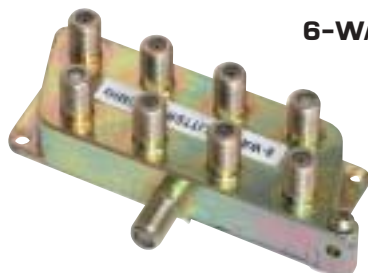

8-WAY SPLITTER

For TV signal management, QUEST provides a comprehensive selection of 5-900MHz signal splitters. This series feature high-strength zinc die-cast housings, anticorrosive finish and precision threads. Mounting screws are provided.

ITEM #	DESCRIPTION
VSP-1210	2-WAY 5-900MHz SPLITTER IN MINI HOUSING
VSP-1220	2-WAY 5-900MHz SPLITTER IN STANDARD HOUSING
VSP-1320	3-WAY 5-900 MHz SPLITTER IN STANDARD HOUSING
VSP-1420	4-WAY 5-900MHz SPLITTER IN STANDARD HOUSING
VSP-1620	6-WAY 5-900MHz SPLITTER IN LARGE HOUSING
VSP-1820	8-WAY 5-900MHz SPLITTER IN LARGE HOUSING

SPECIFICATIONS

Parameter	Frequency (MHz)	2-Way	3-Way	4-Way	6-Way	8-Way
Insertion Loss IN-OUT (dB Max)	5-300	2.8	3.2	6.7	9.1	10.1
	300-450	3.0	3.4	7.2	9.9	10.8
	450-600	3.3	3.5	7.5	10.3	11.3
	600-900	3.5	3.8	7.8	10.8	12.0
Return loss Input (dB Min.)	5-300	12	11	12	12	12
	300-450	14	12	15	13	13
	450-600	15	15	13	15	14
	600-900	12	12	11	12	12
Return loss Output (dB Min.)	5-300	12	12	15	11	12
	300-450	15	13	12	12	15
	450-600	13	15	11	12	15
	600-900	12	12	12	11	13
Isolation Output (dB Min.)	5-300	25	22	24	23	25
	300-450	28	25	25	25	26
	450-600	26	25	24	22	24
	600-900	25	23	23	22	24
Impedance RFI (dB)	500 mA	75ohm	75ohm	75ohm	75ohm	75ohm
	5-900	85dB	85dB	85dB	85dB	85dB

For high frequency applications such as broadband CATV, MATV, SMATV and MMDS systems, QUEST offers high quality splitters and directional couplers featuring 5 to 1000 MHz frequency range. These products also feature high quality tin plated zinc die-cast housings with PC board component design, solder back housing allowing -130dB RFI shielding. All ports are DC blocked.

SPLITTERS

ITEM #	DESCRIPTION
VSP-2220	2-WAY 1 GHz SPLITTER - SOLDER-BACK - 130dB RFI SHIELDING - DC POWER BLOCK
VSP-2320	3-WAY 1 GHz SPLITTER - SOLDER-BACK - 130dB RFI SHIELDING - DC POWER BLOCK
VSP-2420	4-WAY 1 GHz SPLITTER - SOLDER-BACK - 130dB RFI SHIELDING - DC POWER BLOCK

DIRECTIONAL COUPLERS

ITEM #	DESCRIPTION
VTP-1106	6dB 1 GHz 1-WAY TAP
VTP-1109	9dB 1 GHz 1-WAY TAP
VTP-1112	12dB 1 GHz 1-WAY TAP
VTP-1116	16dB 1 GHz 1-WAY TAP
VTP-1120	20dB 1 GHz 1-WAY TAP
VTP-1124	24dB 1 GHz 1-WAY TAP
VTP-1127	27dB 1 GHz 1-WAY TAP
VTP-1130	30dB 1 GHz 1-WAY TAP

SPECIFICATIONS SPLITTERS

Parameter	Frequency (MHz)	2-Way	3-Way	4-Way
Insertion Loss	5-4	3.2	5.3	6.7
	4-400	3.2	5.5	6.9
IN-OUT (dB Max)	400-600	3.3	5.8	7.5
	600-1000	3.5	6.5	7.8
Return loss Input (dB Min.)	5-4	24	22	22
	4-400	30	24	24
	400-600	28	25	25
	600-1000	24	24	23
Return loss Output (dB Min.)	5-4	22	21	24
	4-400	25	23	26
	400-600	28	25	25
	600-1000	24	22	23
Isolation Out-Out (dB Min.)	5-4	26	28	24
	4-400	32	32	28
	400-600	28	28	24
	600-1000	25	25	23
Impedance RFI (dB)	500 mA	75ohm	75ohm	75ohm
	5-900	85dB	85dB	85dB



2-WAY SPLITTER

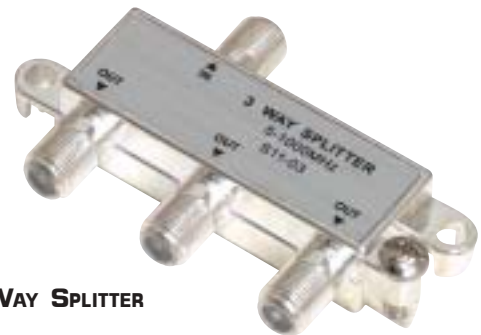

3-WAY SPLITTER



4-WAY SPLITTER



MINI DIRECTIONAL COUPLER

SIGNAL COMBINERS/SEPARATORS

QUEST offers products for combining and separating various video signal applications. These include products that eliminate the need for switches and products that merge satellite and off-air TV signals.



**VHF Low/Hi Band
SEPARATOR / COMBINER**



**UHF/VHF BAND
SEPARATOR / COMBINER**



**COMPACT
SEPARATOR / COMBINER**

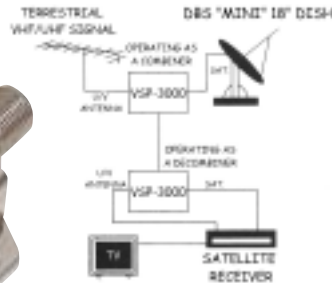

SIGNAL COMBINER

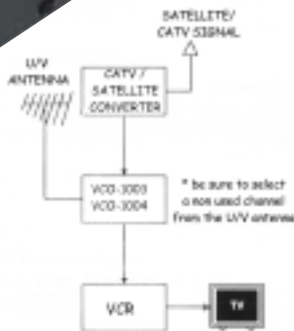

ITEM #

DESCRIPTION

- VTP-3010 HIGH-LOW FREQUENCY SEPARATOR / JOINER - SEPARATES LOW (CH.2-6/FM) AND HIGH (CH.7-13) BANDS FROM 1 INPUT OR JOINS TO A SINGLE OUTPUT
- VTP-3020 UHF/VHF BAND SEPARATOR / JOINER

**SPECIFICATIONS
SEPARATOR/COMBINER**

VTP-3010

- BANDWIDTH: 54-216 MHz
- LOW BAND REJECTION : 20dB (CH.2-6/FM)
- HIGH BAND REJECTION: 20dB (CH.7-13)
- INSERTION LOSS: 0.5dB
- IMPEDANCE: 75 OHMS
- POWER PASSIVE: LOW BAND ONLY

VTP-3020

- BANDWIDTH: 54-890MHz
- VHF BAND REJECTION: 23dB MIN.
- UHF BAND REJECTION: 30dB MIN.
- INSERTION LOSS VHF: 0.5dB
- INSERTION LOSS UHF: 0.8dB
- IMPEDANCE: 75 OHM
- POWER PASSIVE: VHF ONLY

SATELLITE DIPLEXER

ITEM #

DESCRIPTION

- VSP-3000 COMPACT SATELLITE DIPLEXER/COMBINER DIE CAST HOUSING

Frequency	Range	40-2150MHz
Insertion Loss	IN/OUT-TV	40-860MHz: 1.5±1.0dB
	IN/OUT-SAT	40-860MHz: 20 dB
	IN/OUT-TV	950-2150MHz: 15dB
	IN/OUT-SAT	950-2150MHz: 2±2dB
DC-Pass	IN/OUT-TV	NONE
	IN/OUT-SAT	500ma MAX

SIGNAL COMBINERS

ITEM #

DESCRIPTION

- VCO-1003 CHANNEL 3 SIGNAL COMBINER
- VCO-1004 CHANNEL 4 SIGNAL COMBINER

Video switching devices are necessary when selecting a single signal to two TV's or video devices or when two signal inputs need to be connected to a single TV or video device. QUEST offers 2 models of these commonly called A-B switches.

QUEST also offers RF modulators, which are used to convert composite video and audio signals such as cameras, satellite receivers, computer games and VCR's to modulated RF (Radio Frequency) signals, which are compatible with antenna connections on TV's

A-B SWITCHES

ITEM #	DESCRIPTION
VAB-1000	ECONOMY A-B SWITCH -MEDIUM ISOLATION HIGH RELIABILITY SWITCH
VAB-2000	DELUXE PUSH-BUTTON A-B SWITCH HIGH-SHIELDING - HIGH ISOLATION

R.F. MODULATORS

ITEM #	DESCRIPTION
VCO-1100	R.F. MODULATOR FOR CHANNEL 3-4 SELECTABLE OUTPUT
VCO-1110	UHF MODULATOR WITH ADJUSTABLE OUTPUT CHANNELS 14-32

**SPECIFICATIONS
MODULATORS**

VCO-1100

- FREQUENCY RANGE: VHF CH.3-4 SELECTABLE
- VIDEO INPUT: COMPOSITE NTSC NEGATIVE SYNC
- OUTPUT IMPEDANCE: 75 OHM
- OUTPUT LEVEL: 10dBmv
- FREQUENCY STABILITY: VIDEO: 250KHz (0.5%)
AUDIO: ± 3KHz

VCO-1110

- FREQUENCY RANGE: UHF CH. 14-32 ADJUSTABLE
- VIDEO INPUT: COMPOSITE NTSC NEGATIVE SYNC
- OUTPUT IMPEDANCE: 75 OHM
- OUTPUT LEVEL: 10dBmv



2-WAY A/B SWITCH



**HEAVY DUTY 2-WAY
A/B SWITCH**



VHF RF MODULAR



UHF RF MODULAR

CATV/MATV SATELLITE

VAM-2110



VAM-1412



VAM-2125



VAM-2130



QUEST offers a series of signal amplifiers designed to boost RF signal levels where low-level signals are present or where distribution for multiple TV's is required. Several models are available with various amplification, bandwidth and distribution designs for residential and small building applications.

AMPLIFIERS

ITEM #	DESCRIPTION
VAM-2110	10dB VHF/UHF 1 OUTPUT SIGNAL AMPLIFIER
VAM-1412	18dB VHF-UHF 4 OUTPUT SIGNAL AMPLIFIER /SPLITTER
VAM-2125	25dB VHF-UHF 1 OUTPUT WITH GAIN CONTROL
VAM-2130	6dB 1GHz 2-OUTPUT CABLE TV AMPLIFIER
VAM-4000	20dB 950-2150MHz IN-LINE AMP FOR SATELLITE REQUIRES POWER INSERTER

SPECIFICATIONS
AMPLIFIERS

MODEL	GAIN (dB)		NOISE FIGURE (dB)	MAX. INPUT (dBmV)	
	VHF	UHF		VHF	UHF
VAM-2110	10	7	7	32	20
VAM-1412	18	14	7	30	20
VAM-2125	25	21	6	40	20
VAM-2130	6	3	7	32	20

IN-LINE AMPLIFIER

MODEL	GAIN (dB) (950-2150 MHz)	NOISE	VSWR	POWER REQUIRED
VAM-4000	12 - 20 dB	6 dB	2.5:1	15-18 VDC



VAM-4000

In addition to our expanded line of CATV/MATV products, QUEST provides a series of impedance matching transformers, both for indoor and outdoor applications. Also offered are grounding blocks, nailable cable clips and feed-through cable bushings for RG-59 and RG-6 sizes.

MATCHING TRANSFORMERS

ITEM #	DESCRIPTION
VMT-1000	75-300 OHM INDOOR MATCHING TRANSFORMER
VMT-2000	75-300 OHM WEATHERPROOF MATCHING TRANSFORMER WITH #10 WIRE LEADS
VMT-3000	75-300 OHM WEATHERPROOF MATCHING TRANSFORMER WITH 300 OHM TWIN-LEAD

GROUNDING BLOCKS

ITEM #	DESCRIPTION
VGB-1001	SINGLE GROUNDING BLOCK WITH ZINC DIE-CAST F COUPLER
VGB-1002	DUAL GROUNDING BLOCK WITH 2 ZINC DIE-CAST F COUPLERS

CABLE CLIPS

ITEM #	DESCRIPTION
VCC-1101	WHITE RG-59 CABLE CLIP WITH 1" NAIL
VCC-1102	BLACK RG-59 CABLE CLIP WITH 1" NAIL
VCC-2101	WHITE RG-6 CABLE CLIP WITH 1" NAIL
VCC-2102	BLACK RG-6 CABLE CLIP WITH 1" NAIL

CABLE BUSHINGS

ITEM #	DESCRIPTION
VCC-4104	WHITE RG-59 CABLE BUSHING
VCC-4103	BLACK RG-59 CABLE BUSHING
VCC-4101	WHITE RG-6 CABLE BUSHING
VCC-4102	BLACK RG-6 CABLE BUSHING



INDOOR MATCHING TRANSFORMER



OUTDOOR MATCHING TRANSFORMER W/#10 LEADS



OUTDOOR MATCHING TRANSFORMER W/TWIN-LEADS

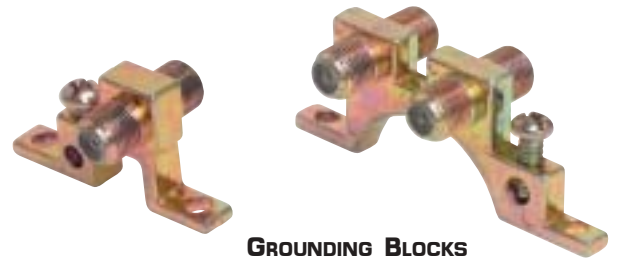

GROUNDING BLOCKS



CABLE CLIPS



FEED-THRU CABLE BUSHINGS



For connecting and patching video and audio signals, QUEST offers Video/Audio dubbing and S-VHS cable assemblies. The dubbing cables are available in various lengths and in mono or stereo configurations. They are manufactured with high-quality cables and each end is clearly marked with audio channels and video designations. The connector ends are gold plated for improved contact characteristics and over molded with cable strain reliefs. The S-VHS Mini-Din4 to Mini-Din4 cables also feature gold plated connectors and are made with high quality cable.

DUBBING CABLES

ITEM #	DESCRIPTION
VCA-4203	3' MONO VIDEO/AUDIO DUBBING CABLE 1 RCA-RCA FOR AUDIO, 1 RCA-RCA FOR VIDEO GOLD PLATED CONNECTORS
VCA-4206	6' MONO VIDEO/AUDIO DUBBING CABLE 1 RCA-RCA FOR AUDIO, 1 RCA-RCA FOR VIDEO GOLD PLATED CONNECTORS
VCA-4212	12' MONO VIDEO/AUDIO DUBBING CABLE 1 RCA-RCA FOR AUDIO, 1 RCA-RCA FOR VIDEO GOLD PLATED CONNECTORS
VCA-3203	3' STEREO VIDEO/AUDIO DUBBING CABLE 2 RCA-RCA FOR AUDIO, 1 RCA-RCA FOR VIDEO GOLD PLATED CONNECTORS
VCA-3206	6' STEREO VIDEO/AUDIO DUBBING CABLE 2 RCA-RCA FOR AUDIO, 1 RCA-RCA FOR VIDEO GOLD PLATED CONNECTORS
VCA-3212	12' STEREO VIDEO/AUDIO DUBBING CABLE 2 RCA-RCA FOR AUDIO, 1 RCA-RCA FOR VIDEO GOLD PLATED CONNECTORS

S-VHS CABLES

ITEM #	DESCRIPTION
VCA-5206	6' MINI-DIN4 MALE TO MINI-DIN4 MALE
VCA-5212	12' MINI-DIN4 MALE TO MINI-DIN4 MALE
VCA-5225	25' MINI-DIN4 MALE TO MINI-DIN4 MALE
VCA-5250	50' MINI-DIN4 MALE TO MINI-DIN4 MALE



MONO DUBBING CABLES



STEREO DUBBING CABLES



S-VHS CABLES



STEREO SHIELDED AUDIO CABLE



3.5MM MALE TO 2 RCA JACKS



1 RCA PLUG TO 2 RCA JACKS



2 RCA PLUGS TO 1 RCA JACK

For audio patching applications, QUEST offers a selection of mono and stereo cable assemblies as well as a selection of "Y" cables that allow splitting or combining audio channels. These are offered in various configurations and lengths.

AUDIO CABLES

ITEM #	DESCRIPTION
VCA-4106	6' MONO RCA MALE TO RCA MALE SHIELDED CABLE
VCA-4112	12' MONO RCA MALE TO RCA MALE SHIELDED CABLE
VCA-3103	3' STEREO RCA MALE TO RCA MALE SHIELDED CABLE
VCA-3106	6' STEREO RCA MALE TO RCA MALE SHIELDED CABLE
VCA-3112	12' STEREO RCA MALE TO RCA MALE SHIELDED CABLE
VCA-3125	25' STEREO RCA MALE TO RCA MALE SHIELDED CABLE

ADAPTER CABLES

ITEM #	DESCRIPTION
VCA-7010	Y CABLE - STEREO 3.5mm MINI PLUG TO TWO RCA JACKS - SHIELDED
VCA-7020	Y CABLE - 2 RCA MALE PLUGS TO 1 RCA JACK - SHIELDED
VCA-7030	Y CABLE - 1 RCA PLUG TO 2 RCA JACKS - SHIELDED



Mono Shielded Audio

VIDEO/DBS SATELLITE WALL PLATES

The QUEST series of flush-mounted video and satellite wall plates are offered with smooth finish faces for residential TV signal outlets. These include pre-installed feed through F connectors for connecting terminated F cables inside the box and externally for the hook-up. Most wall plates are offered in white and ivory and all fit into any standard single gang electrical box. Also offered are the dual combination wall plates with an RJ-11 4 contact telephone modular jack and F connector for video used in all DBS satellite connections.

ITEM #	DESCRIPTION
VWP-1101	F WALL PLATE - IVORY SMOOTH FINISH - WITH F-81 CONNECTOR
VWP-1102	F WALL PLATE - WHITE SMOOTH FINISH - WITH F-81 CONNECTOR
VWP-2102	DUAL F WALL PLATE - WHITE SMOOTH FINISH - WITH 2 F-81 CONNECTORS
NTP-1901	COMBO RJ-11 4C PHONE JACK WITH F-81 VIDEO CONNECTOR - IVORY - SMOOTH FINISH
NTP-1902	COMBO RJ-11 4C PHONE JACK WITH F-81 VIDEO CONNECTOR - WHITE - SMOOTH FINISH

**PLEASE SEE PAGES 70 AND 71 FOR
OUR FULL LINE OF DÉCOR STYLE
RESIDENTIAL HOME THEATER SERIES
WALL PLATES**



WALL PLATES WITH SINGLE F CONNECTOR



WALL PLATES WITH DUAL F CONNECTORS



COMBO 4C PHONE/F-81 WALL PLATES

AUDIO/VIDEO HOME THEATER

DÉCOR HOME THEATER SERIES WALL PLATES



1 PAIR BINDING POST



2 PAIR BINDING POST



1 PAIR BANANA JACKS



2 PAIR BANANA JACKS



DUAL RCA JACKS



TRIPLE RCA JACKS



1 F-81/DUAL RCA JACKS



1 F-81/TRIPLE RCA JACKS

Today's residential building environments are including pre-wiring for in-home data networking and home theater entertainment. QUEST provides a complete selection of décor style wall plates designed for home theater interconnects. All items are packaged complete with single gang faceplates.

ITEM #	DESCRIPTION
VHT-9000	1 PAIR BINDING POSTS - RED/BLACK - GOLD PLATED - WHITE - INCLUDES FACEPLATE
VHT-9010	2 PAIR BINDING POSTS - RED/BLACK - GOLD PLATED - WHITE - INCLUDES FACEPLATE
VHT-9020	1 PAIR BANANA JACKS - RED/BLACK - GOLD PLATED - WHITE - INCLUDES FACEPLATE
VHT-9030	2 PAIR BANANA JACKS - RED/BLACK - GOLD PLATED - WHITE - INCLUDES FACEPLATE
VHT-9040	DUAL RCA JACKS - RED/BLACK - GOLD PLATED - WHITE - INCLUDES FACEPLATE
VHT-9050	TRIPLE RCA JACKS - RED/BLACK - GOLD PLATED - WHITE - INCLUDES FACEPLATE
VHT-9060	2 RCA JACKS / 1 F-81 CONNECTOR - RCA JACKS CODED RED/BLACK-GOLD PLATED WHITE - INCLUDES FACEPLATE
VHT-9070	3 RCA JACKS / 1 F-81 CONNECTOR - RCA JACKS CODED RED/BLACK/YELLOW - GOLD PLATED WHITE - INCLUDES FACEPLATE

In addition to the line of Home Theater wall outlets, QUEST offers single, dual and triple gang faceplates where multiple outlets are required. These faceplates are also compatible with QUEST's modular keystone data/voice jack module on page 9.

ITEM #	DESCRIPTION
VHT-9080	SINGLE F GOLD PLATED VIDEO - WHITE - INCLUDES FACEPLATE
VHT-9090	DUAL F GOLD PLATED VIDEO - WHITE - INCLUDES FACEPLATE
VHT-9095	SINGLE UNLOADED 3-HOLE INSERT MODULE - WHITE - INCLUDES FACEPLATE
VHT-9100	SINGLE GANG DÉCOR FACEPLATE ONLY - WHITE
VHT-9200	DUAL GANG DÉCOR FACEPLATE ONLY - WHITE
VHT-9300	TRIPLE GANG DÉCOR FACEPLATE ONLY - WHITE



SINGLE F-81



DUAL F-81



SINGLE GANG FACEPLATE



UNLOADED INSERT
MODULE



TRIPLE GANG FACEPLATE



DUAL GANG FACEPLATE

**PLEASE SEE PAGE 69 FOR OTHER
VIDEO AND SATELLITE WALL PLATES**

ATM (Asynchronous transfer mode) Technology selected by ITU, for broadband ISDN. This communication framework is designated by the ATM forum for 155 Mb/s transmitted over twisted pair UTP (unshielded twisted pair) or STP (shielded twisted pair) cable and optical cabling at various bit rates for both LAN and WAN applications.

Attenuation Generally expressed in decibels, it is a measure of reduced power or amplitude of a transmitted signal.

ACR (Attenuation to Cross talk Ratio) The measured difference between attenuation and cross talk.

Cabling The part of the telecommunications infrastructure comprised of cables, wire, cords and connecting hardware.

Channel The entire path connecting any two points where specific application equipment is joined. The physical equipment and cabling at the work area is all part of the channel.

Coaxial Cable A cable type consisting of an inner conductor sheathed by an insulator that is sheathed by an outer shielding commonly used for CATV and MATV applications.

Cross Connect Also known as a distributor; the area allowing the termination of cabling and other interconnect products or cross-connections with other cabling or equipment.

Cross talk Generally expressed in decibels, the measured noise or interference effected by electromagnetic coupling from one path of signal to another.

Decibel (dB) A standard unit for expressing increased or decreased transmission strength as derived from a ratio of power or signal amplitudes.

Demarcation Point (DP) The point at which ownership or operational control changes.

ELFEXT (Equal Level Far-end Cross talk) Measured cross talk levels at the opposite end from the signal distribution point where signal is transmitted normalized by the contributed attenuation of the cabling.

FEXT (Far end Cross talk) Measured cross talk levels at the opposite end from the distribution point where signal is transmitted.

Gain A measure of amplification expressed in dB.

Gigahertz (GHz) One billion cycles per second. Signals operating above 3 Gigahertz are known as microwave.

Horizontal Cabling The inclusive cabling between the telecommunications outlet and the horizontal cross connect.

Link End to End transmission path supported by the cabling infrastructure. Links include all hardware and supporting cabling that makes up the backbone / horizontal subsystems. Work area and equipment cabling are not part of the link.

Modular Jack Typically mounted in a fixed location with 4, 6 or 8 contacts, a female type Telecommunications interface connector as specified in IEC 603-7 and FCC Part 68 Subpart F.

Modular Plug Having either 4, 6 or 8 contacts a male type Telecommunications interface connector as specified in IEC 603-7 and FCC Part 68 Subpart F.

Multimedia Communication of information by more than one type of cabling media. i.e. CATV, Satellite, Video...

MUTOA (Multi-user Telecommunications Outlet Assembly) One location serving several telecommunications outlet connections.

NEXT (Near end Cross talk) Measurement of cross talk taken at the end from where the signal is transmitted.

Patch Cord A length of cable joining telecommunications links at a cross-connect built with connectors at one or both ends.

Patch Panel A connection between horizontal and backbone cabling in a fixed arrangement that is accessible via patch cords or equipment cords to create a cross-connection or interconnection.

Power Sum 4 pair cable testing where the mathematical sum of pair-to-pair cross talk generated by 3 pairs to 1 pair is measured.

Return Loss Expressed in decibels, a measure of noise or interference caused by impedance discontinuities across the transmission line at different frequencies.

Telecommunications Sending, receiving, or emitting of any of an array of signal types including writings, images, sounds, or information of any type via cable, visual, optical or other electromagnetic systems.

UTP (Unshielded Twisted Pair) A multiple number of pairs of insulated copper conductors bound in a single sheath.

a

Active Network, Fiber Converters 21
 Active Network, Hubs 18, 19, 20
 Active Network, Interface Cards 19
 Active Network, Media Converters 21
 Active Network, Switches 18, 19, 20
 Active Network, Transceivers 21
 Adapters, RF Coax 46, 47, 48, 49

b

Bezels, Keystone 3, 8.
 Boxes, Surface Mount Telephone 29
 Boxes, Surface Mount Data 10, 11

c

Cabinets, Equipment.....26.
 Cable Assemblies, Audio Cables.....68.
 Cable Assemblies, Audio/Video Dubbing.....67
 Cable Assemblies, BNC to BNC.....66
 Cable Assemblies, F to F.....66
 Cable Assemblies, S-VHS.....67
 Cable Cutters.....53
 Cable Ties, Hook and Loop.....23
 Cables Ties, Nylon.....23
 CATV/MATV, A-B Switches.....63
 CATV/MATV, Cable Clips.....65
 CATV/MATV, Directional Taps.....61
 CATV/MATV, F Wall plates.....69
 CATV/MATV, Feed Through Bushing.....65
 CATV/MATV, Grounding Blocks.....65
 CATV/MATV, Decor Wall plates.....70, 71
 CATV/MATV, Matching Transformers.....65
 CATV/MATV, RF Modulators.....63
 CATV/MATV, Signal Combiners.....62
 CATV/MATV, Splitters.....60, 61
 CATV/MATV, Video Amplifiers.....64
 Computer, Cable Assemblies.....32, 33
 Computer, Switch Boxes.....31
 Connector to Tool Reference Chart.....59
 Connectors, BNC 50 OHM Crimp.....36, 37
 Connectors, BNC 75 OHM Series.....38
 Connectors, BNC Chassis Mount.....39
 Connectors, BNC PC Mount.....39
 Connectors, BNC Twist-On.....37
 Connectors, F Chassis Mount.....45
 Connectors, F PC Mount.....45
 Connectors, F Splices.....44
 Connectors, F.....43
 Connectors, Mini-UHF.....42
 Connectors, Modular.....42
 Connectors, N.....40
 Connectors, TNC.....42
 Connectors, Twin-Ax.....42
 Connectors, UHF.....41
 Couplers, C5e.....4
 Crimpers, Modular.....56, 57

d

D-Subminiature, Connectors 34
 D-Subminiature, Contacts 35
 D-Subminiature, Gender Changers 31
 D-Subminiature, Hardware 35
 D-Subminiature, Hoods 35
 D-Subminiature, Insertion Tool.....35

f

Faceplates, Angled Face 8
 Faceplates, Coax Stainless Steel 39
 Faceplates, Decor 9
 Faceplates, Iconable 7
 Faceplates, Keystone Standard 6
 Fiber Optic, Adapters 16
 Fiber Optic, Connectors 16
 Fiber Optic, Enclosures 17
 Fiber Optic, Ethernet Converters 21
 Fiber Optic, Panels 17
 Fiber Optic, Patch Cords 16
 Fiber Optic, Splice Trays 17
 Fiber Optic, Termination Tool Kit 59

i

Inserts, Faceplates 6

k

Keystone Jacks, C5e 4
 Keystone Jacks, Cat3, 4 5

m

Modular Adapters 13
 Modular Plugs 13

p

Patch Cords, CAT5e	12
Patch Cords, Fiber	16
Patch Panels, Blank	3
Patch Panels, C5e	2
Punch-Down Tools	55

w

Wall Brackets, 19"	25
Wire Strippers	54

r

Raceway Duct Accesories	22
Raceway Duct	22
Racks, Cable Management	25
Racks, Equipment Shelves	26
Racks, Equipment	24

t

Telephone, Cable Assemblies	30
Telephone, Cable	30
Telephone, Couplers	29
Telephone, Duplex Adapters	29
Telephone, Modular Connectors	13
Telephone, Surface Boxes	29
Telephone, Wall plates	28
Terminators, BNC	39
Terminators, F	44
Testers, Network	14
Tone Generators	15, 58
Tools, Cable Cutters	53
Tools, Coaxial Strippers	52
Tools, Compression F	50
Tools, D-Sub Insertion	35
Tools, F Crimpers	50, 51
Tools, Fiber Termination kit	59
Tools, Large O.D. Coax	50
Tools, Lineman's Butt Set	58
Tools, Modular Crimpers	56, 57
Tools, Network Kit	15
Tools, Punch-Down	55
Tools, Ratchet RF Coax	51
Tools, Tone Generators	15, 58
Tools, Wire Strippers	54
Tools, Wire Tie	53

3 PIECE BNC, TNC, MINI-UHF CRIMP STYLE.

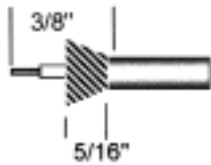

1. Strip cable as shown or use stripping tool TCS-5010.

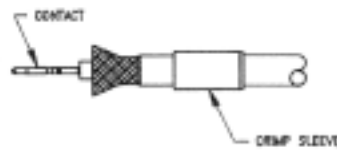

2. Crimp center contact with proper crimp tool as noted in the connector to tool cross found on page 59.



3. Slide ferrule up over back of body housing and over cable braid, and crimp ferrule with proper crimp tool found on page 59.

2 PIECE BNC CRIMP STYLE

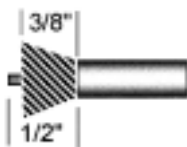

1. Strip cable as shown or use the TCS-5000 stripper. Remove all but 1/8" of dielectric.



2. Flare out braid completely and then feed the center conductor into the rear of the connector body.



3. Slide ferrule up over the body and braid and crimp with appropriate tool.

BNC ONE PIECE TWIST-ON

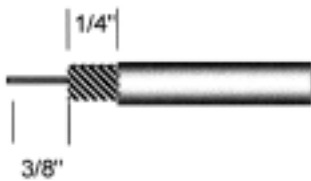

1. Strip cable as shown or use tool TCS-5020.

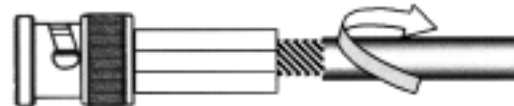

2. Twist center pin into connector body with a clockwise motion.
3. Twist onto cable jacket until fully threaded onto cable.

F ONE PIECE CRIMP STYLE.

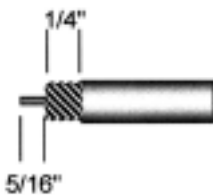

1. Strip cable as shown or use TCS-5020 stripping tool.



2. Push stripped cable into the connector until the cable dielectric is flush with the connector's center opening in the head of the connector.



3. Crimp body with tool specified in the connector to tool cross reference on page 59.

PART #	PAGE	PART #	PAGE	PART #	PAGE	PART #	PAGE
CAB-2000	38	CBN-2114	37	CNC-6123	40	NAP-2005	18
CAB-2005	38	CBN-2115	37	CNC-6223	40	NAP-2008	18
CAB-2015	38	CBN-2120	37	CNC-6224	40	NAP-2016	19
CAD-1000	46	CBN-2122	37	CRQ-6000	43	NAP-2024	20
CAD-1001	46	CBN-3105	36	CTN-2112	42	NAP-3008	18
CAD-1002	47	CBN-3110	36	CTW-1000	42	NAP-3016	20
CAD-1005	46	CBN-3111	36	CUF-6122	41	NAP-3024	20
CAD-1010	46	CBN-3112	36	CUF-6220	41	NAP-4010	19
CAD-1015	46	CBN-3113	36	CUF-6230	41	NAP-4110	19
CAD-1020	46	CBN-3114	36	CUF-6240	41	NAP-4120	21
CAD-1025	46	CBN-3116	36	CUF-9110	41	NAP-4130	21
CAD-1030	46	CBN-3118	36	CUF-9112	41	NAP-5012	21
CAD-1035	47	CBN-3120	36	CWP-1010	39	NAP-5015	21
CAD-1055	47	CBN-3121	36	CWP-1030	39	NBC-1503	66
CAD-1061	47	CBN-3210	36	DHA-2101	35	NBC-1506	66
CAD-1062	47	CBN-3212	36	DHA-2102	35	NBC-1512	66
CAD-1063	47	CBN-3214	36	DHA-2201	35	NBC-1703	66
CAD-1064	47	CBN-4030	39	DHA-2202	35	NBC-1706	66
CAD-1065	47	CBN-4031	39	DHA-3000	35	NBC-1712	66
CAD-1070	48	CBN-4032	39	DHA-5010	35	NBP-2016	3
CAD-1075	48	CBN-4033	39	DHA-5020	35	NBP-2024	3
CAD-1076	48	CBN-4034	39	DHA-5030	35	NBP-2048	3
CAD-1077	49	CBN-5150	39	DHA-5040	35	NBW-1426	30
CAD-1080	48	CBN-5175	39	DHA-5080	35	NBW-1626	30
CAD-1085	48	CBQ-7010	39	DHA-5090	35	NBW-1826	30
CAD-1090	48	CBQ-7011	39	DSC-1109	34	NBW-2428	30
CAD-1095	48	CBQ-8000	39	DSC-1115	34	NBW-2628	30
CAD-1100	48	CBQ-8001	39	DSC-1125	34	NBW-2828	30
CAD-1105	49	CFC-1111	43	DSC-1137	34	NCC-1106	32
CAD-1106	49	CFC-1114	43	DSC-1150	34	NCC-1110	32
CAD-1110	49	CFC-5175	44	DSC-1209	34	NCC-1206	32
CAD-1115	49	CFC-7111	43	DSC-1215	34	NCC-1210	32
CAD-1116	49	CFC-7112	43	DSC-1225	34	NCC-2206	32
CAD-1117	49	CFC-7114	43	DSC-1237	34	NCC-2210	32
CAD-1120	49	CFC-7115	43	DSC-1250	34	NCC-2910	33
CAD-1125	49	CFC-7118	43	DSC-2109	34	NCC-4006	33
CAD-1130	49	CFC-7119	43	DSC-2115	34	NCC-4010	33
CBB-1210	38	CFC-7123	43	DSC-2125	34	NCC-5206	33
CBB-1211	38	CFC-7124	43	DSC-2209	34	NCC-5210	33
CBB-1214	38	CFC-7125	43	DSC-2215	34	NCC-5506	32
CBB-1219	38	CFC-7214	43	DSC-2225	34	NCC-5510	32
CBB-1220	38	CFC-7314	43	DSC-3109	34	NCC-5525	32
CBB-2210	38	CFC-8110	43	DSC-3126	34	NCC-5606	32
CBB-2211	38	CFC-8114	43	DSC-3209	34	NCC-5610	32
CBB-2214	38	CFQ-9010	43	DSC-3226	34	NCC-5625	32
CBB-2219	38	CFS-0181	44	DSC-4115	34	NCC-5706	33
CBB-2220	38	CFS-0182	44	DSC-4126	34	NCC-5710	33
CBB-3210	38	CFS-0183	44	DSC-4215	34	NCC-5725	33
CBB-3211	38	CFS-0185	45	DSC-4226	34	NCC-7706	32
CBB-3214	38	CFS-0186	44	DSH-5109	35	NCC-7710	32
CBB-3219	38	CFS-0187	45	DSH-5115	35	NCC-7725	32
CBB-3220	38	CFS-0188	45	DSH-5125	35	NCC-9006	33
CBB-4233	38	CFS-0189	45	DSH-5137	35	NCC-9010	33
CBN-1110	37	CFS-0203	45	DSH-5150	35	NCC-9906	33
CBN-1111	37	CFS-0206	45	DSH-5309	35	NCC-9910	33
CBN-1112	37	CFS-0210	45	DSH-5315	35	NCO-4107	30
CBN-1114	37	CFS-0220	45	DSH-5325	35	NCO-4115	30
CBN-1115	37	CMU-3112	42	DSH-5409	35	NCO-4125	30
CBN-1116	37	CMU-3212	42	DSH-5415	35	NCO-6207	30
CBN-1117	37	CMU-3312	42	DSH-5425	35	NCO-6215	30
CBN-2110	37	CNC-3022	40	DSH-5615	35	NCO-6225	30
CBN-2111	37	CNC-3112	40	NAP-1005	18	NCO-8307	30
CBN-2112	37	CNC-6122	40	NAP-1008	18	NCO-8315	30

PART #	PAGE	PART #	PAGE	PART #	PAGE	PART #	PAGE
NCO-8325	30	NGC-1033	31	NMA-8109	13	NPC-1207	12
NFK-7000	59	NGC-1044	31	NMA-8209	13	NPC-1210	12
NFO-3021	16	NGC-1055	31	NMA-8309	13	NPC-1215	12
NFO-1006	17	NGC-1066	31	NMA-8409	13	NPC-1225	12
NFO-2000	17	NGC-2216	31	NMA-8509	13	NPC-1303	12
NFO-2001	17	NGC-2225	31	NMA-8609	13	NPC-1307	12
NFO-2003	17	NGC-2257	31	NMB-1001	13	NPC-1310	12
NFO-2004	17	NGC-3020	31	NMB-1002	13	NPC-1315	12
NFO-2006	17	NGC-3040	31	NMB-1003	13	NPC-1325	12
NFO-2007	17	NIN-1000	3,8	NMB-1005	13	NPC-1503	12
NFO-2009	17	NIN-1002	3,8	NMB-1006	13	NPC-1507	12
NFO-2010	17	NIN-1003	3,8	NMB-1008	13	NPC-1510	12
NFO-2012	17	NIN-1005	3,8	NMB-1009	13	NPC-1515	12
NFO-2013	17	NIN-1006	3,8	NMB-1010	13	NPC-1525	12
NFO-2014	17	NIN-1008	3,8	NMP-4111	13	NPC-1603	12
NFO-2015	17	NIN-1107	6	NMP-4221	13	NPC-1607	12
NFO-2016	17	NIN-1108	6,9	NMP-6111	13	NPC-1610	12
NFO-2017	17	NIN-1207	6	NMP-6221	13	NPC-1615	12
NFO-2018	17	NIN-1208	6,9	NMP-8111	13	NPC-1625	12
NFO-3000	16	NIN-1307	6	NMP-8215	13	NPC-1803	12
NFO-3001	16	NIN-1308	6,9	NMP-8225	13	NPC-1807	12
NFO-3002	16	NIN-1500	3,8	NMP-9000	13	NPC-1810	12
NFO-3012	16	NIN-1501	3,8	NPC-0103	12	NPC-1815	12
NFO-3013	16	NIN-1502	3,8	NPC-0107	12	NPC-1825	12
NFO-3014	16	NIN-1503	3,8	NPC-0110	12	NPC-1903	12
NFO-3015	16	NIN-1504	3,8	NPC-0115	12	NPC-1907	12
NFO-3016	16	NIN-2001	3	NPC-0125	12	NPC-1910	12
NFO-3017	16	NIN-2002	3	NPC-0203	12	NPC-1915	12
NFO-3018	16	NIN-2003	3	NPC-0207	12	NPC-1925	12
NFO-3019	16	NIN-2004	3	NPC-0210	12	NPP-1012	2
NFO-3020	16	NIN-2005	3	NPC-0215	12	NPP-1016	2
NFO-3022	16	NIN-2006	3	NPC-0225	12	NPP-1024	2
NFO-3023	16	NIN-2007	3	NPC-0303	12	NPP-1048	2
NFO-3024	16	NIN-2008	3	NPC-0307	12	NRS-1801	22
NFO-3025	16	NIN-3002	3	NPC-0310	12	NRS-1805	22
NFP-1017	6	NIN-3003	3	NPC-0315	12	NRS-2801	22
NFP-1018	6	NIN-3005	3	NPC-0325	12	NRS-2805	22
NFP-1027	6	NIN-3006	3	NPC-0503	12	NRS-3001	22
NFP-1028	6	NIN-3008	3	NPC-0507	12	NRS-3005	22
NFP-1037	6	NKJ 5001	4	NPC-0510	12	NRS-3011	22
NFP-1038	6	NKJ-4601	5	NPC-0515	12	NRS-3015	22
NFP-1047	6	NKJ-4608	5	NPC-0525	12	NRS-3021	22
NFP-1048	6	NKJ-4801	5	NPC-0603	12	NRS-3025	22
NFP-1067	6	NKJ-5101	4	NPC-0607	12	NRS-3031	22
NFP-1068	6	NKJ-5102	4	NPC-0610	12	NRS-3035	22
NFP-2017	7	NKJ-5103	4	NPC-0615	12	NRS-3041	22
NFP-2018	7	NKJ-5104	4	NPC-0625	12	NRS-3045	22
NFP-2027	7	NKJ-5105	4	NPC-0803	12	NRS-3051	22
NFP-2028	7	NKJ-5106	4	NPC-0807	12	NRS-3055	22
NFP-2047	7	NKJ-5107	4	NPC-0810	12	NRS-3062	22
NFP-2048	7	NKJ-5108	4	NPC-0815	12	NRS-3091	22
NFP-2067	7	NKJ-5201	4	NPC-0825	12	NRS-3095	22
NFP-2068	7	NKJ-5202	4	NPC-0903	12	NRS-4001	22
NFP-3000	8	NKJ-5203	4	NPC-0907	12	NRS-4005	22
NFP-3018	8	NKJ-5204	4	NPC-0910	12	NSB-5100	10
NFP-3028	8	NKJ-5205	4	NPC-0915	12	NSB-5110	10
NFP-3048	8	NKJ-5206	4	NPC-0925	12	NSB-5120	10
NFP-4011	9	NKJ-5207	4	NPC-1103	12	NSB-5130	10
NFP-4012	9	NKJ-5208	4	NPC-1107	12	NSB-5150	11
NFP-4013	9	NMA-6109	13	NPC-1110	12	NSB-5151	11
NFP-4014	9	NMA-6209	13	NPC-1115	12	NSB-5160	11
NGC-1011	31	NMA-6509	13	NPC-1125	12	NSB-5161	11
NGC-1022	31	NMA-6609	13	NPC-1203	12	NSB-5170	11

PART #	PAGE	PART #	PAGE	PART #	PAGE	PART #	PAGE
NSB-5171	11	NWM-0701	24	TRF-3001	51	VFC-1103	66
NSB-6140	11	NWM-0702	24	TRF-3010	51	VFC-1106	66
NSB-6240	11	NWM-1000	26	TRF-3015	51	VFC-1112	66
NTB-1401	29	NWM-1011	26	TRF-3020	51	VFC-1125	66
NTB-1402	29	NWM-1012	26	TRF-3030	51	VFC-1150	66
NTB-1601	29	NWM-1021	26	TRF-3035	51	VFC-1203	66
NTB-1602	29	NWM-1022	26	TRF-3040	51	VFC-1206	66
NTB-1801	29	NWM-1032	26	TRF-3045	51	VFC-1212	66
NTB-1802	29	NWM-2001	25	TRF-3050	51	VFC-1225	66
NTB-2401	29	NWM-2002	25	TRF-3051	51	VFC-1250	66
NTB-2402	29	NWM-3002	25	TRF-3052	51	VFC-2103	66
NTB-3401	29	NWM-3004	25	TRF-3054	51	VFC-2106	66
NTB-3402	29	NWM-3006	25	TRF-3056	51	VFC-2112	66
NTB-3601	29	NWM-4000	24	TSB-5021	52	VFC-2125	66
NTB-3602	29	NWM-4001	24	TSB-5022	52	VFC-2150	66
NTC-1421	29	NWT-4081	23	TSB-5023	52	VFC-2203	66
NTC-1422	29	NWT-4088	23	TTE-2000	58	VFC-2206	66
NTC-1621	29	NWT-4111	23	TTE-2100	58	VFC-2212	66
NTC-1622	29	NWT-4118	23	TTE-2101	58	VFC-2225	66
NTC-1821	29	NWT-4141	23	TTE-2102	58	VFC-2250	66
NTC-1822	29	NWT-4148	23	TTE-9000	14	VGB-1001	65
NTC-2421	29	NWT-4200	23	TTE-9010	14	VGB-1002	65
NTC-2422	29	NWT-4210	23	TTE-9020	14	VHT-9000	70
NTC-2621	29	NWT-8041	23	TTE-9030	14	VHT-9010	70
NTC-2622	29	NWT-8048	23	TTE-9040	14	VHT-9020	70
NTC-2821	29	NWT-8081	23	VAB-1000	63	VHT-9030	70
NTC-2822	29	NWT-8088	23	VAB-2000	63	VHT-9040	70
NTP-1441	28	TCS-5000	52	VAM-1412	64	VHT-9050	70
NTP-1442	28	TCS-5010	52	VAM-2110	64	VHT-9060	70
NTP-1601	28	TCS-5020	52	VAM-2125	64	VHT-9070	70
NTP-1602	28	TCS-5030	52	VAM-2130	64	VHT-9080	71
NTP-1661	28	TCS-5040	52	VAM-4000	64	VHT-9090	71
NTP-1662	28	TCS-5120	52	VCA-3103	68	VHT-9095	71
NTP-1801	28	TEL-6000	57	VCA-3106	68	VHT-9100	71
NTP-1802	28	TEL-6001	57	VCA-3112	68	VHT-9200	71
NTP-1881	28	TEL-6020	57	VCA-3125	68	VHT-9300	71
NTP-1882	28	TEL-6030	56	VCA-3203	67	VMT-1000	65
NTP-1901	28,69	TEL-6040	56	VCA-3206	67	VMT-2000	65
NTP-1902	28,69	TEL-6050	56	VCA-3212	67	VMT-3000	65
NTP-2401	28	TEL-6070	55	VCA-4106	68	VSP-1210	60
NTP-2402	28	TEL-6080	55	VCA-4112	68	VSP-1220	60
NTP-4401	28	TEL-6085	55	VCA-4203	67	VSP-1320	60
NTP-4402	28	TEL-6090	55	VCA-4206	67	VSP-1420	60
NVT-0191	23	TEL-6097	55	VCA-4212	67	VSP-1620	60
NVT-0192	23	TEL-6098	55	VCA-5206	67	VSP-1820	60
NVT-0193	23	TEL-6099	55	VCA-5212	67	VSP-2220	61
NVT-0321	23	TEL-6100	52	VCA-5225	67	VSP-2320	61
NVT-1101	23	TEL-6110	55	VCA-5250	67	VSP-2420	61
NVT-1130	23	TEL-6120	55	VCA-7010	68	VSP-3000	62
NVT-1131	23	TFC-4000	50	VCA-7020	68	VTP-1106	61
NVT-1132	23	TFC-4010	50	VCA-7030	68	VTP-1109	61
NVT-1133	23	TFC-4020	50	VCC-1101	65	VTP-1112	61
NVT-1201	23	TFC-4030	50	VCC-1102	65	VTP-1116	61
NVT-1801	23	TFC-4035	50	VCC-2101	65	VTP-1120	61
NVT-3401	23	TFC-4040	50	VCC-2102	65	VTP-1124	61
NVT-3402	23	TMI-1015	53	VCC-4101	65	VTP-1127	61
NVT-3403	23	TMI-1020	54	VCC-4102	65	VTP-1130	61
NVT-3461	23	TMI-1021	54	VCC-4103	65	VTP-3010	62
NVT-3801	23	TMI-1025	54	VCC-4104	65	VTP-3020	62
NVT-3802	23	TMI-1030	53	VCO-1003	62	VWP-1101	69
NVT-3803	23	TMI-1031	53	VCO-1004	62	VWP-1102	69
NWM-0401	24	TMI-1040	53	VCO-1100	63	VWP-2102	69
NWM-0402	24	TRF-3000	51	VCO-1110	63		