

## VDR Metal Oxide Varistors Ultra Surge High Operating Temperature 125 °C

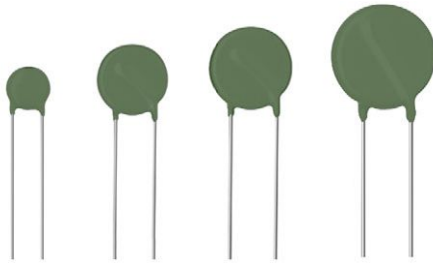

QUICK REFERENCE DATA		
PARAMETER	VALUE	UNIT
Maximum continuous voltage in operating temperature range:		
RMS	115 to 680	V
DC	150 to 895	V
Maximum non-repetitive transient current $I_{NRP}$ (8 x 20 $\mu$ s)	1800 to 13 000	A
Maximum energy (10/1000 $\mu$ s)	19 to 720	J
Detailed specification	Based on IEC 61051-1 IEC 61051-2 IEC 61051-2-2	
Storage temperature	-40 to +150	°C
Operating temperature	-40 to +125	°C

### ORDERING INFORMATION

The varistors are available in a number of packaging options:

- Bulk
- On tape on reel
- On tape in ammpack

The basic ordering code for each option is given in tables titled Varistors on Tape on Reel, Varistors on Tape in Ammpack, and Varistors in Bulk. To complete the catalog number and to determine the required operating parameters, see Electrical Data and Ordering Information table.

#### Note

- Special lead-configuration as inside or outside crimped leads available upon request

### FEATURES

- Low  $\beta$  high purity zinc oxide disc
- Halogen free high temperature resistant silicone coated
- Straight or kinked leads
- Ultra high current surge/size ratio capability up to 13 kA for US20 types
- Certified for operation up to 125 °C according to UL 1449 edition 4, VDE/IEC 61051-1/2
- Material categorization: for definitions of compliance please see [www.vishay.com/doc?99912](http://www.vishay.com/doc?99912)



### APPLICATION

- Overvoltage and transient voltage protection

### DESCRIPTION

The varistors consist of a disc of low- $\beta$  ceramic material with two solid copper leads (US20 types only) or copper clad steel wire. The wires have a matte tin plating. They are coated with UL94-V0 approved silicone lacquer, which provides electrical, mechanical and climatic protection.

### MOUNTING

The varistors are suitable for hand-mounting (bulk) or automatic pick and place mounting (T and R). The parts can be connected by wave soldering and pin-in-paste reflow soldering under defined process conditions. Bending of the leads for different angle placement is not recommended.

#### Typical Soldering

235 °C, duration: 5 s (Pb-bearing)

245 °C, duration: 5 s (lead (Pb)-free)

#### Resistance to Soldering Heat

260 °C; duration: 10 s max.

### MARKING

The varistors are marked with the following information:

- Maximum continuous RMS voltage with - U suffix
- Series numbers
  - 572 for VDRUS07
  - 573 for VDRUS10
  - 575 for VDRUS14
  - 576 for VDRUS20
- Manufacture logo
- Date of manufacture (YYWW)
- Safety marks on VDRUS10-14-20 types

### INFLAMMABILITY

The varistors are passive non-flammable. The encapsulation is made of flame resistant silicone in accordance with UL 94 V-0.



ELECTRICAL DATA AND ORDERING INFORMATION											
MAXIMUM CONTINUOUS VOLTAGE		VOLTAGE AT 1 mA <sup>(3)</sup>	MAXIMUM VOLTAGE AT STATED CURRENT		MAXIMUM ENERGY <sup>(4)</sup> (10 x 1000 µs)	MAXIMUM NON-REP. TRANSIENT CURRENT <sup>(5)</sup> I <sub>NRP</sub> (8 x 20 µs)	NOMINAL DISCHARGE CURRENT <sup>(7)</sup>	TYPICAL CAPACITANCE AT 1 kHz	T (MAX.)	E	CATALOG NUMBERS <sup>(1)</sup>
RMS <sup>(2)</sup> (V)	DC (V)	(V)	V (V)	I (A)	(J)	(A)	(kA)	(pF)	(mm)	(mm)	SAP <sup>(6)</sup>
115	150	180	300	10.0	19	1800	1	390	3.6	0.9 ± 0.3	VDRUS07M115xyE
			300	25.0	47	4500	2	680	4.0	1.1 ± 0.3	VDRUS10T115xyE
			300	50.0	65	8000	3	1320	4.0	1.1 ± 0.3	VDRUS14X115xyE
			300	100.0	152	13 000	5	2640	4.4	1.3 ± 0.3	VDRUS20Z115ByE
130	170	205	340	10.0	21	1800	1	320	3.8	1.0 ± 0.3	VDRUS07M130xyE
			340	25.0	52	4500	2	580	4.3	1.2 ± 0.3	VDRUS10T130xyE
			340	50.0	82	8000	3	1050	4.3	1.2 ± 0.3	VDRUS14X130xyE
			340	100.0	175	13 000	5	2100	4.8	1.4 ± 0.3	VDRUS20Z130ByE
140	180	220	360	10.0	23	1800	1	290	3.9	1.0 ± 0.3	VDRUS07M140xyE
			360	25.0	58	4500	2	540	4.3	1.2 ± 0.3	VDRUS10T140xyE
			360	50.0	90	8000	3	950	4.3	1.2 ± 0.3	VDRUS14X140xyE
			360	100.0	185	13 000	5	1900	4.8	1.5 ± 0.3	VDRUS20Z140ByE
150	200	240	395	10.0	25	1800	1	270	4.1	1.1 ± 0.3	VDRUS07M150xyE
			395	25.0	64	4500	2	490	4.3	1.3 ± 0.3	VDRUS10T150xyE
			395	50.0	98	8000	3	850	4.3	1.3 ± 0.3	VDRUS14X150xyE
			395	100.0	198	13 000	5	1700	4.8	1.5 ± 0.3	VDRUS20Z150ByE
175	225	275	455	10.0	28	1800	1	230	4.1	1.3 ± 0.3	VDRUS07M175xyE
			455	25.0	67	4500	2	430	4.5	1.5 ± 0.3	VDRUS10T175xyE
			455	50.0	116	8000	3	750	4.5	1.5 ± 0.3	VDRUS14X175xyE
			455	100.0	220	13 000	5	1500	4.9	1.7 ± 0.3	VDRUS20Z175ByE
195	250	300	505	10.0	32	1800	1	210	4.3	1.4 ± 0.8	VDRUS07M195xyE
			505	25.0	70	4500	2	380	4.8	1.6 ± 0.8	VDRUS10T195xyE
			505	50.0	128	8000	3	690	4.8	1.6 ± 0.8	VDRUS14X195xyE
			505	100.0	245	13 000	5	1350	5.1	1.9 ± 0.8	VDRUS20Z195ByE
210	275	330	550	10.0	34	1800	1	190	4.4	1.6 ± 0.8	VDRUS07M210xyE
			550	25.0	72	4500	2	350	4.8	1.8 ± 0.8	VDRUS10T210xyE
			550	50.0	140	8000	3	610	4.8	1.8 ± 0.8	VDRUS14X210xyE
			550	100.0	268	13 000	5	1250	5.3	2.0 ± 0.8	VDRUS20Z210ByE
230	300	360	595	10.0	37	1800	1	170	4.6	1.7 ± 0.8	VDRUS07M230xyE
			595	25.0	76	4500	2	320	5.1	1.9 ± 0.8	VDRUS10T230xyE
			595	50.0	158	8000	3	540	5.1	1.9 ± 0.8	VDRUS14X230xyE
			595	100.0	315	13 000	5	1100	5.4	2.2 ± 0.8	VDRUS20Z230ByE
250	320	390	650	10.0	40	1800	1	160	4.8	1.9 ± 0.8	VDRUS07M250xyE
			650	25.0	82	4500	2	300	5.1	2.1 ± 0.8	VDRUS10T250xyE
			650	50.0	170	8000	3	480	5.1	2.1 ± 0.8	VDRUS14X250xyE
			650	100.0	350	13 000	5	960	5.5	2.3 ± 0.8	VDRUS20Z250ByE
275	350	430	710	10.0	46	1800	1	140	4.9	2.0 ± 0.8	VDRUS07M275xyE
			710	25.0	93	4500	2	270	5.3	2.2 ± 0.8	VDRUS10T275xyE
			710	50.0	185	8000	3	440	5.3	2.2 ± 0.8	VDRUS14X275xyE
			710	100.0	380	13 000	5	900	5.8	2.5 ± 0.8	VDRUS20Z275ByE
300	385	470	775	10.0	49	1800	1	130	5.1	2.2 ± 0.8	VDRUS07M300xyE
			775	25.0	99	4500	2	240	5.5	2.4 ± 0.8	VDRUS10T300xyE
			775	50.0	205	8000	3	400	5.5	2.4 ± 0.8	VDRUS14X300xyE
			775	100.0	405	13 000	5	810	5.9	2.7 ± 0.8	VDRUS20Z300ByE
320	420	510	842	10.0	54	1800	1	120	5.5	2.4 ± 0.8	VDRUS07M320xyE
			842	25.0	107	4500	2	220	6.0	2.6 ± 0.8	VDRUS10T320xyE
			842	50.0	220	8000	3	370	6.0	2.6 ± 0.8	VDRUS14X320xyE
			842	100.0	445	13 000	5	750	6.3	2.9 ± 0.8	VDRUS20Z320ByE





**ELECTRICAL CHARACTERISTICS**

ELECTRICAL DATA		
PARAMETER	VALUE	UNIT
Maximum continuous voltage:		
RMS	115 to 680	V
DC	150 to 895	V
Maximum non-repetitive transient current ( $I_{NRP}$ ) ( $8 \times 20 \mu s$ )		
VDRUS07	1800	A
VDRUS10	4500	A
VDRUS14	8000	A
VDRUS20	13 000	A
Thermal resistance:		
VDRUS07	$\approx 70$	K/W
VDRUS10	$\approx 60$	K/W
VDRUS14	$\approx 50$	K/W
VDRUS20	$\approx 40$	K/W
Maximum dissipation:		
VDRUS07	250	mW
VDRUS10	400	mW
VDRUS14	600	mW
VDRUS20	1000	mW
Temperature coefficient of voltage at 1 mA maximum	$\pm 0.05$	%/K
Voltage proof between interconnected leads and case	1000	V
Storage temperature	-40 to +150	$^{\circ}C$
Operating temperature	-40 to +125	$^{\circ}C$

**DERATING CURVE**

Maximum Voltage  
Maximum Dissipation  
Maximum Energy  
Maximum Transient Current

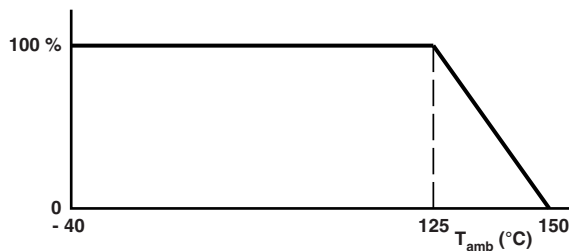

**PEAK CURRENT AS A FUNCTION OF PULSE WIDTH**

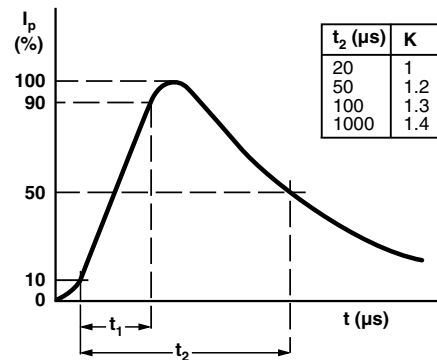

COMPONENT DIMENSIONS (BULK TYPE) in millimeters AND CATALOG NUMBERS												
D MAX.		A MAX.		A <sub>0</sub> MAX.		L MIN.	T <sup>(1)</sup> MAX.	E <sup>(1)</sup>	d	F	CATALOG NUMBER	MARKING NUMBER
V ≤ 320 V	V > 320 V	V ≤ 300 V	V > 300 V	V ≤ 320 V	V > 320 V							
9.0		11.0		13.0		24.0	6.5	0.7 to 3.6	0.6 ± 0.05	5 ± 1.0	VDRUS07	572
12.0	12.5	14.5	15.0	16.5	17.0	24.0	8.0	0.9 to 4.5	0.8 ± 0.05	7.5 ± 1.0	VDRUS10	573
16.0	16.5	19.0		21.0	21.5	24.0	8.0	0.9 to 4.5	0.8 ± 0.05	7.5 ± 1.0	VDRUS14	575
22.5	23.0	25.5		27.5	28.0	24.0	10.0	1.1 to 5.8	1.0 ± 0.05	10 ± 1.0	VDRUS20	576

**Note**

<sup>(1)</sup>  $T_{max}$ , and E values per size and voltage level can be found back in the Electrical Data table



VARISTORS IN BULK				
TYPE	VDRUS07 Ø 7 mm 115 V to 510 V	VDRUS10 Ø 10 mm 115 V to 680 V	VDRUS14 Ø 14 mm 115 V to 680 V	VDRUS20 Ø 20 mm 115 V to 680 V
Straight leads; see outline of components with straight leads drawing	BSE	BSE	BSE	BSE
Kinked leads; see outline of components with kinked leads drawing	BKE	BKE	BKE	BKE
<b>Packaging quantities</b>				
115 V to 385 V	250	250	100	50
420 V to 460 V	250	200	100	50
485 V to max. V	250	150	100	50

**DIMENSIONS** in millimeters: See Component Dimensions and Electrical Data table

**OUTLINE** of Component with Straight Leads

**OUTLINE** of Component with Kinked Leads

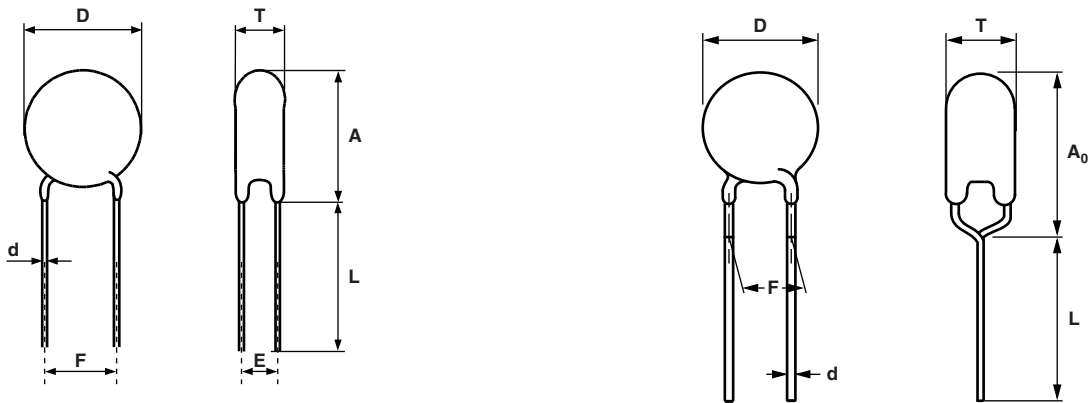

<b>VARISTORS ON TAPE IN AMMOPACK</b>			
<b>TYPE</b>	<b>VDRUS07 Ø 7 mm 115 V to 510 V</b>	<b>VDRUS10 Ø 10 mm 115 V to 550 V</b>	<b>VDRUS14 Ø 14 mm 115 V to 550 V</b>
Straight leads H = 18 mm H = 20 mm See drawing: taped version with straight leads	- ASE	- ASE	ASE -
Kinked leads H <sub>0</sub> = 18.25 mm H <sub>0</sub> = 16 mm See drawing: taped version with kinked leads	AME ALE	AME ALE	AME ALE
<b>Packaging quantities</b>			
115 V to 210 V	1500	1500	500
230 V to 510 V	1000	1000	500
550 V	-	800	400

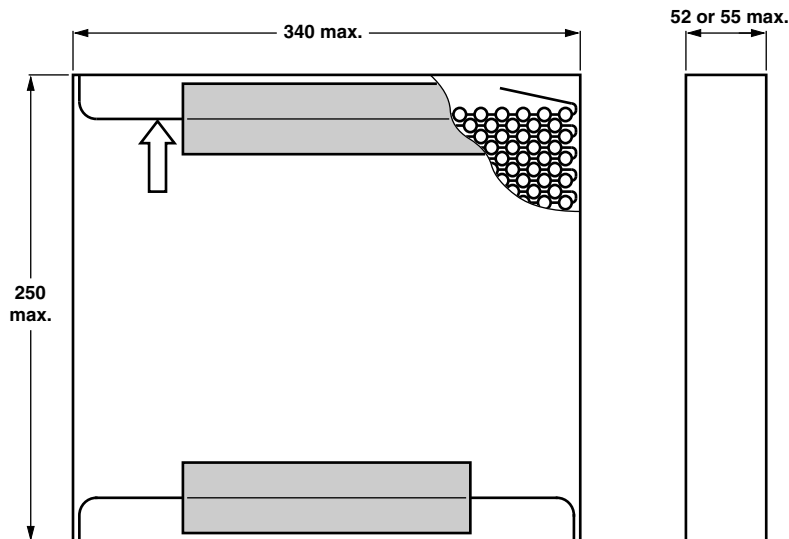
**DIMENSIONS OF AMMOPACK** in millimeters

<b>VARISTORS ON TAPE AND REEL</b>			
<b>TYPE</b>	<b>VDRUS07 Ø 7 mm 115 V to 510 V</b>	<b>VDRUS10 Ø 10 mm 115 V to 550 V</b>	<b>VDRUS14 Ø 14 mm 115 V to 550 V</b>
Straight leads H = 18 mm H = 20 mm See drawing: taped version with straight leads	- TSE	- TSE	TSE -
Kinked leads H <sub>0</sub> = 18.25 mm H <sub>0</sub> = 16 mm See drawing: taped version with kinked leads	TME TLE	TME TLE	TME TLE
<b>Packaging quantities</b>			
115 V to 250 V	1500	1500	1000
275 V to 300 V	1500	1500	750
320 V to 350 V	1000	1000	500
385 V to max. V	1000	1000	500

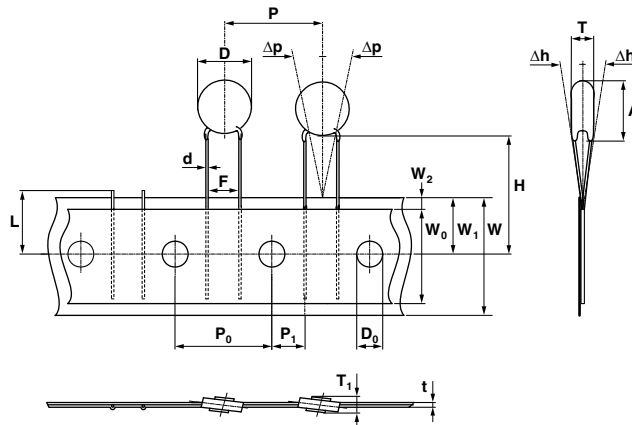
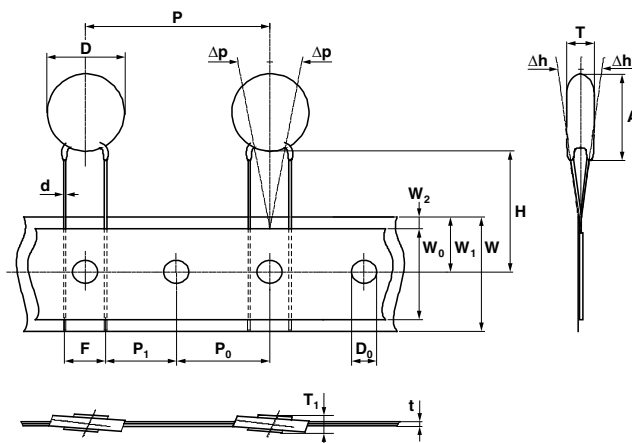
**PACKAGING**
**TAPED VERSION WITH STRAIGHT LEADS** (only for VDRUS07)

**TAPED VERSION WITH STRAIGHT LEADS** (only for VDRUS10 and VDRUS14)

**TAPED VERSION WITH KINKED LEADS**

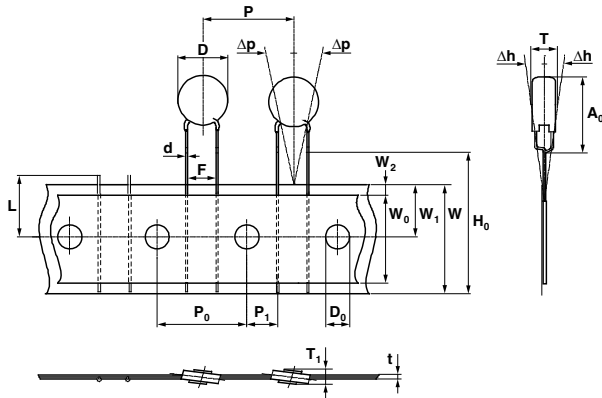
(only for VDRUS07)

**TAPED VERSION WITH KINKED LEADS**

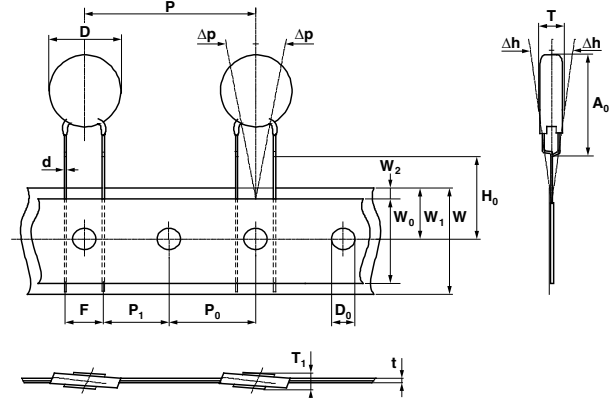
(only for VDRUS10 and VDRUS14)



<b>TAPING DATA</b> (based on IEC 60286-2)					
SYMBOL	PARAMETER		DIMENSIONS/TOLERANCE		
			VDRUS07	VDRUS10	VDRUS14
A max.	Max. mounting height	$V \leq 300\text{ V}$	11.0	14.5	19.0
		$V > 300\text{ V}$		15.0	
$A_0$ max.	Max. mounting height	$V \leq 320\text{ V}$	13.0	16.5	21.0
		$V > 320\text{ V}$		17.0	
D max.	Max. body diameter	$V \leq 320\text{ V}$	9.0	12.0	16.0
		$V > 320\text{ V}$		12.5	
d	Lead wire diameter		$0.6 \pm 0.05$	$0.8 \pm 0.05$	
F	Lead to lead distance <sup>(1)</sup>		$5.0 + 0.8/- 0.2$	$7.5 \pm 0.8$	
H	Distance component to tape center <sup>(2)</sup>		$20.0 + 2.0/- 0.0$	$18.0 + 2.0/- 0.0$	
$H_0$	Lead wire clinch height		16.0 or $18.25 \pm 0.5$		
P	Pitch of components on tape		$12.7 \pm 1.0$	$25.4 \pm 1.0$	
T	Total thickness		See Electrical Data table		

**Notes**

- (1) Guaranteed between component and tape  
 (2) For VDRUS14X510xSE and VDRUS14X550xSE:  $H = 20\text{ mm} \pm 1\text{ mm}$





## V/I CHARACTERISTICS

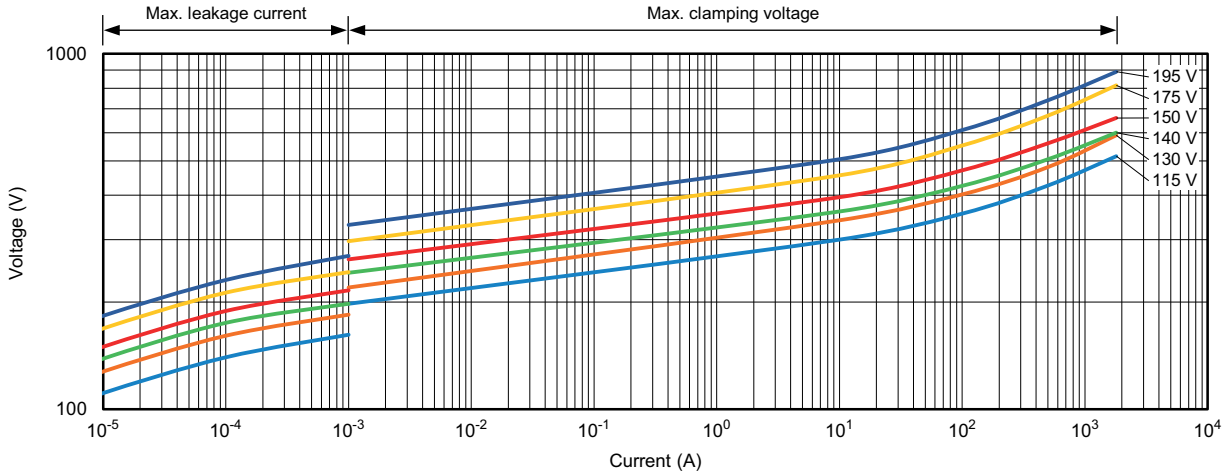

115 V<sub>RMS</sub> to 195 V<sub>RMS</sub>; VDRUS07

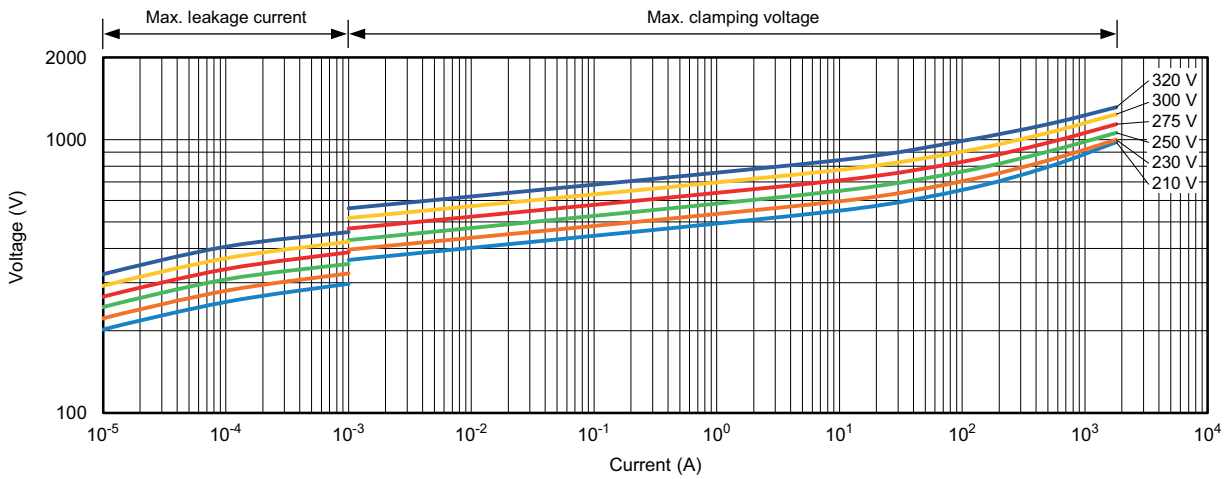

210 V<sub>RMS</sub> to 300 V<sub>RMS</sub>; VDRUS07

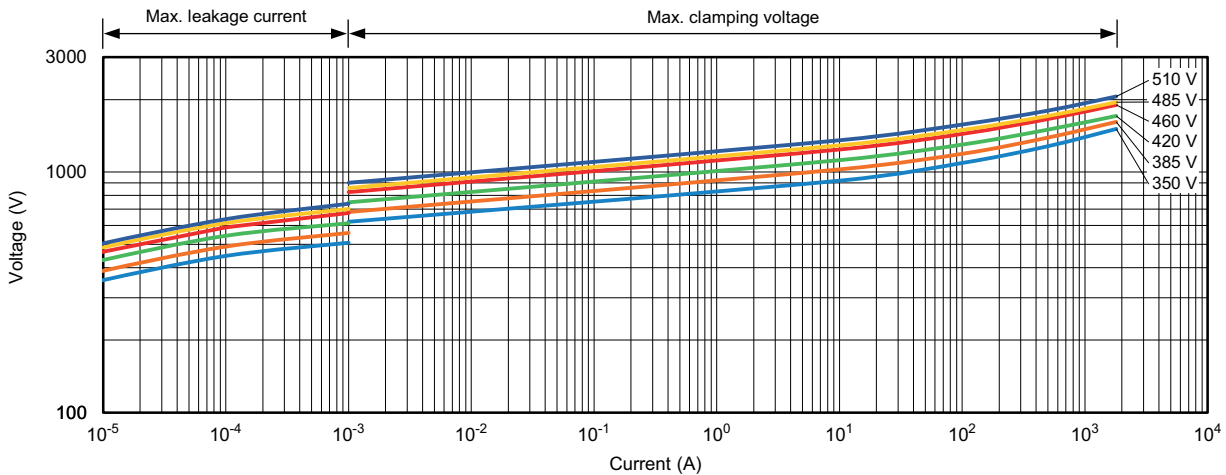

350 V<sub>RMS</sub> to 510 V<sub>RMS</sub>; VDRUS07



## V/I CHARACTERISTICS

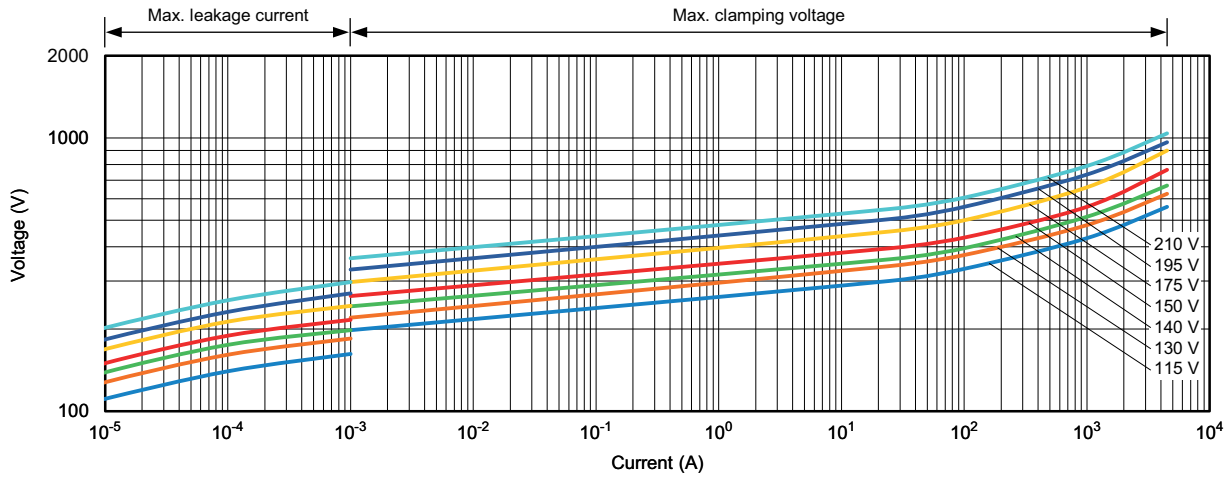

115 V<sub>RMS</sub> to 210 V<sub>RMS</sub>; VDRUS10

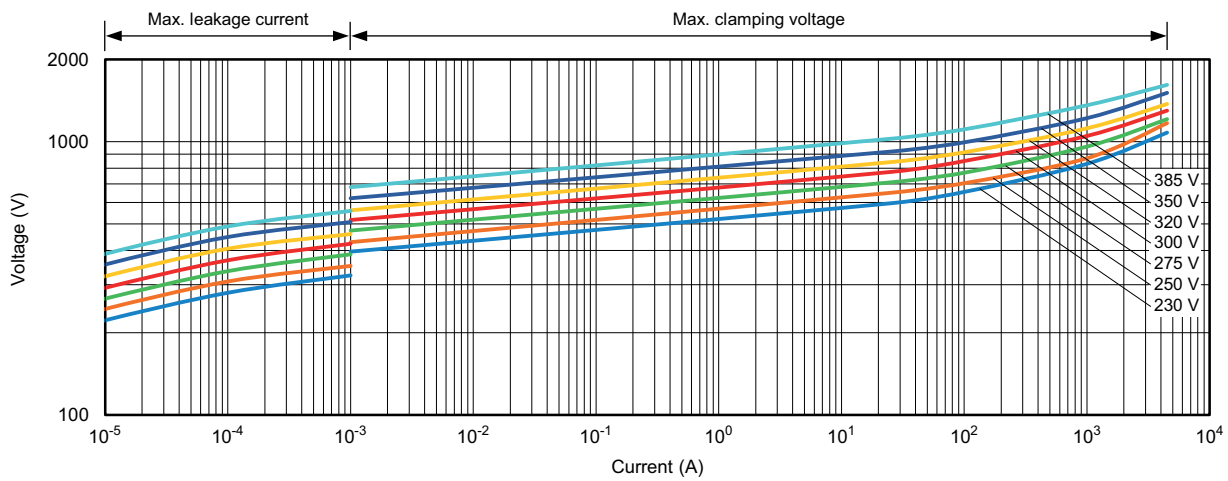

230 V<sub>RMS</sub> to 385 V<sub>RMS</sub>; VDRUS10

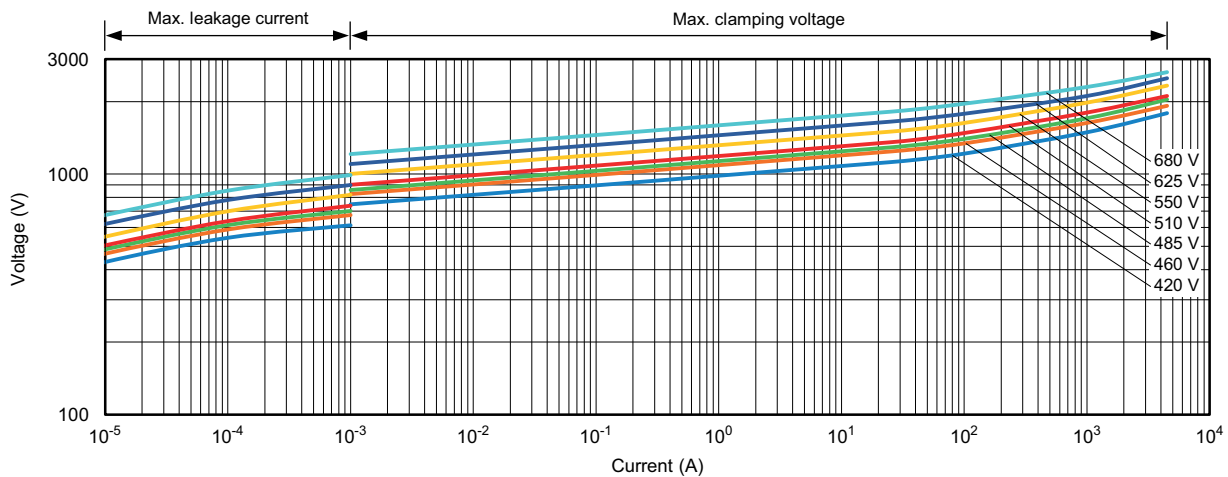

420 V<sub>RMS</sub> to 680 V<sub>RMS</sub>; VDRUS10



V/I CHARACTERISTICS

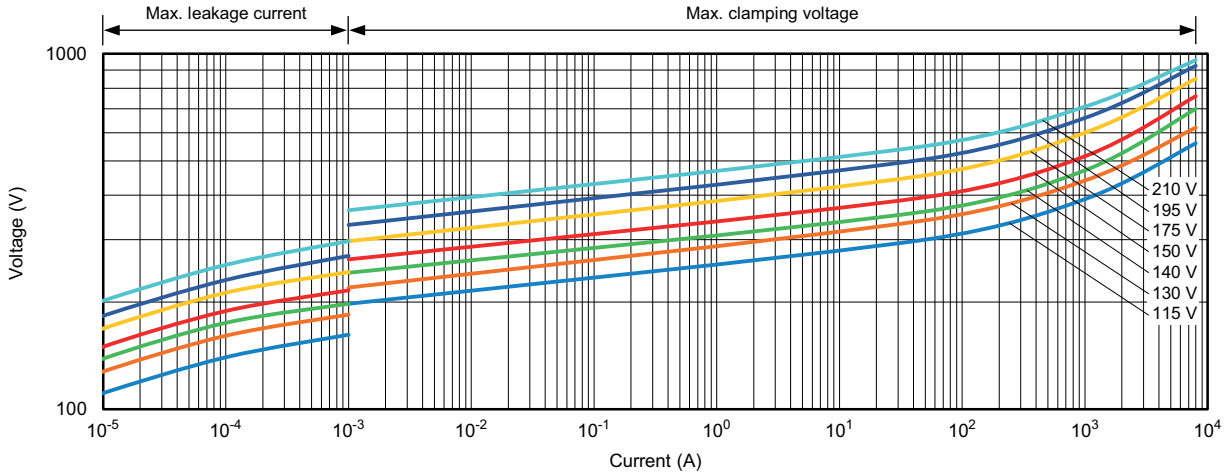

115 V<sub>RMS</sub> to 210 V<sub>RMS</sub>; VDRUS14

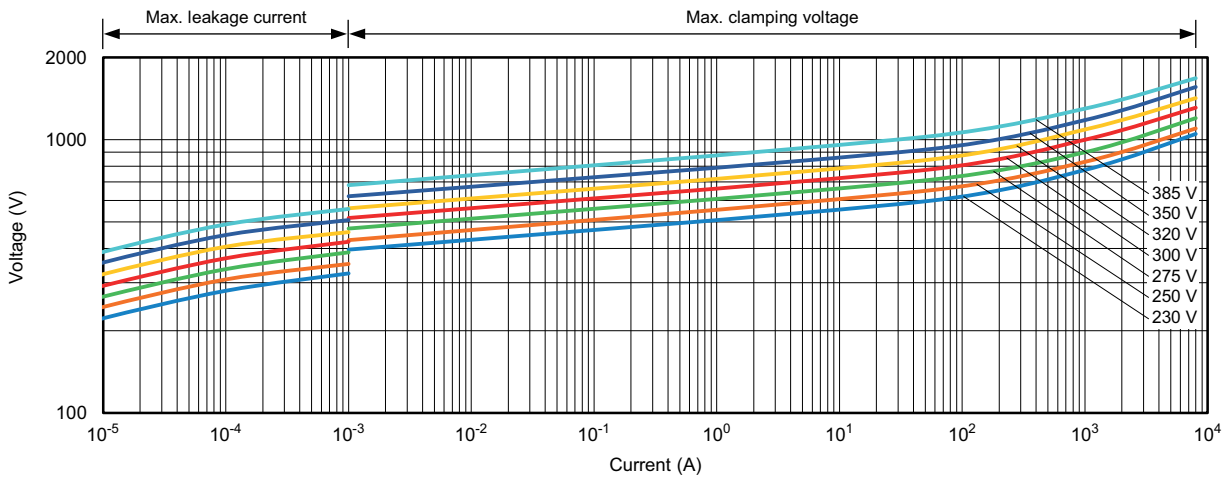

230 V<sub>RMS</sub> to 385 V<sub>RMS</sub>; VDRUS14

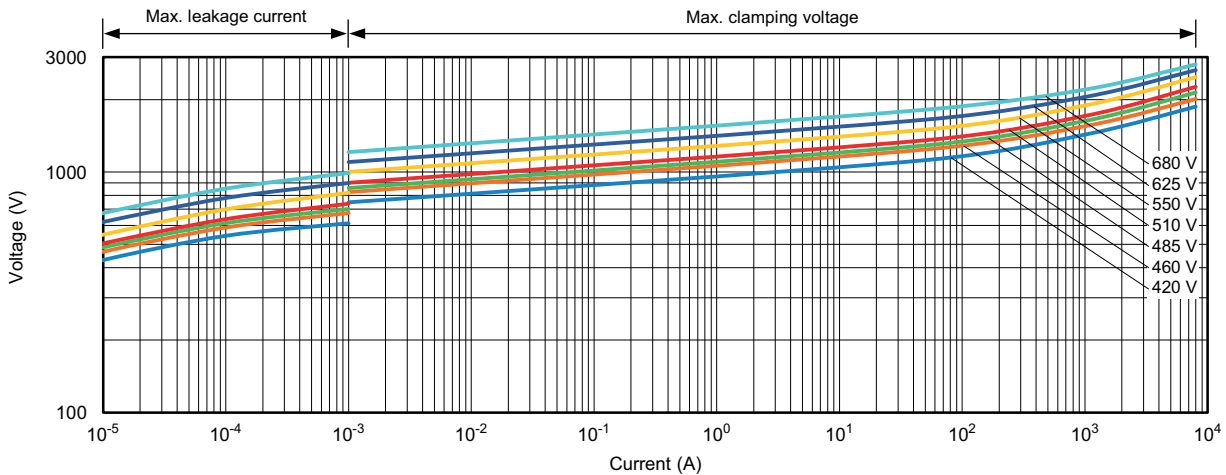

420 V<sub>RMS</sub> to 680 V<sub>RMS</sub>; VDRUS14



## V/I CHARACTERISTICS

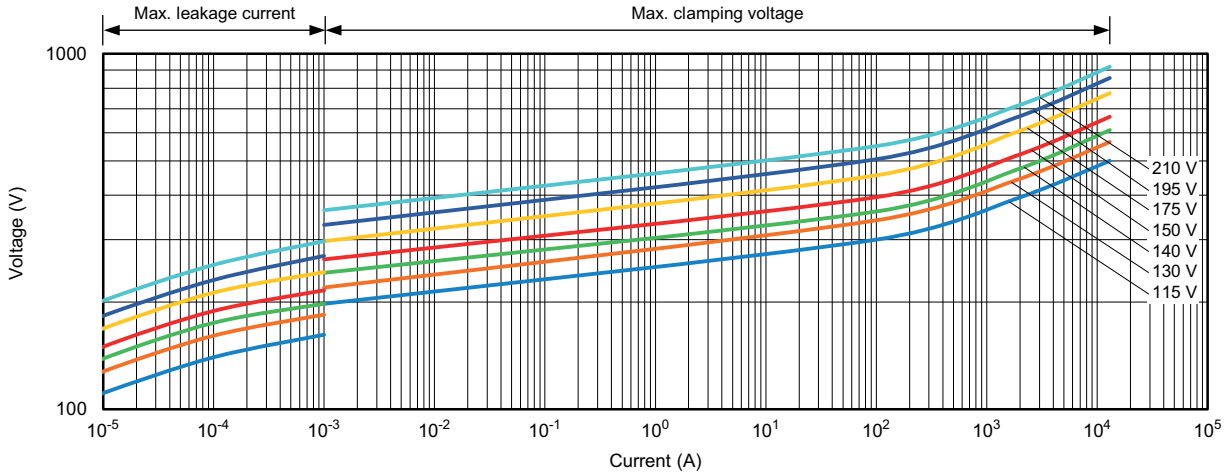

115 V<sub>RMS</sub> to 210 V<sub>RMS</sub>; VDRUS20

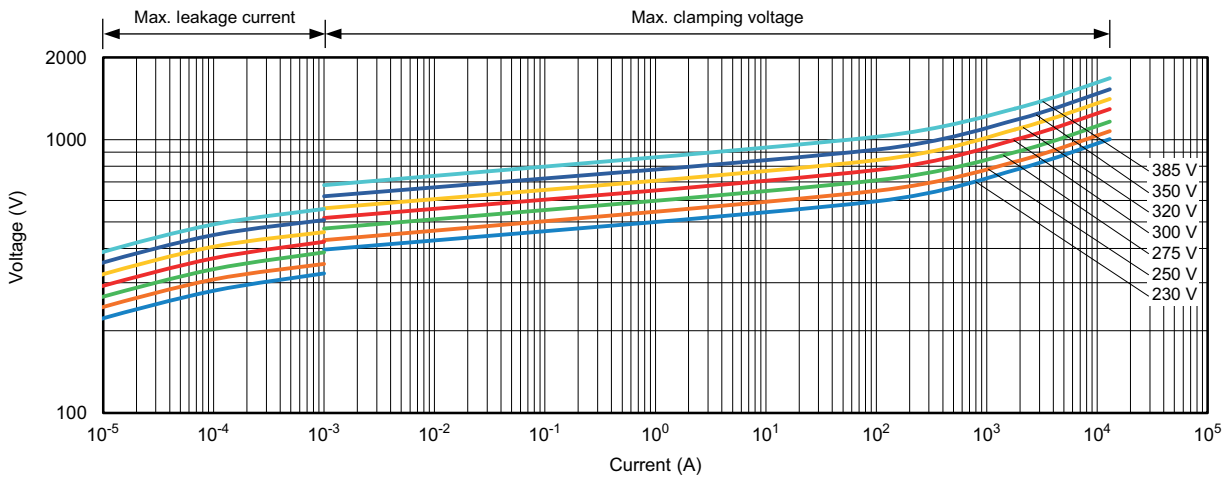

230 V<sub>RMS</sub> to 385 V<sub>RMS</sub>; VDRUS20

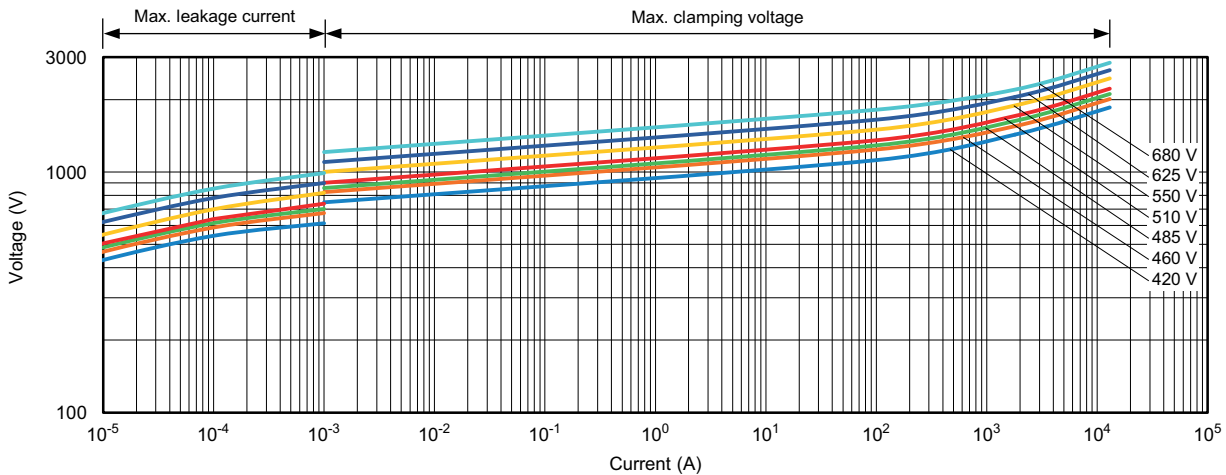

420 V<sub>RMS</sub> to 680 V<sub>RMS</sub>; VDRUS20



PULSE DERATING

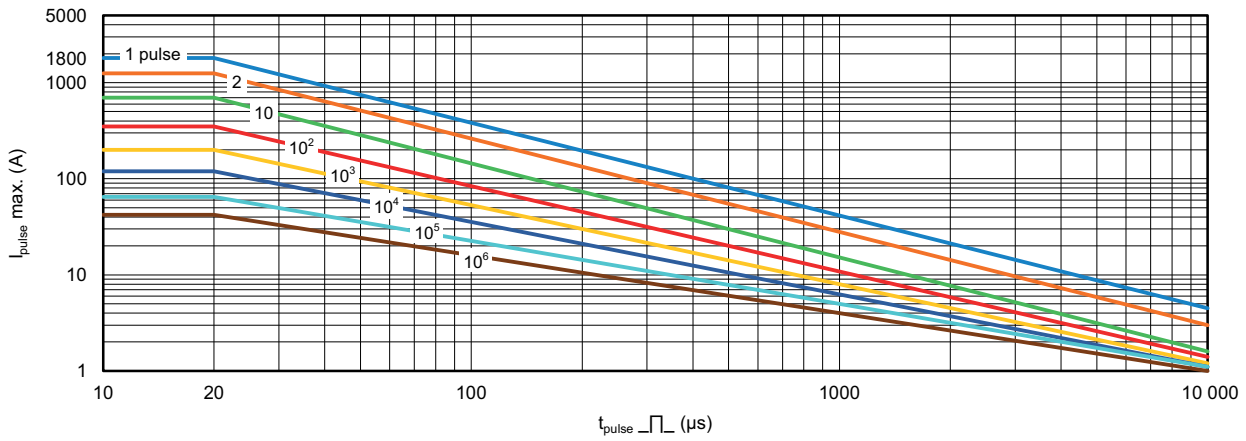

115 V<sub>RMS</sub> to 510 V<sub>RMS</sub>; VDRUS07

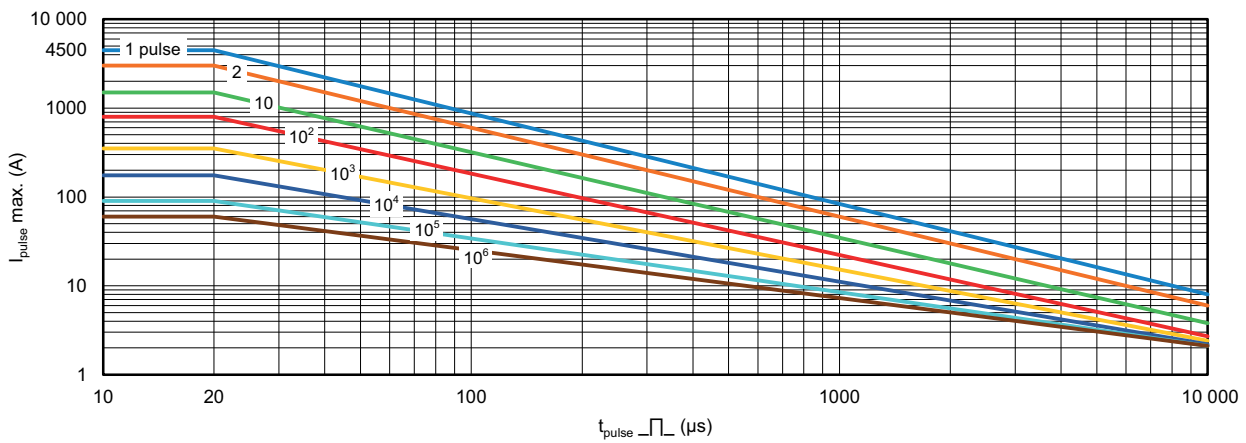

115 V<sub>RMS</sub> to 680 V<sub>RMS</sub>; VDRUS10

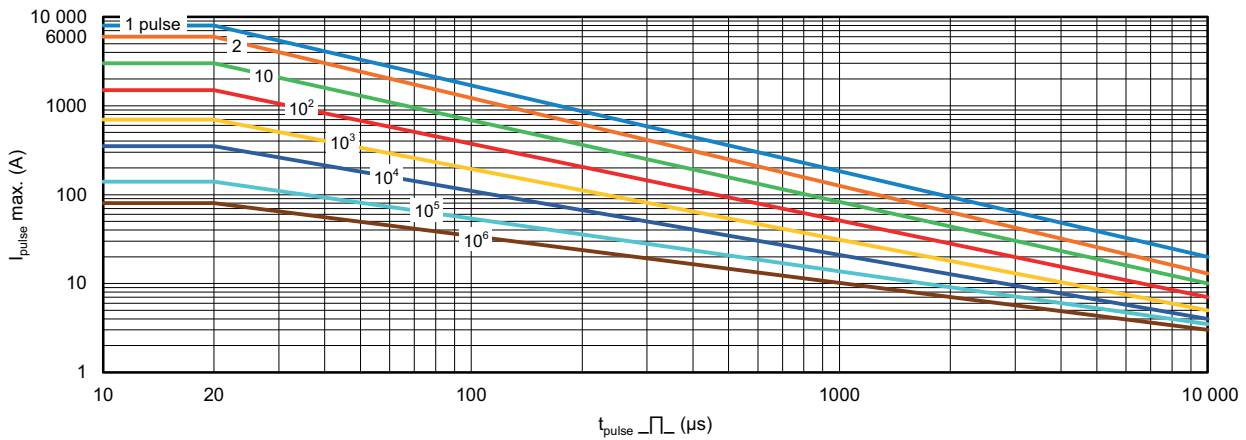

115 V<sub>RMS</sub> to 680 V<sub>RMS</sub>; VDRUS14



## PULSE DERATING

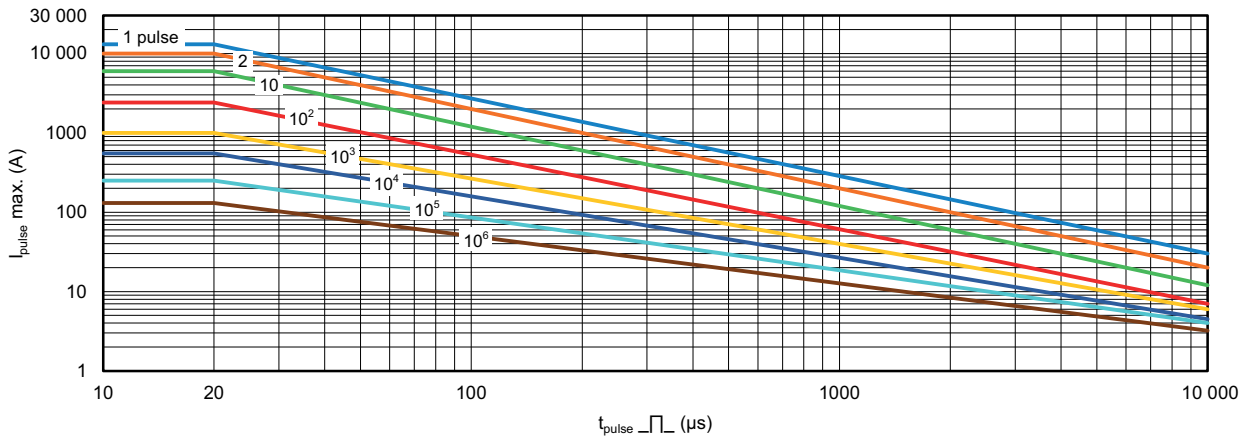

115  $V_{RMS}$  to 680  $V_{RMS}$ ; VDRUS20



## **Disclaimer**

ALL PRODUCT, PRODUCT SPECIFICATIONS AND DATA ARE SUBJECT TO CHANGE WITHOUT NOTICE TO IMPROVE RELIABILITY, FUNCTION OR DESIGN OR OTHERWISE.

Vishay Intertechnology, Inc., its affiliates, agents, and employees, and all persons acting on its or their behalf (collectively, "Vishay"), disclaim any and all liability for any errors, inaccuracies or incompleteness contained in any datasheet or in any other disclosure relating to any product.

Vishay makes no warranty, representation or guarantee regarding the suitability of the products for any particular purpose or the continuing production of any product. To the maximum extent permitted by applicable law, Vishay disclaims (i) any and all liability arising out of the application or use of any product, (ii) any and all liability, including without limitation special, consequential or incidental damages, and (iii) any and all implied warranties, including warranties of fitness for particular purpose, non-infringement and merchantability.

Statements regarding the suitability of products for certain types of applications are based on Vishay's knowledge of typical requirements that are often placed on Vishay products in generic applications. Such statements are not binding statements about the suitability of products for a particular application. It is the customer's responsibility to validate that a particular product with the properties described in the product specification is suitable for use in a particular application. Parameters provided in datasheets and / or specifications may vary in different applications and performance may vary over time. All operating parameters, including typical parameters, must be validated for each customer application by the customer's technical experts. Product specifications do not expand or otherwise modify Vishay's terms and conditions of purchase, including but not limited to the warranty expressed therein.

Except as expressly indicated in writing, Vishay products are not designed for use in medical, life-saving, or life-sustaining applications or for any other application in which the failure of the Vishay product could result in personal injury or death. Customers using or selling Vishay products not expressly indicated for use in such applications do so at their own risk. Please contact authorized Vishay personnel to obtain written terms and conditions regarding products designed for such applications.

No license, express or implied, by estoppel or otherwise, to any intellectual property rights is granted by this document or by any conduct of Vishay. Product names and markings noted herein may be trademarks of their respective owners.