

# V-Series

## Contura X, XI, XII Switches

The V-Series Contura X, XI & XII snap-in rocker/paddle switches offer countless unique options including choices for ratings, circuits, colors, illuminations and symbols. These single or double pole switches feature removable actuators in a choice of actuator styles and colors, and can be illuminated with either square or bar shaped lenses. Actuators and square lenses may also be purchased and stocked separately from the base assembly. They also feature a raised bracket/bezel which helps prevent inadvertent actuation of the switch.

The Contura switches with sealed option, are certified to IP66 and IP68, signifying complete protection against dust and prolonged spray and submersion under pressure, and are recognized to UL1500 - Ignition Protection for Marine Products. These switches are vibration, shock, thermoshock, moisture and salt spray resistant. Temperature ratings range from -40°C to +85°C.

### Resources:

[Download 3D CAD Files](#)

[IGS >](#) [STP >](#)

[Watch Product Video](#)



Contura X



Contura XI



Contura XII

### Product Highlights:

- ♦ Countless options for ratings, circuits, colors, illuminations and legends
- ♦ Certified to IP66 and IP68 for front panel components
- ♦ Vibration, shock, thermoshock, moisture and salt spray resistant
- ♦ Temperature range from -40°C to +85°C.

### Typical Applications:

- ♦ On/Off Highway Equipment
- ♦ Marine
- ♦ Military Armored Vehicles
- ♦ Mining Machinery and Equipment
- ♦ Any application requiring environmental protection



**Carling Technologies™**

Innovative Designs. Powerful Solutions.

**Carling Technologies, Inc.**  
60 Johnson Avenue, Plainville, CT 06062  
Email: [sales@carlingtech.com](mailto:sales@carlingtech.com)  
Application Support: [team2@carlingtech.com](mailto:team2@carlingtech.com)  
Phone: (860) 793-9281 • Fax: (860) 793-9231  
[www.carlingtech.com](http://www.carlingtech.com)

# V-Series Switch

## DESIGN FEATURES

### INTERCHANGEABLE ACTUATORS

Panel redesign is a snap with our wide range of rocker/paddle styles. Achieve maximum design variety with minimum inventory. Simply swap rockers to create an entirely new look for your panel.

### DUAL SEAL PROTECTION

Seals out water, dust, debris, and enables switch certification to IP66/IP68 for front panel components.

### CLEAN CONNECTIONS

Options for both eight and ten terminal base styles with AMP & Packard compatible connectors affords myriad circuit options while providing ease of assembly.

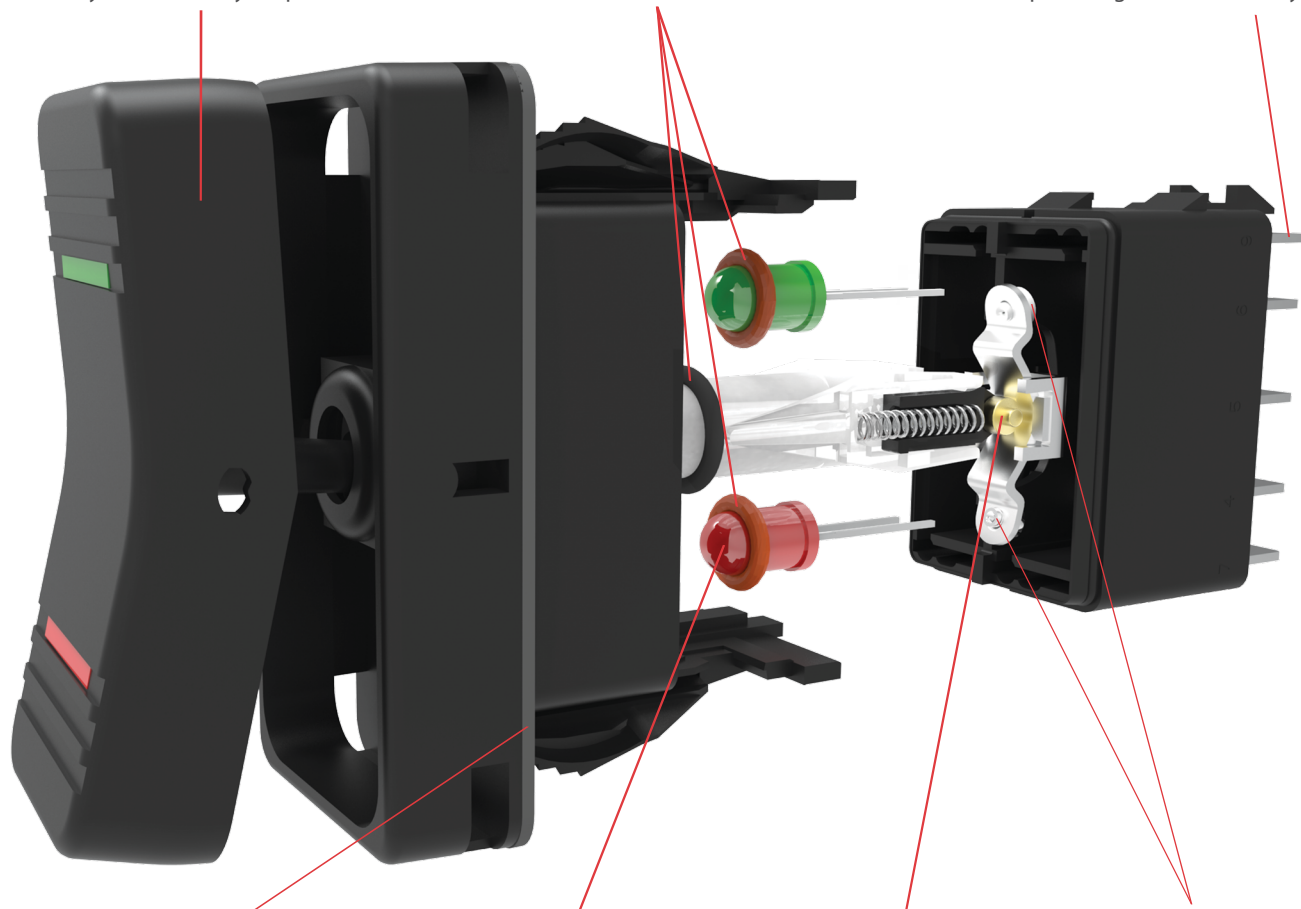

### OPTIONAL PANEL SEAL

Prevents water/dust ingress behind panel.

### MULTIPLE LIGHTING OPTIONS

In addition to incandescent lamps, our LED illumination is offered in a wide array of light intensities, colors, as well as dual level, tri-color, and flashing options.

### BRASS ROLLER PIN

Robust mechanism eliminates the need for lubricants. Enables switch to withstand -40°C to +85°C temperatures.

### SILVER PLATED BUTT CONTACT MECHANISM

Providing 50K to 100K electrical cycles and a variety of different electrical ratings.

## Electrical

Contact Rating	.4VA @ 24VDC (MAX) resistive 15 amps, 125VAC 10 amps, 250VAC 1/2 HP 125-250VAC 20 amps, 4-14VDC 15 amps, 15-28VDC 10A, 14VT 6A, 125VAC L
Dielectric Strength	1500 Volts RMS
Insulation Resistance	50 Megohms
Initial Contact Resistance	10 milliohms max. @ 4VDC
Life	50,000- 100,000 cycles circuit dependent
Contacts	Silver alloy, silver tin-oxide, fine silver
Terminals	Brass or copper/silver plate 1/4" (6.3mm) Quick Connect terminations standard. Solder lug, Wire Lead

## Mechanical

Endurance	150,000 cycles minimum circuit dependent
-----------	--

## Physical

Lighted	Incandescent - rated 10,000 hours Neon - rated 25,000 hours LED - rated 100,000 hours 1/2 life (LED is internally ballasted for voltages to 24VDC)
Seals	Internal Optional external gasket panel seal
Base	Polyester blend rated to 125°C with a UL flammability rating of 94V0.
Contura II,III,IV,V, VI, VII Actuator	<b>Hard Surface:</b> Basic actuator structure molded of thermoplastic polycarbonate with a hard Nylon 66 thermoplastic surface overlay. <b>Soft Surface:</b> Basic actuator structure molded of thermoplastic polycarbonate with an elastomer overlay.
Contura X,XI,XII Actuator,VP	Nylon 66 Reinforced rated to 105°C
Lens	Polycarbonate rated at 100°C
Contura XIV	Polycarbonate lens/subrocker with ABS shell

## Actuator Travel (Angular Displacement)

2 position	18°
3 positions	9° from center

## Mounting Specifications

Panel Thickness Range

**Gaskets Acceptable Panel Thickness**

0	.030 to .250 (.76mm to 6.35mm)
1	.030 to .109 & .147 to .157 (.76 to 2.77mm & 3.73 to 3.98mm)

Recommended: No gasket with panel thickness of .032, .062, .093, .125, .187 or .250

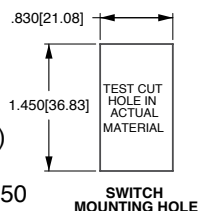

## Agency Certifications



## Environmental

Sealing	Sealed version: IP68, in accordance with IEC 60529, BS 5490, DIN 40050 & NFC 20 010. This rating applies to front panel components of the actual switch only, and signifies protection against dust and the prolonged effects of immersion under pressure. The standard test for immersion under pressure requires submersion under one meter of water for 30 min. The V-Series switch has exceeded these parameters, having been actuated and illuminated during submersion.
Corrosion	Mixed Flowing Gas (MFG) Class III 3 year accelerated exposure per ASTM B-827, B-845 Silver and gold contacts
Operating Temp.	-40°C to +85°C
Vibration 1	Per Mil-Std 202F, Method 204D Test Condition A 0.06 DA or 10G's 10-500 Hz. Tested with VCH connector. Test criteria - No loss of circuit during test, pre and post test contact resistance.
Vibration 2	Resonance search 24-50 Hz 0.40 DA 50-2000 Hz ±10 G's peak Horizontal Axis 3-5 G's max. Random 24 Hz 0.06 PSD-Gsq/Hz 60 Hz 0.50 100 Hz 0.50 200 Hz 0.025 2000 Hz 0.025 No loss of circuit during test; <10µ seconds chatter.
Shock	Per Mil-Std 202F, Method 213B, Test Condition K @ 30G's. Tested with VCH connector. Test criteria - No loss of circuit during test, pre and post test contact resistance.
Salt Spray	Per Mil-Std 202F, Method 101D, Test Condition A, 96 Hrs. Sealed version only.
Dust	Per Mil-Std 810C, Method 510.2 Air Velocity 300 ±200 Feet/Min, Test Duration 16 Hrs.
Thermal Shock	Per Mil-Std 202F, Method 107F, Test Cond. A, -55°C to +85°C. Test criteria - pre and post test contact resistance
Moisture Resistance	Per Mil-Std 202F, Method 106F, Test Criteria - pre and post test contact resistance
Ignition Protection	All Contura switches with sealed construction meet the requirements of UL1500/ISO8846 for ignition protection, in addition to conformance with EC directive 94/25/EC for marine products.

## Dimensional Specifications: in. [mm]

**CONTURA X**  
SHOWN WITH RAISED BRACKET

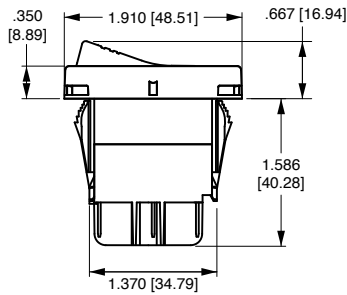
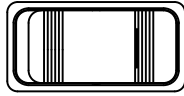

**8 TERMINAL BASE  
W/BARRIERS**

**CONTURA XI**  
SHOWN WITH RAISED  
BRACKET AND TWO SQUARE  
LENSES

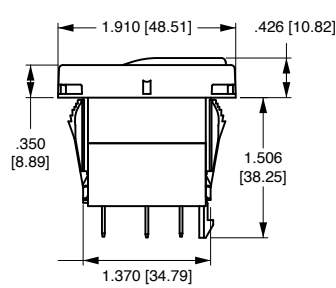
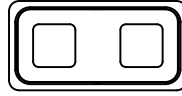

**10 TERMINAL BASE  
W/O BARRIERS**

**CONTURA XII**  
SHOWN WITH PADDLE  
ACTUATOR

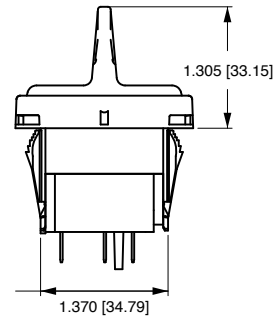
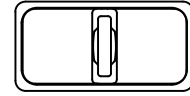

**8 TERMINAL BASE  
W/O BARRIERS**

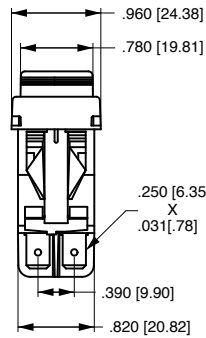

**8 TERMINAL BASE  
W/BARRIERS**

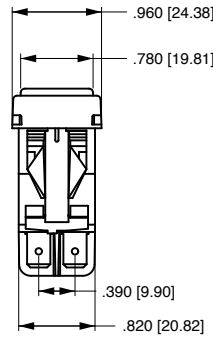

**10 TERMINAL BASE  
W/BARRIERS**

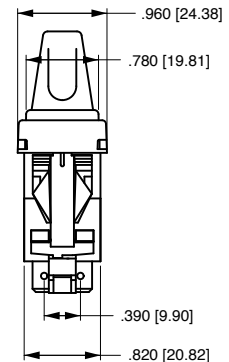

**10 TERMINAL  
BASE  
W/O BARRIERS**

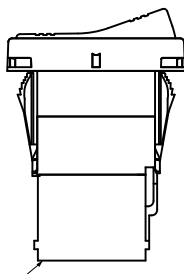

SWITCH SHOWN WITH  
VCH CONNECTOR  
8 TERMINAL

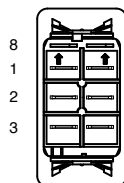

**BOTTOM VIEW  
TERMINAL  
ARRANGEMENT  
8 TERMINAL BASE**

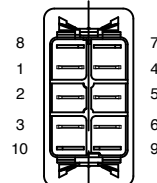

**BOTTOM VIEW  
TERMINAL  
ARRANGEMENT  
10 TERMINAL BASE**

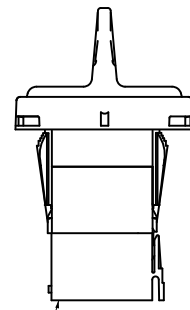

SWITCHES SHOWN WITH  
VC1 CONNECTOR  
10 TERMINAL

CIRCUIT	CIRCUIT DIAGRAM
1	
2	
3	
4	
5	
6	
7	
8	

CIRCUIT	CIRCUIT DIAGRAM
A	
B	
C	
D	
E	
F	
G	
H	

CIRCUIT	CIRCUIT DIAGRAM
J	
K	
L	
M	
R	
S	

SYMBOL LEGEND	
SYM.	DEFINITION
	DESIGNATES TERMINALS AND CONTACTS
	DESIGNATES LAMP LOCATION
	DESIGNATES MAINTAINED CIRCUITS
	DESIGNATES OTHER POSITION
	DESIGNATES MOMENTARY CIRCUITS
	DESIGNATES TWO POSITION CONNECTION
	DESIGNATES EXTERNAL JUMPER PROVIDED BY CUSTOMER

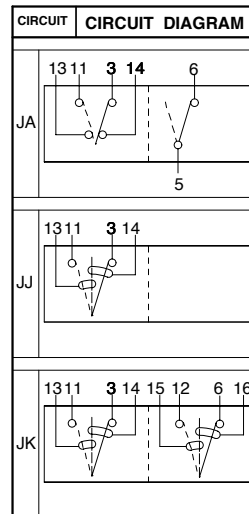
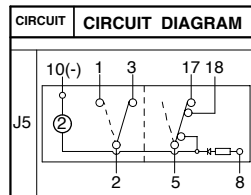
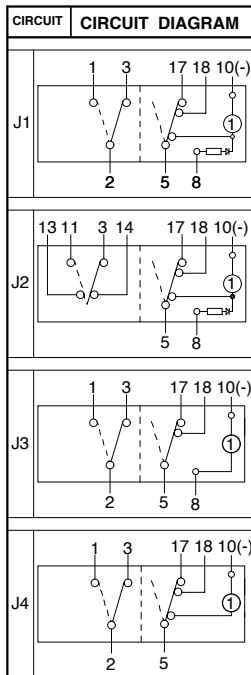
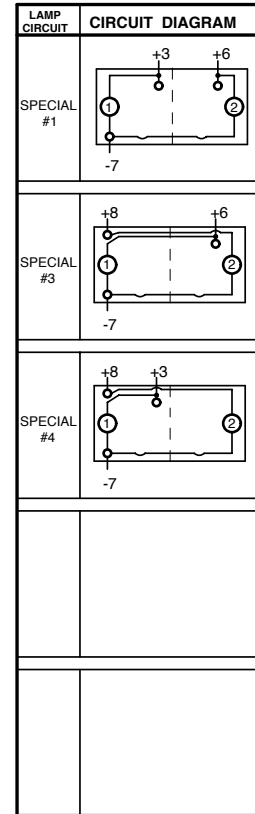
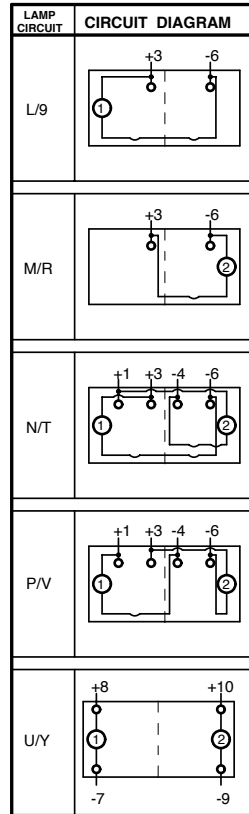
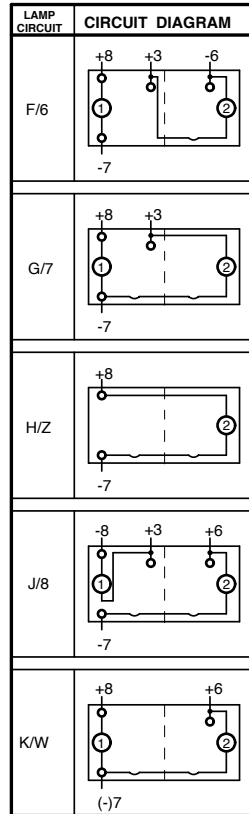
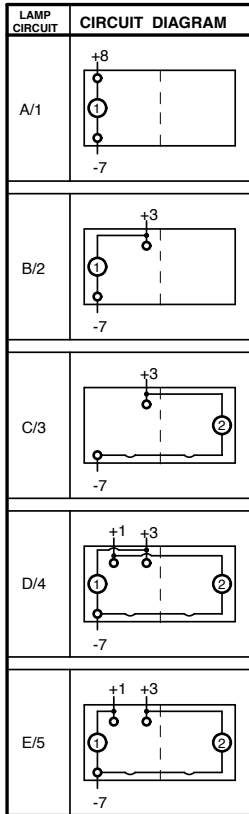

NOTE:  
J circuits are available for all non-locking V-Series styles. Consult factory for p/n details.

SYMBOL LEGEND	
SYM.	DEFINITION
○	DESIGNATES TERMINALS AND CONTACTS
○	DESIGNATES LAMP LOCATION
○	DESIGNATES TWO POSITION CIRCUIT

CIRCUIT	CONNECTOR PART #
JA, JJ, JK	JC1-01
J1, J3, J4, J5	JC2-01
J2	JC3-01

**V 1 D A B 6 0 1 - 6 P Z 00 - 0 00**

1 Series    2 Circuit    3 Rating    4 Termination    5 Illumination    6 Lamp    7 Lamp    8 Bracket    9 Actuator    10 Lens    11 Lens    12 Legend    13 Legend    14 Actuator  
Orientation    Lens Legend

**1 SERIES**  
**V**

**2 CIRCUIT**  
Terminal Connections as viewed from bottom of switch:  
8 terminal    10 terminal  
8 - -7    8 - -7  
1 - -4    1 - -4  
2 - -5    2 - -5  
3 - -6    3 - -6  
10 - -9

( ) - momentary  
SP - single pole - uses terminals 1, 2 & 3.  
DP - double pole uses terminals 1, 2, 3, 4, 5 & 6.  
Terminals 7, 8, 9 & 10 for lamp circuit only.

**Position:**

SP DP:	1	2	3
1 A	ON	NONE	OFF
2 B	(ON)	NONE	OFF
3 C	ON	NONE	(OFF)
4 D	ON	NONE	ON
5 F	ON	NONE	(ON)
6 J	ON	OFF	ON
7 K	ON	OFF	(ON)
8 L	(ON)	OFF	(ON)

**SPECIAL CIRCUITS**

	2 & 3	2 & 3, 5 & 6	5 & 4
H*	2 & 3	2 & 3	5 & 4
G*	2 & 3, 5 & 6	2 & 3	OFF
S*	2 & 3, 5 & 6	2 & 3	1 & 2
M*	(2 & 3, 5 & 6)	2 & 3	OFF
R*	(2 & 3, 5 & 6)	2 & 3	2 & 1
E*	5 & 6	5 & 3	5 & 1

\*Jumper between terminals 2 & 5 for circuits H, G, M, R & S are specified in selection 4. External jumper between terminals 2 & 4 for circuit E are provided by customer. Circuit E may be used for SP OFF-ON-ON circuit.

**3 RATING<sup>4</sup>**

1	4VA @ 28VDC Resistive
B	15A 24V
C	20A 18V
D	20A 12V
E	20A 14V, 10A 14VT (circuit 1, 4, A & D only)
F	10A 14V, 6A 14VT (circuit G only)
M	.4VA/20A 12V
N	.4VA/15A 24V

**4 TERMINATION/BASE STYLE**

8 term	10 Term	Termination	Jumper
1	2	.250 TAB (QC) no barriers	No
A	B	.250 TAB (QC) with barriers	No
J	K	.250 TAB (QC) no barriers	Yes T2 to 5
3	5	Solder Lug no barriers	No
C	D	Solder Lug	No
5	6	Wire Leads no barriers	No
E	F	Wire Leads	No

Note: Codes J & K for circuits H, G & M.

**5 ILLUMINATION & SWITCH SEALING**  
Lamp #1 above terminals 1 & 4 end of switch.; Lamp #2 above terminals 3 & 6 end of switch. Positive (+) and negative (-) symbols apply to LED lamps only

Sealed	Unsealed	Lamps	Illumination Type	Lamp wired to Terminals
S	0	NONE	-	-
A	1	1	INDEPENDENT	8 (+) 7 (-)
B	2	1	DOWN	3 (+) 7 (-)
C	3	2	UP	3 (+) 7 (-)
D	4	1	DOWN	3 (+) 7 (-)
E	5	1	UP	1 (+) 7 (-)
F	6	2	UP	3 (+) 7 (-)
F	6	1	INDEPENDENT	8 (+) 7 (-)
G	7	1	INDEPENDENT	8 (+) 7 (-)
H	Z	2	UP	3 (+) 7 (-)
H	Z	2	INDEPENDENT	8 (+) 7 (-)
U	Y	2	INDEPENDENT	8 (+) 7 (-)
U	Y	1	INDEPENDENT	10 (+) 9 (-)

**SINGLE POLE SWITCHES ONLY**

J	8	1	DOWN	3 (+) 8 (-)
J	8	2	INDEPENDENT	6 (+) 7 (-)
K	W	1	INDEPENDENT	8 (+) 7 (-)
K	W	2	INDEPENDENT	6 (+) 7 (-)

**DOUBLE POLE SWITCHES ONLY**

L	9	1	DOWN	3 (+) 6 (-)
M	R	1	UP	3 (+) 6 (-)
N	T	1	DOWN	3 (+) 6 (-)
N	T	2	DOWN	1 (+) 4 (-)
P	V	1	UP	1 (+) 4 (-)
P	V	2	UP	3 (+) 6 (-)

Notes:  
Consult factory to verify horsepower rating for your particular circuit choice.  
1 Custom colors are available. Consult factory.  
2 White imprinting is standard on black actuators; Black imprinting is standard on white, red & gray actuators. Custom colors are available, consult factory.  
3 With 2 square lenses, use sel. 12 for lens above lamp 1, & selection 14 for lens above lamp 2.  
4 Additional ratings available. See V-Series Switch Accessories page.  
5 Not available with Contura XI rockers.

**6,7 LAMP (same coding for both selections)**  
Selection 6: above terminals 1 & 4; Selection 7: above terminals 3 & 6

No lamp	0	2 250VAC	6 12V superbright	7 18V superbright	8 24V superbright
Neon	1 125VAC	5 6V	Green	Red	
Incandescent	4 3V				
LED*					
2VDC	A Red	L Amber	F superbright	R superbright	
6VDC	B	M	G Green	S Red	
12VDC	C	N	H	T	
24VDC	D	P	J	V	

\* Consult factory for "daylight bright" LED options. Typical current draw for LED is 20ma.

**8 BRACKET COLOR<sup>1</sup>, PANEL SEAL (EXTERNAL FOAM GASKET)**

	X & XI w/Flush Bracket	X, XI, XII w/Raised Bracket
# of gaskets	0	1
Black	B	D
White	W	Z
Gray	G	J

**9 ACTUATOR**

No Actuator	0	Black	Gray	White	Red
Contura X	1	2	3	4	
Contura XI	6	7	8	9	
Contura XII	J	K	N	M	

Actuator orientation above terminals:  
3,6    1,4

**10 LENS - ABOVE LAMP #1 TERMINALS<sup>1,4</sup>**  
**11 LENS - ABOVE LAMP #2 TERMINALS<sup>3,6</sup>**

0 - No Actuator	Z - No Lens	Lens Style				
Clear	White	Amber	Green	Red	Blue	Bar
3	8	D	J	P	V	One piece Square
4	9	E	K	R	W	Two piece Square*
5	A	F	L	S	Y	(w/ clear top protective lens)
2	7	C	H	N	U	Two piece Square*
1	6	B	G	M	T	(w/ smoke top protective lens)
						Two piece Square*
						(w/ white top protective lens)

\* All bottom lenses are molded of opaque material. Consult factory for other lens colors. Lens color for LEDs must be clear, white, or match color of LED. Green or blue lenses are not recommended with Neon lamps.

**12 ACTUATOR LENS OR BODY LEGEND<sup>2</sup>**

00 - No Legend this location/No actuator

11 ON	12 OFF	13 I	14 O
OFF	ON	O	I

15 O O	16 O O	17 O I	18 I O
F N	N F	F	

21 OFF	22 ON	23 O	24 I
F	N		

25 O	26 O	27 O	28 I
F	N		

For additional legend options & codes, visit us at [www.carlingtech.com](http://www.carlingtech.com).

**13 LEGEND ORIENTATION<sup>3</sup>**

0 No legend (used with codes 11-18 in selection 12)

1 Orientation 1

2 Orientation 2

3 Orientation 3

4 Orientation 4

**14 ACTUATOR LENS LEGEND**

00 No legend this location / no actuator (used with codes 11-18 in selection 12) Selection 14 required when switch requires two legends. If the two legends consist of one lens and one body legend, lens legend must be specified in selection 12; body legend specified in selection 14. For legend options & codes, visit us at [www.carlingtech.com](http://www.carlingtech.com).



**V 1 D A S W 0 1 - 1 P B 00 - 0**

1 Series    2 Circuit    3 Rating    4 Termination    5 Illumination    6 Lock    7 Lamp    8 Bracket    9 Actuator    10 Lens    11 Function    12 Legend    13 Legend Orientation

**1 SERIES**  
V

**2 CIRCUIT**

Terminal Connections as viewed from bottom of switch:

8 terminal	10 terminal	( ) - momentary	SP - single pole - uses terminals 1, 2 & 3.
8 - -7	8 - -7	DP - double pole uses terminals 1, 2, 3, 4, 5 & 6.	Terminals 7, 8, 9 & 10 for lamp circuit only.
1 - -4	1 - -4		
2 - -5	2 - -5		
3 - -6	3 - -6		
	10 - -9		

**Position:**

SP	DP	2 & 3, 5 & 6	Connected Terminals	1 & 2, 4 & 5
1 A		ON	NONE	OFF
4 D		ON	NONE	ON
6 J		ON	OFF	ON
9 N		OFF	NONE	ON

**SPECIAL CIRCUITS**

H*	2 & 3	2 & 3, 5 & 4	5 & 4
G*	2 & 3, 5 & 6	2 & 3	OFF
S*	2 & 3, 5 & 6	2 & 3	1 & 2
E*	5 & 6	5 & 3	5 & 1

\*Jumper between terminals 2 & 5 for circuits H, G, M, R & S are specified in selection 4. External jumper between terminals 2 & 4 for circuit E are provided by customer. Circuit E may be used for SP OFF-ON-ON circuit.

**3 RATING<sup>4</sup>**

1 .4VA @ 28VDC Resistive  
 B 15A 24V  
 C 20A 18V  
 D 20A 12V  
 E 20A 14V, 10A 14VT (circuit 1, 4, A & D only)  
 F 10A 14V, 6A 14VT (circuit G only)  
 M .4VA/20A 12V  
 N .4VA/15A 24V

**4 TERMINATION/BASE STYLE**

8 Term	10 Term	Termination	Jumper
1	2	.250 TAB (QC) no barriers	No
A	B	.250 TAB (QC) with barriers	No
J	K	.250 TAB (QC) no barriers	Yes T2 to 5
3	5	Solder Lug no barriers	No
C	D	Solder Lug	No
5	6	Wire Leads no barriers	No
E	F	Wire Leads	No

Note: Codes J & K for circuits H, G & M.

**5 ILLUMINATION & SWITCH SEALING**

Lamp #1: above terminals 1 & 4 end of switch.; Lamp #2 above terminals 3 & 6 end of switch. Positive (+) and negative (-) symbols apply to LED lamps only

Sealed	Unsealed	Lamps	Illumination Type	Lamp wired to Terminals
S	0	NONE	-	-
C	3	2	UP	3 (+) 7 (-)
H	Z	2	INDEPENDENT	8 (+) 7 (-)

**DOUBLE POLE SWITCHES ONLY**

M	R	1	UP	3 (+) 6 (-)
---	---	---	----	-------------

**6 LOCK**

Lock above terminals 1 & 4 end of switch.  
 W lock

Notes:  
 Consult factory to verify horsepower rating for your particular circuit choice.  
 1 Custom colors are available. Consult factory.  
 2 White imprinting is standard on black actuators; Black imprinting is standard on white, red and gray actuators; Custom colors are available, consult factory.  
 3 Located over T1-4 end of switch.  
 4 Additional ratings available. See V-Series Switch Accessories page.  
 5 Located over T3-6 end of switch.

**6,7 LAMP (same coding for both selections)**

Selection 6: above terminals 1 & 4; Selection 7: above terminals 3 & 6

No lamp	0	2 250VAC	6 12V superbright	7 18V superbright	8 24V superbright
Neon	1 125VAC	5 6V	Green	Red	
Incandescent LED*	4 3V		F	R	
	Red	Amber	G	S	
2VDC	A	L	H	T	
6VDC	B	M	J	V	
12VDC	C	N			
24VDC	D	P			

\* Consult factory for "daylight bright" LED options. Typical current draw for LED is 20ma.

**8 FLUSH BRACKET COLOR<sup>1</sup>, PANEL SEAL**

	Black	White	Gray
No Gasket	1	2	3
One Gasket	4	5	6

**9 HARD SURFACE ACTUATOR**

Contura X	Black	Grey	Red	White
	1	2	3	4

Actuator orientation above terminals: 3,6    1,4

**10 LENS - ABOVE LAMP #2 TERMINALS<sup>5</sup>**

Z - No Lens

Clear	White	Amber	Green	Red	Blue	Lens Style
3	8	D	J	P	V	Bar
4	9	E	K	R	W	One piece Square
5	A	F	L	S	Y	Two piece Square*
						(w/ clear top protective lens)
2	7	C	H	N	U	Two piece Square*
						(w/ smoke top protective lens)
1	6	B	G	M	T	Two piece Square*
						(w/ white top protective lens)

\* All bottom lenses are molded of opaque material. Consult factory for other lens colors. Lens color for LEDs must be clear, white, or match color of LED. Green or blue lenses are not recommended with Neon lamps.

**11 ACTUATOR LOCK FUNCTION AND COLOR<sup>3</sup>**

Lock Color	Up	Down	Up & Down
Match Actuator	A	H	R
Black	B	J	S
White	C	K	T
Red	D	L	V
Gray	E	M	W
Safety Orange	F	N	Y

**12 ACTUATOR LENS OR BODY LEGEND<sup>2</sup>**

00 - No Legend

21	22	23	24
OFF	ON	O	I
25	26	27	28
F	N	O	I
F			

For additional legend options & codes, visit us at [www.carlingtech.com](http://www.carlingtech.com).

**13 LEGEND ORIENTATION<sup>3</sup>**

0 No legend (used with codes 11-18 in selection 12)

1 Orientation 1

2 Orientation 2

3 Orientation 3

4 Orientation 4



Easily integrate Contura products into your system, with Contura Accessories

Contura Connectors

Q.C. SELECTION GUIDE					
COMPANY SERIES	PART NO		WIRE RANGE		ORIENTATION
	PLAIN BRASS	TIN PLATED BRASS	AWG	MM <sup>2</sup> (REF)	
PACKARD 58 SERIES	02965580		12	3.0	B
	02965471	12010601	(2)16-14	(2)1.0-2.0	
	02965470		16-14	1.0-2.0	
	02965469	06288318	20-18	.5-.8	
PACKARD METRI-PACK 630 SERIES		12084590	10	5.0	A
		12052224	12	3.0	
		12015870	16-14	1.0-2.0	
		12020035	(2)22-18	(2).5-.8	
		12015832	20-18	.5-.8	
AMP 250 SERIES FASTIN-FASTON	60253-1	60253-2	16-12	1.3-3	B
	42100-1	42100-2	(2) 16	(2) 1.3	
			18-14	.8-2	
	60295-1	60295-2	22-18	.3-.9	

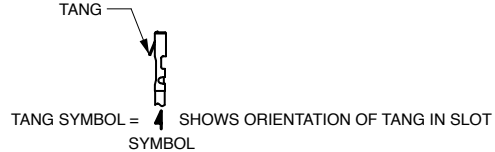
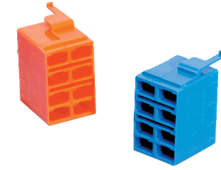

NOTE: Consult Delphi Packard and/or Amp on actual part numbers and availability. AMP is a registered trademark of AMP Inc. Harrisburg, PA. Delphi Packard is a registered trademark of Delphi-Packard Electrical Systems Warren, Ohio

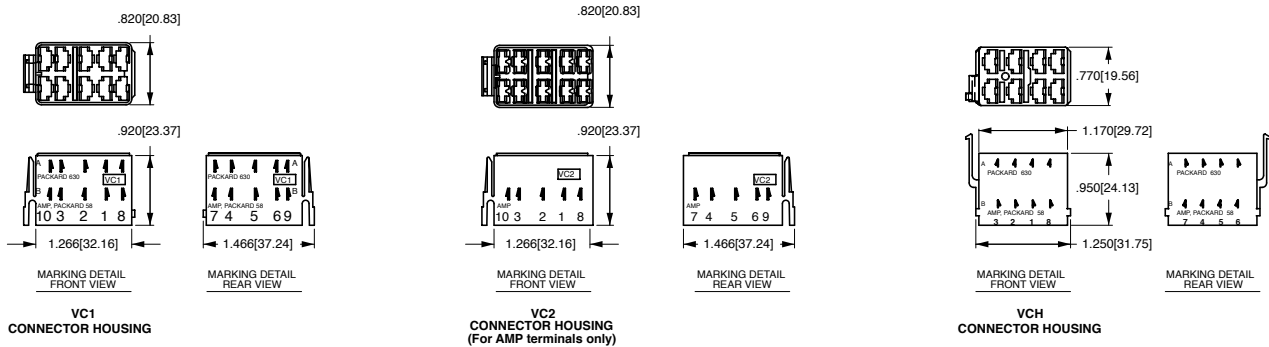

Contura X Boot (P/N VB1-01)

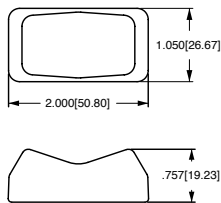

Contura II, III, IV & V Actuator Removal Tool (P/N VRT)

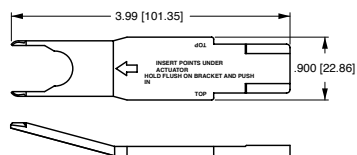

Additional V-Series Ratings

- 1 .4VA @ 28VDC Resistive
- 4 10A 250VAC 1/2 HP, 15A 125 VAC 1/2 HP, No Agency Listings
- 5<sup>1</sup> 10A 250VAC 1/2 HP, 15A 125 VAC 1/2 HP, UL Recognized, CSA Certified
- 6<sup>2</sup> 15A 125VAC 1/2 HP, 12(2)A 125 VAC μ T85
- 7<sup>2</sup> 15A 125VAC 1/2 HP, 12(6)A 125 VAC T85
- 8<sup>2</sup> 10A 250VAC, 15A 125VAC, 1/2 HP 125-250VAC, 12(2)A 250 VAC μ T85
- 9<sup>2</sup> 10A 250VAC, 15A 125VAC, 1/2 HP 125-250VAC, 12(6)A 250 VAC T85
- B 15A 24V
- C 20A 18V
- D 20A 12V
- E 20A 14V, 10A 14VT (circuits 1, 4, A, & D only)
- F 10A 14V, 6A, 14VT (circuit G only)
- G 20A 6V
- H 20A 3V
- L 15A 125 VAC, 10A 250VAC, 1/2 HP 125-250 VAC; 6A 125 VAC L
- M .4VA/20A 12V (combi-contact)  
(combination gold/silver contacts for borderline dry circuit applications)
- N .4VA/15A 24V (combi-contact)  
(combination gold/silver contacts for borderline dry circuit applications)

NOTES

- Consult factory to determine availability for individual circuits and their HP rating.
- Not available with Contura 7 or 14 rocker styles.
  - Ratings 6 - 9 are UL, CSA & VDE certified, require terminations A or B for double pole circuits, & are not available with illumination circuits 4, 8, D, J, N, & T or with wire lead or solder lug terminations.
- Circuits 1, 4, A, D, H, M & E are not available with rating 6 & 8. Rating 7 & 9 only available with circuits 1, 4, A & D. Circuits 2, 3, 5, 7, 8, K, L are 1/2 HP 250VAC only with rating 8. Ratings 6 & 7 must specify lamp code 1 (125VAC neon). Ratings 8 & 9 must specify lamp code 2 (250VAC neon). Rating L available with circuits 1, 4, A & D only.

## Contura Mounting Panels Dimensional Specifications: in. [mm]

**MOUNTING PANEL**  
For additional units, add 1.03[26.2] per unit.  
For more than 2 V-Series Switches, add  
middle section. Available in Panel Thicknesses  
listed below. Consult factory.

MOUNTING PANEL THICKNESS	
.062[1.57]	.187[4.75]
.093[2.36]	.250[6.35]
.125[3.17]	.375[9.52]

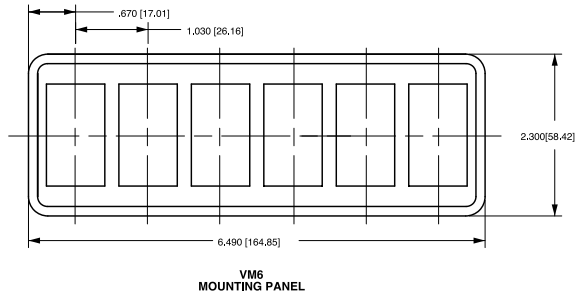
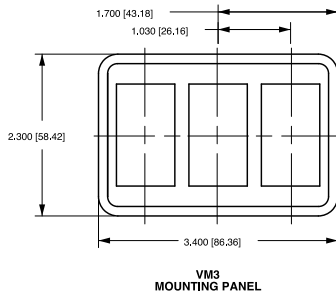
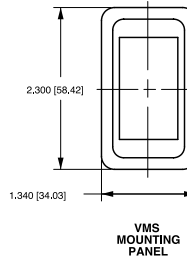
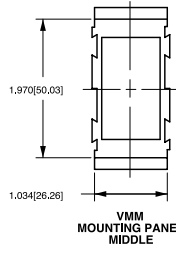
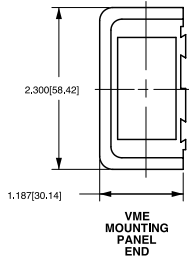
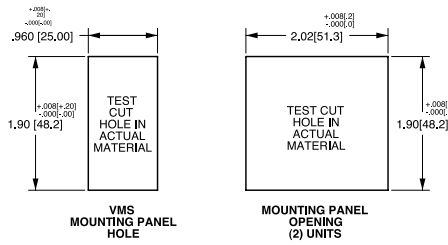

## Contura Hole Plug Dimensional Specifications: in. [mm]

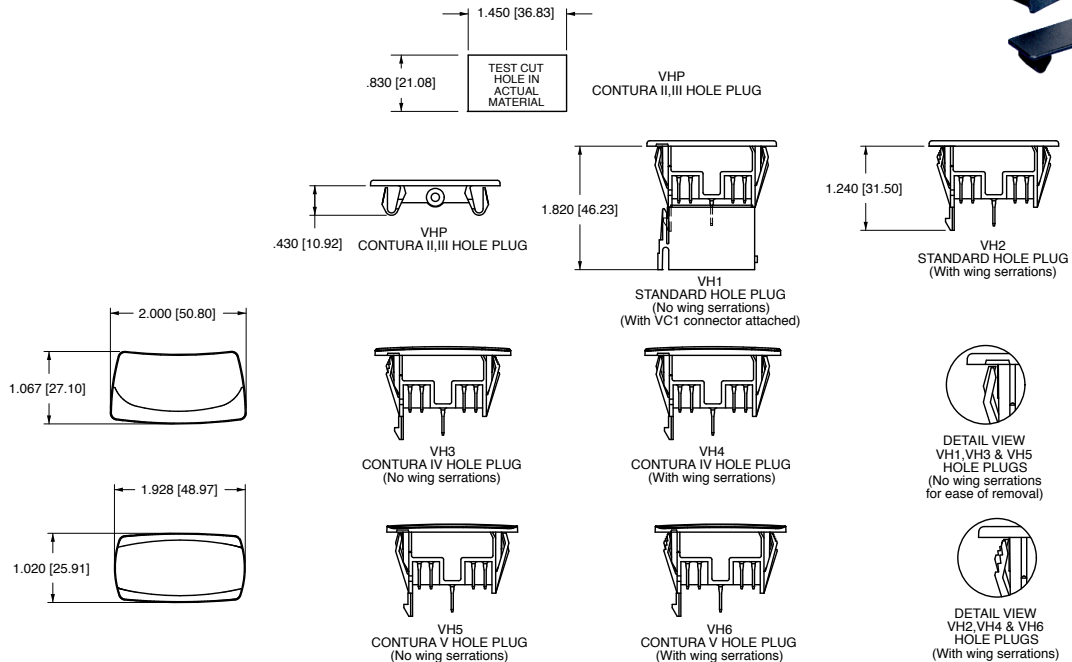

## Authorized North America Sales Representatives

Carling extensive sales representative network group is strategically located and ready to answer any questions. Find your local representative by clicking on a group name on the map below or by visiting [www.carlingtech.com/findarep](http://www.carlingtech.com/findarep).



## About Carling

Founded in 1920, Carling Technologies is a leading manufacturer of electrical and electronic switches and assemblies, circuit breakers, electronic controls, power distribution units, and multiplexed power distribution systems. With four ISO registered manufacturing facilities and technical sales offices worldwide, Carling Technologies Sales, Service and Engineering teams do much more than manufacture electrical components, they engineer powerful solutions! To learn more about Carling please visit [www.carlingtech.com/company-profile](http://www.carlingtech.com/company-profile).

### **Worldwide Headquarters**

Carling Technologies, Inc.  
60 Johnson Avenue • Plainville, CT 06062  
Phone: (860) 793-9281 • Fax: (860) 793-9231  
Email: sales@carlingtech.com • www.carlingtech.com

East Region Sales Office, CT • ersm@carlingtech.com  
Midwest Region Sales Office, IL • mrs@carlingtech.com  
West Region Sales Office, CA • wrsm@carlingtech.com

### **Asia-Pacific Headquarters**

Carling Technologies, Asia-Pacific Ltd.,  
Kowloon, Hong Kong  
Int + 852-2737-2277 • Fax: Int + 852-2736-9332  
Email: sales@carlingtech.com.hk

Shenzhen, China • shenzhen@carlingtech.com  
Shanghai, China • shanghai@carlingtech.com  
Pune, India • india@carlingtech.com  
Kaohsiung, Taiwan • taiwan@carlingtech.com  
Yokohama, Japan • japan@carlingtech.com

### **Europe / Middle East / Africa Headquarters**

Carling Technologies LTD  
4 Airport Business Park, Exeter Airport,  
Clyst Honiton, Exeter, Devon, EX5 2UL, UK  
Int + 44 1392-364422 • Fax: Int + 44 1392-364477  
Email: ltd.sales@carlingtech.com

GmbH, Germany • gmbh@carlingtech.com  
SAS, France • sas@carlingtech.com

REV\_SW\_V\_07\_2014



**Carling Technologies™**

Innovative Designs. Powerful Solutions.