

ULV8 SERIES ANTI-VANDAL SWITCH

ANTI-VANDAL SWITCHES
DETECTOR SWITCHES
DIP SWITCHES
KEYLOCK SWITCHES
NAVIGATION SWITCHES
PUSHBUTTON SWITCHES
ROCKER SWITCHES
ROTARY SWITCHES
SLIDE SWITCHES
SNAP ACTION SWITCHES
TACTILE SWITCHES
TOGGLE SWITCHES
CAP OPTIONS



APPLICATIONS / MARKETS



RoHS

SPECIFICATIONS

Electrical Rating: 3A, 125/250VAC
Mechanical Life: 1,000,000 cycles (momentary); 500,000 cycles (latching)
Electrical Life: 50,000 Cycles
Contact Resistance: 50mΩ
Insulation Resistance: 1000 MΩ @ 500VDC
Dielectric Strength: 2,000VAC
Operating/Storage Temperature: -20°C to 55°C
Travel: 3.2mm
Moisture Protection: IP67
Contact Arrangement: SPDT or DPDT
Actuation Force: Single Pole: 2.5N; Double Pole: 3.5N
Panel Thickness: 1-10mm
Hex Nut Torque: 5-14Nm
Mechanical Impact Protection: IK08
Agency Approvals: cURus

FEATURES & BENEFITS

- 25mm diameter panel cutout
- Ring illumination
- Multiple switch functions available
- Multiple illumination voltage options
- IP67 rated
- SPDT or DPDT
- UL Certified
- Soldered wire leads (300mm long) optional

PART NUMBER CONFIGURATOR

Series	Actuator	Terminal	Function	Body Finish	Actuator Finish	Contact Material	Lens Style	LED Color	Illumination Voltage
<input type="text" value="ULV8"/>	<input type="text" value="F - Flat"/>	<input type="text" value="2 - Solder"/> <input type="text" value="W - Wire Leads"/> 300mm long	<input type="text" value="3 - 1P ON-ON"/> <input type="text" value="B - 1P ON-(ON)*"/> <input type="text" value="G - 2P ON-ON"/> <input type="text" value="H - 2P ON-(ON)*"/>	<input type="text" value="S - Stainless Steel"/> <input type="text" value="1 - Black Anodized"/>	<input type="text" value="S - Stainless Steel"/> <input type="text" value="1 - Black Anodized"/>	<input type="text" value="None - Silver"/> <input type="text" value="G - Gold"/>	<input type="text" value="3 - Ring, moveable with actuator"/>	<input type="text" value="0 - White"/> <input type="text" value="1 - Red"/> <input type="text" value="2 - Orange"/> <input type="text" value="3 - Green"/> <input type="text" value="4 - Blue"/> <input type="text" value="5 - Yellow"/> <input type="text" value="G - Red / Green"/> <input type="text" value="P - Green / Yellow"/>	<input type="text" value="1 - 3V"/> <input type="text" value="3 - 6V"/> <input type="text" value="4 - 12V"/> <input type="text" value="5 - 24V"/> <input type="text" value="6 - 110V"/> <input type="text" value="7 - 220V"/>

NOTES:

*() denotes function is momentary

Specifications subject to change without notice 3.19.2019



E-SWITCH®

www.e-switch.com

800.867.2717

1

ULV8 SERIES ANTI-VANDAL SWITCH

BODY DIMENSIONS - SPDT

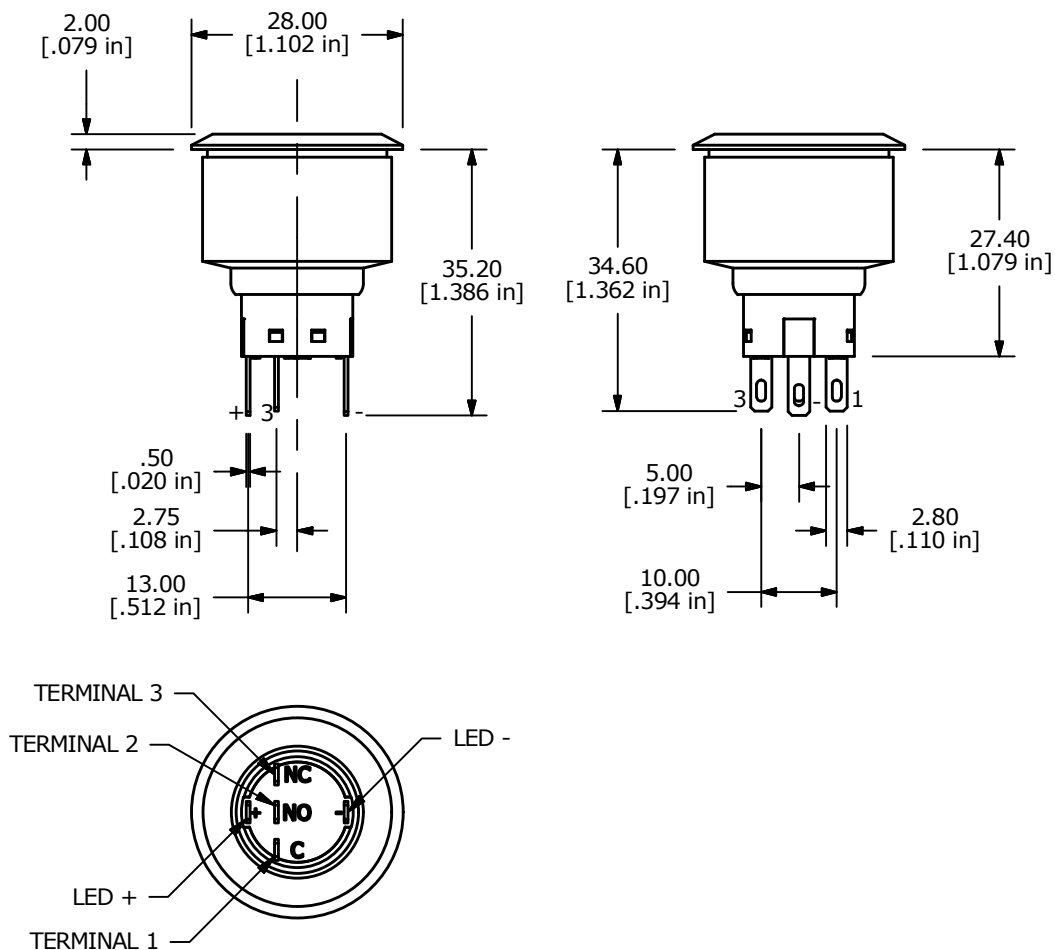

SPDT SWITCH DIMENSIONS

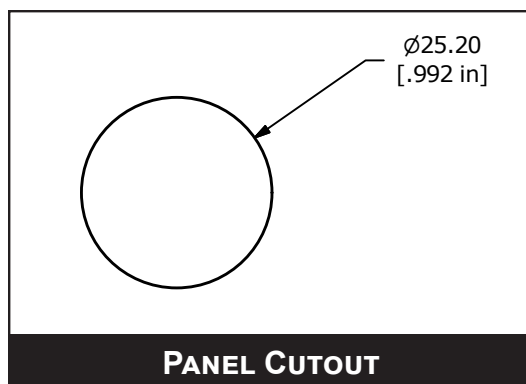

ULV8 SERIES ANTI-VANDAL SWITCH

BODY DIMENSIONS - DPDT

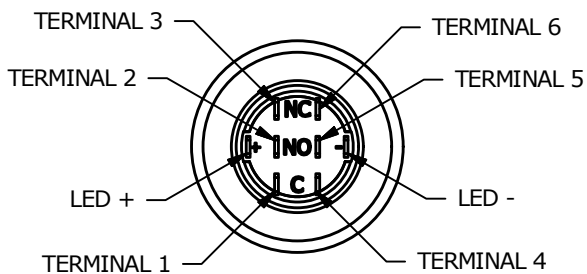
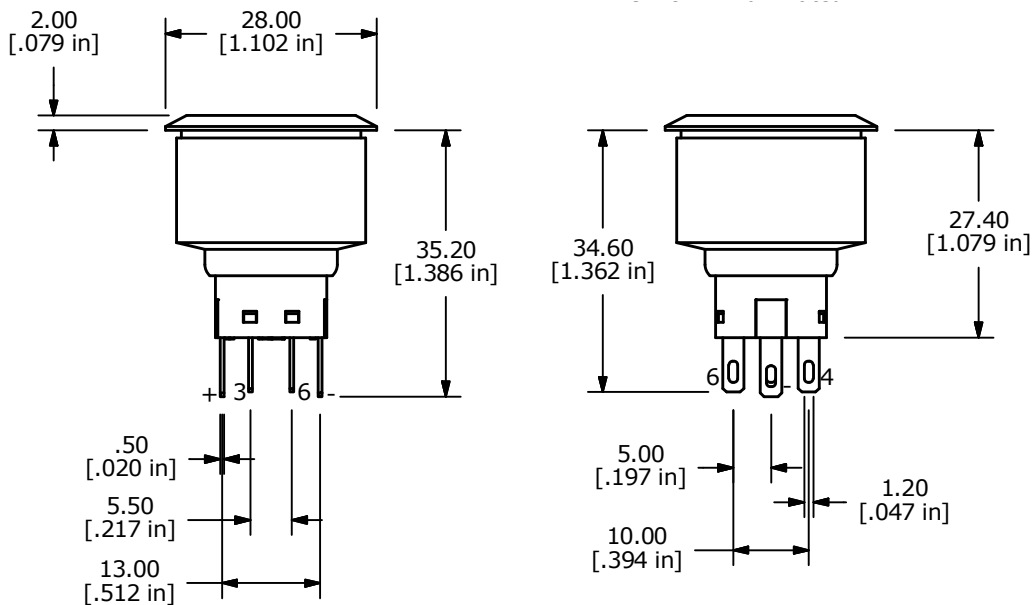

DPDT SWITCH DIMENSIONS

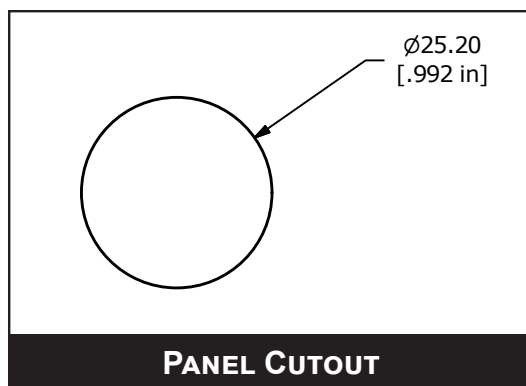

ULV8 SERIES ANTI-VANDAL SWITCH

SCHEMATICS

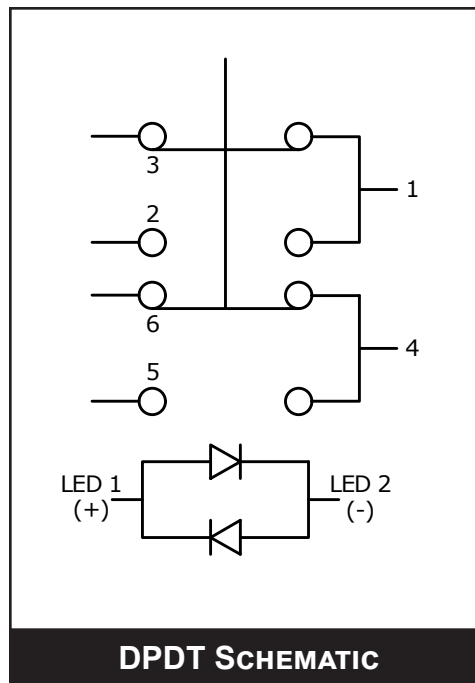
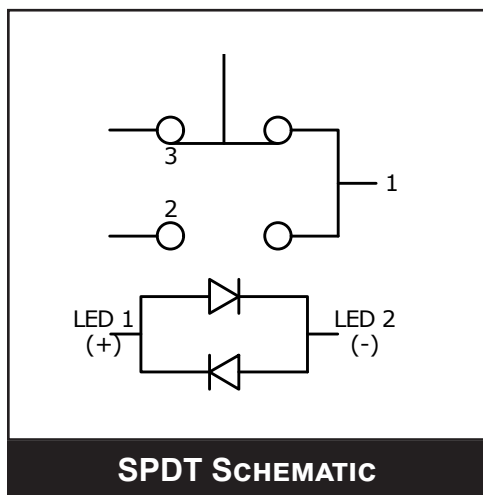

ACTUATOR OPTIONS

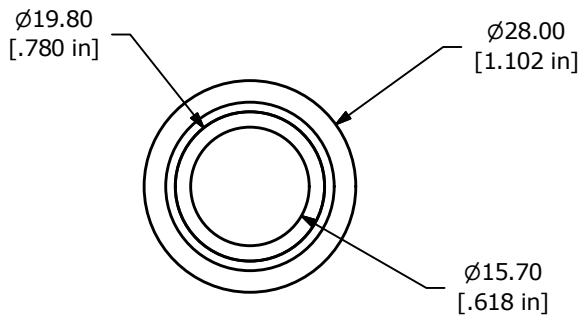

RING ILLUMINATED



ULV8 SERIES ANTI-VANDAL SWITCH

WIRE LEADS

SWITCH	WIRE	LENGTH
SW1-1	WIRE, 24AWG AWM UL1015, BLUE	300.0 [11.8 in]
SW1-2	WIRE, 24AWG AWM UL1015, PURPLE	300.0 [11.8 in]
SW1-3	WIRE, 24AWG AWM UL1015, GREEN	300.0 [11.8 in]
SW1-4	WIRE, 24AWG AWM UL1015, WHITE	300.0 [11.8 in]
SW1-5	WIRE, 24AWG AWM UL1015, ORANGE	300.0 [11.8 in]
SW1-6	WIRE, 24AWG AWM UL1015, YELLOW	300.0 [11.8 in]
SW1- (-)	WIRE, 24AWG AWM UL1015, BLACK	300.0 [11.8 in]
SW1- (+)	WIRE, 24AWG AWM UL1015, RED	300.0 [11.8 in]

** WIRE LEADS PROVIDED ARE DEPENDANT ON THE FUNCTION SELECTED **

