

Amphenol TV-CTV Tri-Start MIL-DTL-38999 Series III



COMBINES HIGH COUPLING DURABILITY WITH EMI-SHIELDING AND MOISTURE & CORROSION RESISTANCE

TV-CTV Tri-Start MIL-DTL-38999 Series III connectors have high-density contact arrangements in a miniature circular shell. Originally designed for the high-performance requirements of military and commercial aircraft, these circular connectors are perfect for applications requiring extremely reliable interconnections. TV's are quick-mating and environmentally-sealed.

- Space-rated Class G outgassing available in 48 hours
- Intermateable with Deutsch, ITT Cannon, Souriau and all MIL-DTL-38999 series III connectors
- Formerly MIL-C-38999

APPLICATIONS

- High-performance military aircraft
- Commercial airlines
- Communications equipment
- Armored personnel carriers & tanks
- Missiles
- Shipboard

FEATURES

HIGH-RELIABILITY

D38999 - TV style connectors are used in some of the most rigorous environments and must perform flawlessly under wide temperature ranges, high vibrations and be resistant to a vast array of contaminants. Visual confirmation of mating is provided by the plug coupling nut covering a red band on the mating shell.

OUTSTANDING EMI-SHIELDING PROTECTION

These connectors provide excellent signal integrity due to the shielded mating system that utilizes 360-degree shell grounding fingers, providing protection of up to 65 dB at 10 GHz.

OPERATES AT EXTREME TEMPERATURES

These connectors operate in temperatures from -85°F to +392°F (-65°C to +200°C).

HIGH-DENSITY CONNECTORS

If space is at a premium, TV connectors offer up to 128 contacts per connector. Ideally suited for the demands of digital electronics on fly-by wire aircraft, advanced robotics, and critical industrial equipment.

SELF-LOCKING CONNECTOR SYSTEMS

Self-locking coupling nuts and self-locking endbell accessory hardware provide the best performance for threaded connectors in high-vibration applications.

BROAD RANGE OF MILITARY AND COMMERCIAL ACCESSORIES

Many military-standard endbells to M85049 specifications and a wide array of cable termination styles are available. Straight, 45 and 90-degree endbells come in many styles from cost-effective standard clamp to shielded, environmentally-sealed and everything in between.

CONTACT PROTECTION

TV connectors are designed to be scoop-proof. Pin contacts are recessed to prevent contact damage and contact shorting when connector halves are mated.

MIL-DTL-38999-APPROVED

TV's are fully-intermateable and intermountable with all other manufacturer's MIL-DTL-38999 series III connectors.

TECHNICAL
SPECIFICATIONS

MATERIALS AND FINISHES

Shell & Plating	ALUMINUM ALLOY	COMPOSITE	STAINLESS STEEL	MARINE MATERIAL
	W - Olive drab chromate over cadmium over electroless nickel per QQ-P-416	J - Olive drab cadmium plate per QQ-P-416	K - Conductive, corrosion-resistant steel passivated	RB - Nickel aluminum bronze
	DT - Durmalon™	M - Conductive electroless nickel plating	S - Electrodeposited nickel per QQ-N-290	
	W52 - Olive drab zinc cobalt			
	F - Electroless nickel QQ-N-290			
	Z - Black zinc nickel			
	ZN - Black Zinc nickel (Europe only)			
Contacts	Copper alloy			
Plating	Gold-plated, 50 microinches per MIL-G-45204 type II, grade C, class I			
Insulator	Hard dielectric wafer which contains tines for high-reliability retention of crimp contacts			
Grommet & Seals	Silicone-based elastomer			
Grounding Springs	Beryllium copper (grounded plug only)			

ELECTRICAL DATA

Contact Sizes	SERVICE RATING				
Operating Voltage & Test Voltage (Unmated Condition)	TEST VOLTAGES	N	M	I	II
	Sea Level	1000	1300	1800	2300
	100,000 Feet	200	200	200	200

Current Rating by Contact Size & Wire Accommodation (Test Amps)	WIRE SIZE	22D	20	16	12	10	8
	28	1.5	-	-	-	-	-
26	2.0	-	-	-	-	-	-
24	3.0	3.0	-	-	-	-	-
22	5.0	5.0	-	-	-	-	-
20	-	7.5	7.5	-	-	-	-
18	-	-	10.0	-	-	-	-
16	-	-	13.0	-	-	-	-
14	-	-	-	17.0	-	-	-
12	-	-	-	23.0	-	-	-
10 (power)	-	-	-	-	33.0	-	-
8 (power)	-	-	-	-	-	46.0	-

Contact Resistance of Mated Contacts End to-End	CONTACT SIZE	MAXIMUM MILLIVOLT DROP
	22D	73
20	55	
16	49	
12	42	
10 (power)	33	
8 (power)	26	

Insulation Resistance 5,000 megohms minimum

MECHANICAL

Operating Temperature W, W52, RB, J & ZN plating -65°C to 175°C (-85°F to 347°F)
DT, F, M, K & S plating -65°C to 200°C (-85°F to 392°F)

Sealing Against sand, dust per MIL-STD-202 & ice resistance

Wire Sealing Range

CONTACT SIZE	MINIMUM INCHES	MAXIMUM INCHES	MINIMUM MM	MAXIMUM MM
22D	0.030	0.054	0.76	1.37
20	0.040	0.083	1.02	2.11
16	0.065	0.109	1.65	2.77
12	0.097	0.142	2.46	3.61
10	0.135	0.162	3.42	4.12
10 (power)	0.135	0.162	3.42	4.12
8 (power)	0.135	0.155	3.43	3.94
8 (coax)	0.135	0.155	3.43	3.94
8 (twinax)	0.124	0.134	3.15	3.40

TECHNICAL SPECIFICATIONS

Insulation Strip Length	CONTACT SIZE		STRIP LENGTH	
	22D		.125 (3.18)	
	20		.188 (4.77)	
	16		.188 (4.77)	
	12		.188 (4.77)	
	10 (power)		.335 (8.51)	
	8 (power)		.470 (11.94)	
Mating Life	500 cycles minimum			
Salt Spray	Finish W, S, K, T, & Z: 500 hours per MIL-STD-1334A method 1001 condition C Finish F: 48 hours per MIL-STD-1334A method 1001 condition C Finish J & K: 2000 hours per MIL-STD-1334A method 1001 condition C Finish W52: 48 hours Finish RB: 500 hours Finish DT, DZ & ZN: 500 hours			
Temperature Durability	Finish W: 175°C (347°F), Finish F: 200°C (392°F), mated, wired test period 1000 hours to MIL-STD-1344 Method 1005 Finish DT, M, K & S: 200°C (392°F) Finish J, RB, W52, DZ & ZN: 175°C (347°F)			
Chemical Resistance	Lubricating oils, hydraulic fluids, coolants, deicing fluids per MIL-STD-1344A Method 1016 condition A-1			
Sine Vibration	60g at -55°C per MIL-DTL-38999K 4.5.22.2.1			
Random Vibration	49.5 grms at ambient temperatures			
Shock	300 grms			
EMI-Shielding Effectiveness	100 MHz to 10 GHz - minimum attenuation of 50dB			
Contact Type	Crimp, fibre optic, coax, twinax, or printed circuit			
Number of Circuits	2 to 128			
Contact Insertion	Rear-insertion/rear-extraction with simple plastic or high-quality metal hand tools			
Contact Retention	Per MIL-DTL-38999K tested to MIL-STD-1344A method 2007			
	CONTACT	AXIAL LOAD NEWTONS ±10%	AXIAL LOAD POUNDS ±10%	
	22D	44	10	
	20	67	15	
	16	111	25	
	12	111	25	
	10	111	25	
	8	111	25	
Polarization	Five keyways with optional master keyway rotations (Note: insert and main keyways remain fixed)			
Approvals	MIL-DTL-38999			

All dimensions in inches (millimeters in parenthesis)

CROSS-SECTION

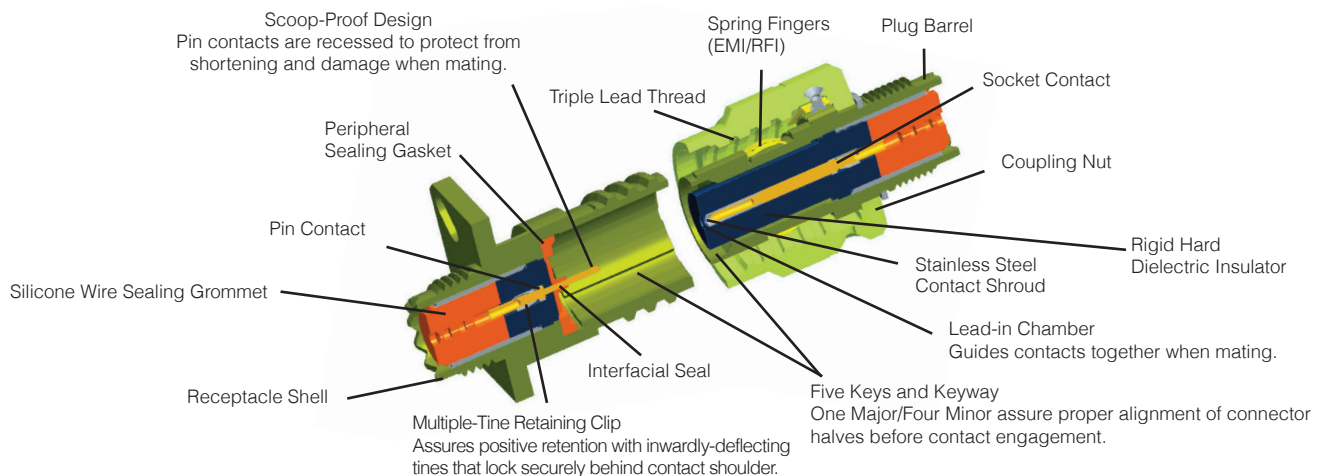

CREATE YOUR PART NUMBER - MILITARY

1	2	3	4	5	6
D38999/20	F	A35	P	N	-LC
SHELL STYLE	FINISH	LAYOUT	CONTACT	POLARIZATION	MODIFIER

(military part number example)

STEP 1: SELECT SHELL STYLE, PLUG OR RECEPTACLE

RECEPTACLES ← Mates with → PLUGS

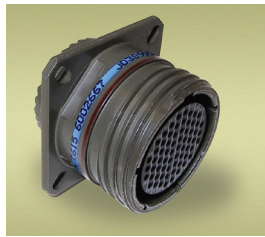

D38999/20
Wall Mount Receptacle



D38999/24
Jam Nut Receptacle

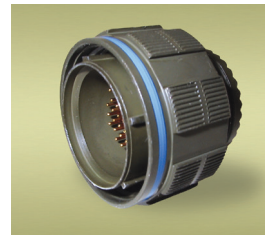

D38999/26
Straight Cable Plug

Lanyard Release Plug

Contact us for more details.

HERMETICS

Please contact us
 D38999/21 - Box Mount
 D38999/23 - Jam Nut
 D38999/25 - Solder Mount
 D38999/27 - Weld Mount



Available with PC pins. Contact us for details.

STEP 2: SELECT CLASS

- F** = Electroless Nickel (Aluminum)
- K** = Stainless Steel - Firewall - 45dB
- W** = Olive Drab Chromate over Cadmium (Aluminum)
- S** = Stainless Steel/Electroless Nickel -65dB
- J** = Composite (Olive Drab Chromate over Cadmium)
- M** = Composite (Electroless Nickel)
- T** = Nickel - PTFE (Aluminum) Durmalon™

CONTACT US FOR DETAILS

- G** = Space Grade, Outgassed
- L** = Corrosion-Resistant Steel/Electrodeposited Nickel
- Y** = Hermetic Stainless Steel
- N** = Hermetic Stainless Steel/Electrodeposited Nickel
- Z** = Black Zinc Nickel

NOTE: Part numbers will be prefixed with the United States Government Certification Marks "J" or "JAN". The Certification and Registration 504,860 for "JAN" and 1,586,261 for the "J" Certification marks. EXAMPLE: JD38999/20FA35PN

STEP 3: SELECT LAYOUT

For listing by # of contacts, → see pages 228-231.

Military D38999 Layout	Service Rating	Contacts						Available in Hermetic Pin Layouts	
		Total Number	22D	20	16	12	10		8
A35	M	6	6						P
A98	I	3		3					P
B2	I	2			2				
B5	I	5		5					P
B35	M	13	13						P
B98	I	6		6					P
B99	I	7		7					
C4	I	4			4				P
C8	I	8		8					P
C35	M	22	22						P
C98	I	10		10					P
D5	II	5			5				P
D15	I	15		14	1				P
D18	I	18		18					P
D19	I	19		19					P
D35	M	37	37						P
D97	I	12		8	4				P
E2	M	39	38					1**	
E6	I	6				6			P
E8	II	8			8				P
E26	I	26		26					P
E35	M	55	55						P
E99	I	23		21	2				
F11	II	11			11				P
F18	M	18	14					4**	
F28	I	28		26	2				
F32	I	32		32					P
F35	M	66	66						P
G11	I	11				11			
G16	II	16			16				P
G35	M	79	79						P
G39	I	39		37	2				P
G41	I	41	41						P
G75	M	4						4*	(See Note)
H21	II	21			21				P
H35	M	100	100						P
H53	I	53		53					P
H55	I	55		55					P
J4	I	56		48	8				P
J7	TWINAX	99	97					2**	
J8	TWINAX	8						8**	
J11	N	11		2			9		
J19	I	19				19			P
J20	N	30		10	13	4♦		3**	
J24	I	24			12	12			P
J29	I	29			29				
J35	M	128	128						P
J37	I	37			37				
J43	I	43		23	20				
J46	I	46		40	4	2*			
J61	I	61		61					P
J90	I	46		40	4			2**	

P - Pin inserts only (Contact us for socket availability)
 Note: MS connector G75 is supplied with size 8 twinax.
 Proprietary connector 21-75 is supplied with size 8 coax.
 Coaxial type contacts are only rated for 175°C (347°F).

*Coax **Twinax
 ♦J20 is supplied with 2-#12 coax and 2-#12 shielded contacts
 Contact us for more information.

STEP 4: SELECT CONTACT

- P = Pin
 - S = Socket
 - H = 1500-Mating Cycle Pins (Composite type only)
 - J = 1500-Mating Cycle Socket (Composite type only)
 - A = Less Pin Contacts*
 - B = Less Socket Contacts*
- * Use only for special contact types (PC Pin, Thermocouple, Fiberoptic).

STEP 5: SELECT POLARIZATION

- N = Normal Standard
- A = Highly-Popular
- B = Limited Availability
- C = Check for Availability
- D = Check for Availability

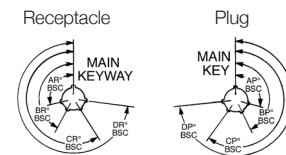

SHELL SIZE		MINOR KEY LOCATION				
		AR ^o & AP ^o	BR ^o & BP ^o	CR ^o & CP ^o	DR ^o & DP ^o	
A	N	105	140	215	265	
	A	102	132	248	320	
	B	80	118	230	312	
	C	35	140	205	275	
	D	64	155	234	304	
	E	91	131	197	240	
B	N	95	141	208	236	
	A	113	156	182	292	
	D	B	90	145	195	252
		C	53	156	220	255
		D	119	146	176	298
E	E	51	141	184	242	
	N	80	142	196	293	
	F	A	135	170	200	310
		B	49	169	200	244
		C	66	140	200	257
D		62	145	180	280	
G	E	79	153	197	272	
	N	80	142	196	293	
	H	A	135	170	200	310
		B	49	169	200	244
		C	66	140	200	257
D		62	145	180	280	
J	E	79	153	197	272	

STEP 6: MODIFIER

Omit for standard contacts
LC = For use with standard contacts but supplied without contacts, seal plugs or tools. (P.O. must state Less Contacts.) LC is not marked on parts.



UNIVERSAL MOD (KITTED NOT MARKED ON PART)

- U = Universal endbell for heat shrink tube or boots
- US = Universal endbell with shielding spring
- UT = Universal endbell with shielding tape
- UW = Universal endbell with shielding tape and spring
- SB or HSB = Heavy-duty heat shrink boot



CG = Cord Grip Adapter



CA = Flexible Conduit Adapter

CREATE YOUR PART NUMBER - COMMERCIAL

1	2	3	4	5	6
TVP00	RW-	9-35	P	-	-LC
SHELL STYLE	FINISH	LAYOUT	CONTACT	POLARIZATION	MODIFIER

(example)

STEP 1: SELECT SHELL STYLE, PLUG OR RECEPTACLE



NOTE: To be used with Service Classes RF, RK & RS only for 200°C. TVS/CTVS TVPS/CTVPS

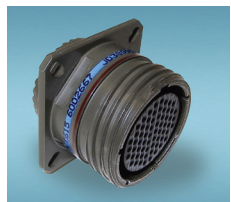

TVP00/TVPS00
CTVP00/CTVPS00
Wall Mount Receptacle

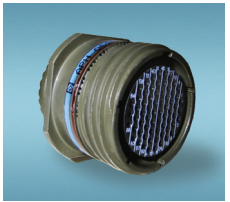

TV01/TVS01
CTV01/CTVPS01
In-Line Receptacle

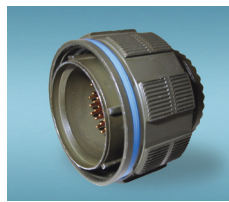

TV06/TVS06
CTV06/CTVPS06
Straight Cable Plug

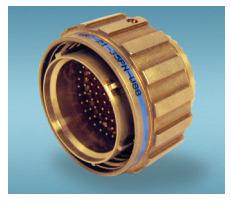

TVS06RB_W88
Straight Cable Plug
Heavy Duty Coupling Nut

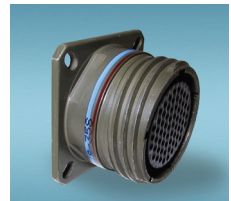

TVP02/TVPS02
CTVP02/CTVPS02
Box Mount Receptacle

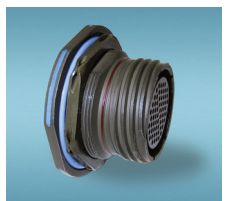

TV07/TVS07
CTV07/CTVPS07
Jam Nut Receptacle

TV09/TVS09
Flange Mounting Plug
Please contact us for details

NOTE: For high-vibration and harsh-environment applications. Please contact us. (TV26/HTV26)

STEP 2: SELECT CLASS

- RB** = Marine Nickel Aluminum Bronze
- RF** = Electroless Nickel (Aluminum)
- RK** = Stainless Steel - Firewall - 45dB
- RW** = Olive Drab Chromate over Cadmium (Aluminum)
- RS** = Stainless Steel/Electroless Nickel - 65dB
- DZ** = Black Zinc Nickel (ROHS-US)
- DT** = Durmalon™ (ROHS) Contact us for details
- ZN** = Black Zinc Nickel (ROHS-EU)
- Y** = Hermetic Stainless Steel
- YN** = Hermetic Stainless Steel/Electroless Nickel
- RGF** = Electroless Nickel Plated Ground Plane Aluminum, 200°C
- RGW** = Olive Drab Cadmium Plated Ground Plane Aluminum, 175°C
- RQB** = Marine Nickel Aluminum Bronze, with Quadrax Contact

- RGQB** = Same as RQB, Ground Plane
- RQF** = Same as RF, except with Quadrax Contacts
- RGQF** = Same as RQF, except with Quadrax Contacts
- RQK** = Stainless Steel, with Quadrax Contacts
- RGQK** = Same as RQK, Ground Plane
- QDT** = Durmalon™ (RoHS), with Quadrax Contacts
- GQDT** = Same as QDT, Ground Plane
- RQZ** = Same as ZN, except with Quadrax Contacts
- RGQZ** = Same as RQZ, Ground plane
- RQW** = Same as RW, except with Quadrax Contacts
- RGQW** = Same as RGW, except with Quadrax Contacts
- RX** = Alternate Finish, requires special variation suffix

CONTACT US FOR DETAILS

Not Firewall Capable

HERMETICS
Please contact us

TVPS02 - Box Mount	TVS07 - Jam Nut
TVSIY - Solder Mount	TVSHIY - Weld Mount



Available with PC pins. Contact us for details.

STEP 3: SELECT LAYOUT

For listing by # of contacts, → see pages 228-231.

Commercial TV/CTV Layout	Service Rating	Contacts							Available in Hermetic Pin Layouts	
		Total Number	22D	20	16	12	10	8		
9-5 QG	Grounded	1							1**	
9-35	M	6	6							P
9-94•	M	2		2						
9-98	I	3		3						P
11-01	Twinax	1							1**	
11-2• G	I	2			2					
11-4•		4		4						
11-5	I	5		5						P
11-35	M	13	13							P
11-54•	II	4	4							
11-98	I	6		6						P
11-99	I	7		7						
13-4 G	I	4			4					P
13-8	I	8		8						P
13-13	I, Fibre Optic	4			2	2				
13-35	M	22	22							P
13-98	I	10		10						P
15-4•	I	4				4				
15-5 G	II	5			5					P
15-15	I	15		14	1					P
15-18	I	18		18						P
15-19	I	19		19						P
15-35	M	37	37							P
15-97	I	12		8	4					P
17-2•	M	39	38						1**	
17-6	I	6				6				P
17-8 G	II	8			8					P
17-20	M	20	16				4			
17-22• Q	Coax	4					2*		2*	
17-26	I	26		26						P
17-35	M	55	55							P
17-52 Q	M	2							2**	
17-60 Q	I/Coax	10	8						2*	
17-99	I	23		21	2					
19-AD Q	I/Twinax	17		16					1**	
19-11 G	II	11			11					P
19-17	M	17	10	1	4				2**	
19-18• Q	M	18	14						4**	
19-28	I	28		26	2					
19-31• Q	M	15	12			1			2	
19-32	I	32		32						P
19-35	M	66	66							P
21-11 G	I	11				11				
21-16 G	II	16			16					P
21-29	I	27		19	4	4				
21-35	M	79	79							P
21-39	I	39		37	2					P
21-41	I	41		41						P
21-48		4							4***	
21-75 QG	M	4							4*	(See Note)
21-79 Q	II	19	17						2*	
23-6 QG	M	6							6**	
23-14•	I	14				14				
23-21 G	II	21			21					P
23-35	M	100	100							P
23-53	I	53		53						P
23-54•	M	53	40		9	4				
23-55•	I	55		55						P
25-4	I	56		48	8					P
25-7• Q	Twinax	99	97						2**	
25-8• QG	Twinax	8							8**	
25-11•	N	11		2			9			
25-17•	M	42	36						6**	
25-19 G	I	19				19				P
25-20• Q	N	30		10	13	4♦			3**	
25-24 G	I	24			12	12				P
25-26•	I	25		16		5			4*	
25-29 G	I	29			29					
25-35	M	128	128							P
25-37• G	I	37			37					
25-41	I	41	22	3	11	2*			3**	
25-43•	I	43		23	20					
25-46• Q	I	46		40	4				2*	
25-61	I	61		61						P
25-62• Q	I	12			8				4	
25-90•	I	46		40	4				2**	
25-F4•	M/I	66	49	13	4					

STEP 4: SELECT CONTACT

- P** = Pin
 - S** = Socket
 - H** = 1500-Mating Cycle Pins (Composite type only)
 - J** = 1500-Mating Cycle Socket (Composite type only)
 - A** = Less Pin Contacts*
 - B** = Less Socket Contacts*
- * Use only for special contact types (PC pin, thermocouple, fibre optic).

STEP 5: SELECT POLARIZATION

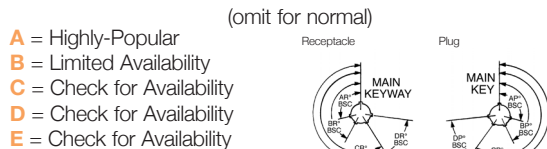

SHELL SIZE		MINOR KEY LOCATION			
		AR ^o & AP ^o	BR ^o & BP ^o	CR ^o & CP ^o	DR ^o & DP ^o
9	N	105	140	215	265
	A	102	132	248	320
	B	80	118	230	312
	C	35	140	205	275
	D	64	155	234	304
11	E	91	131	197	240
	N	95	141	208	236
13	A	113	156	182	292
	B	90	145	195	252
15	C	53	156	220	255
	D	119	146	176	298
	E	51	141	184	242
	N	80	142	196	293
	A	135	170	200	310
17	B	49	169	200	244
	C	66	140	200	257
	D	62	145	180	280
	E	79	153	197	272
	N	80	142	196	293
21	A	135	170	200	310
	B	49	169	200	244
23	C	66	140	200	257
	D	62	145	180	280
	E	79	153	197	272
	N	80	142	196	293
	A	135	170	200	310
25	B	49	169	200	244
	C	66	140	200	257
	D	62	145	180	280
	E	79	153	197	272

STEP 6: MODIFIER

→ See page 225 for more Modifiers.

Omit for standard contacts
LC = For use with standard contacts but supplied without contacts, seal plugs or tools. (P.O. must state Less Contacts.) LC is not marked on parts.

W52 = Olive Drab Zinc Cobalt
W88 = Heavy-Duty Plug (RB Only)

- Not tooled for 02-R **Q** = Available in Quadrax Layouts
- ♦ 25-20 is supplied with 2-#12 coax and 2-#12 shielded contacts
- * Coax ** Twinax *** Power (EU version) available. Contact us for more information.
- G** = Groundplane option available. 9-5 is exclusively groundplane.

Note: Proprietary connector 21-75 is supplied with size 8 coax.
 Coaxial type contacts are only rated for 175°C (347°F).

LAYOUT BY NUMBER OF CONTACTS

View of Mating-Face of Pin Insert



CONTACTS 1 2 3 4

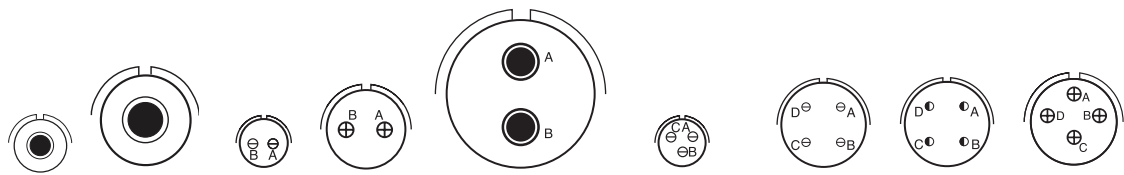

D38999 LAYOUT	-	-	-	B2	-	A98	-	-	C4
TV/CTV LAYOUT	9-5Q	11-01	9-94*	11-2*	17-52Q	9-98	11-4*	11-54	13-4
# OF CONTACTS	1-#8	1-#8**	2-#20	2-#16	2-#8**	3-#20	4-#20	4-#22D	4-#16
SERVICE RATING	M	TWINAX	M	I	M	I	I	II	I

CONTACTS 4

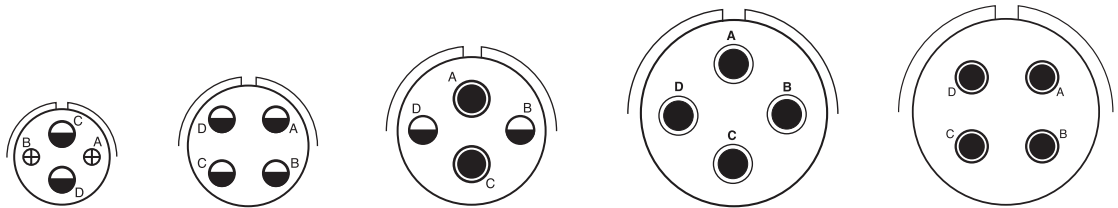

D38999 LAYOUT	-	-	-	-	G75
TV/CTV LAYOUT	13-13	15-4*	17-22*Q	21-48	21-75Q
# OF CONTACTS	2-#16, 2-#12	4-#12	2-#12*, 2-#8*	4-#8***	4-#8* or **
SERVICE RATING	I, FIBER OPTIC	I	COAX	-	M

CONTACTS 5 6

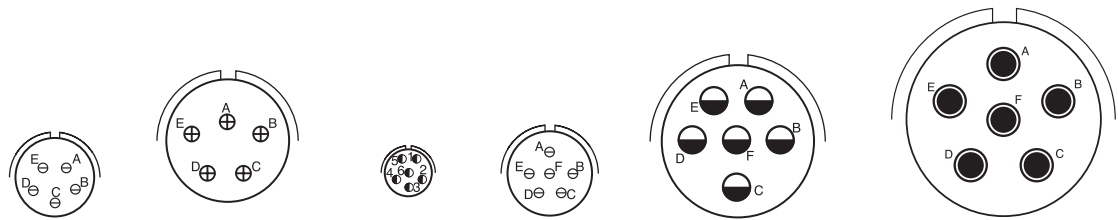

D38999 LAYOUT	B5	D5	A35	B98	E6	-
TV/CTV LAYOUT	11-5*	15-5	9-35	11-98	17-6	23-6Q
# OF CONTACTS	5-#20	5-#16	6-#22D	6-#20	6-#12	6-#8**
SERVICE RATING	I	II	M	I	I	M

CONTACTS 7 8 10

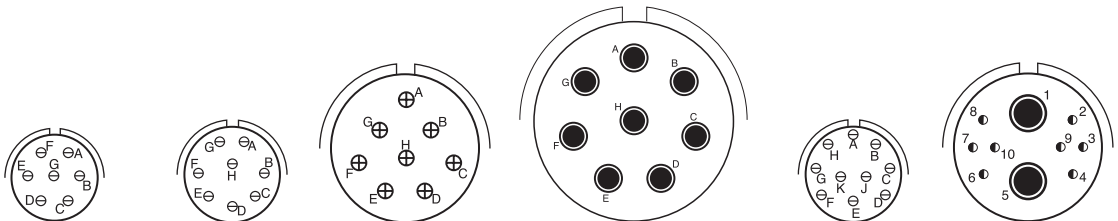

D38999 LAYOUT	B99	C8	E8	J8	C98	-
TV/CTV LAYOUT	11-99	13-8	17-8	25-8*Q	13-98	17-60Q
# OF CONTACTS	7-#20	8-#20	8-#16	8-#8**	10-#20	8-#22D, 2-#8*
SERVICE RATING	I	I	II	TWINAX	I	I/COAX

*Coax **Twinax ***Power (EU version) available •Not Tooled for 02-R Q Quadrax Contact us for more information.

LAYOUT BY NUMBER OF CONTACTS

View of Mating-Face of Pin Insert



CONTACTS	11			12	
D38999 LAYOUT	F11	G11	J11	D97	-
TV/CTV LAYOUT	19-11	21-11	25-11*	15-97	25-62Q
# OF CONTACTS	11-#16	11-#12	2-#20, 9-#10	8-#20, 4-#16	8-#16, 4-#8**
SERVICE RATING	II	I	N	I	I
CONTACTS	13	14	15		16
D38999 LAYOUT	B35	-	D15	-	G16
TV/CTV LAYOUT	11-35	23-14*	15-15	19-31*Q	21-16
# OF CONTACTS	13-#22D	14-#12	14-#20, 1-#16	12-#22D, 1-#12, 2-#8*	16-#16
SERVICE RATING	M	I	I	M	II
CONTACTS	17			18	
D38999 LAYOUT	-	-	D18	F18	
TV/CTV LAYOUT	19-ADQ	19-17	15-18	19-18*Q	
# OF CONTACTS	16-#20, 1-#8**	10-#22D, 1-#20, 4-#16, 2-#8**	18-#20	14-#22D, 4-#8**	
SERVICE RATING	I/TWINAX	M	I	M	
CONTACTS	19			20	
D38999 LAYOUT	D19	-	J19	-	
TV/CTV LAYOUT	15-19*	21-79Q	25-19	17-20	
# OF CONTACTS	19-#20	17-#22D, 2-#8*	19-#12	16-#22D, 4-#12	
SERVICE RATING	I	II	I	M	

*Coax **Twinax ***Power *Not Tooled for 02-R Q Quadraz Contact us for more information.

LAYOUT BY NUMBER OF CONTACTS

View of Mating-Face of Pin Insert

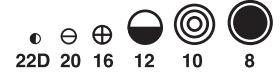

CONTACTS	21	22	23	24
D38999 LAYOUT TV/CTV LAYOUT # OF CONTACTS SERVICE RATING	H21 23-21 21-#16 II	C35 13-35 22-#22D M	E99 17-99 21-#20, 2-#16 I	J24 25-24 12-#16, 12-#12 I
CONTACTS	25	26	27	28
D38999 LAYOUT TV/CTV LAYOUT # OF CONTACTS SERVICE RATING	- 25-26•Q 16-#20, 5-#12, 4-#8* I	E26 17-26 26-#20 I	- 21-29 19-#20, 4-#16, 4-#12 I	F28 19-28 26-#20, 2-#16 I
CONTACTS	29	30	32	37
D38999 LAYOUT TV/CTV LAYOUT # OF CONTACTS SERVICE RATING	J29 25-29 29-#16 I	J20 25-20•Q 10-#20, 13-#16, 4-#12♦, 3-#8*** N	F32 19-32 32-#20 I	J37 25-37• 37-#16 I
CONTACTS	37	39	41	
D38999 LAYOUT TV/CTV LAYOUT # OF CONTACTS SERVICE RATING	D35 15-35 37-#22D M	E2 17-2 38-#22D, 1-#8*** M	G39 21-39 37-#20, 2-#16 I	G41 21-41 41-#20 I
				- 25-41 22-#22D, 3-#20, 11-#16, 2-#12*, 3-#8*** I

*Coax **Twinax ***Power •Not Toolled for 02-R Q Quadrax Contact us for more information. ♦ 25-20 is supplied with 2-#12 coax and 2-#12 shielded contacts

LAYOUT BY NUMBER OF CONTACTS

View of Mating-Face of Pin Insert



CONTACTS 42 43 46

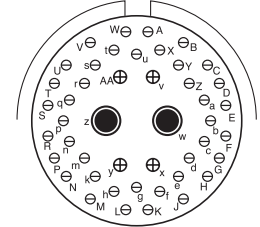
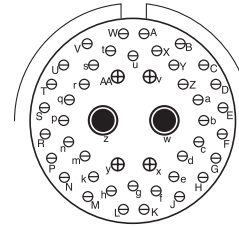
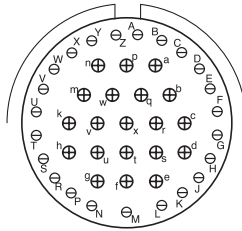
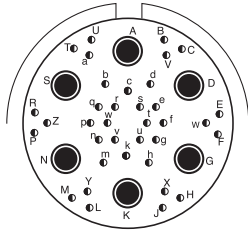

D38999 LAYOUT TV/CTV LAYOUT
OF CONTACTS
SERVICE RATING

-
25-17*
36-#22D, 6-#8***
M

J43
25-43*
23-#20, 20-#16
I

J46
25-46*Q
40-#20, 4-#16, 2-#8*
I

J90
25-90
40-#20, 4-#16, 2-#8***
I

CONTACTS 53 55

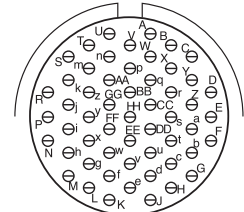
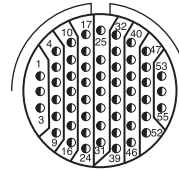
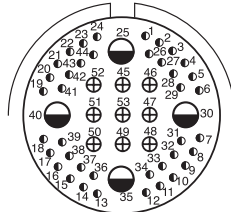
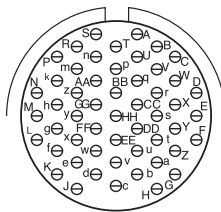

D38999 LAYOUT TV/CTV LAYOUT
OF CONTACTS
SERVICE RATING

H53
23-53
53-#20
I

-
23-54*
40-#22D, 9-#16, 4-#12
M

E35
17-35
55-#22D
M

H55
23-55*
55-#20
I

CONTACTS 56 61 66

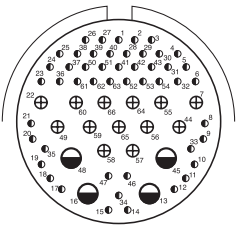
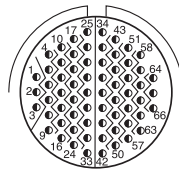
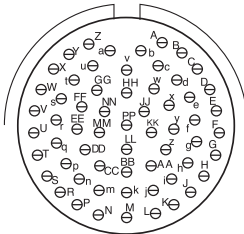
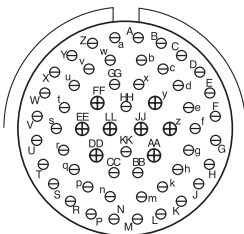

D38999 LAYOUT TV/CTV LAYOUT
OF CONTACTS
SERVICE RATING

J4
25-4
48-#20, 8-#16
I

J61
25-61
61-#20
I

F35
19-35
66-#22D
M

-
25-F4*
49-#22D, 13-#16, 4-#12
M/I

CONTACTS 79 99 100 128

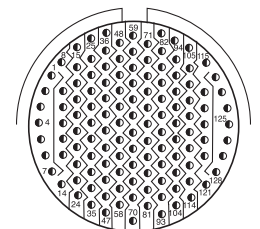
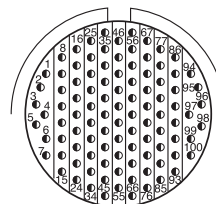
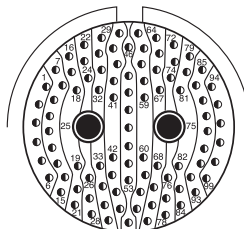
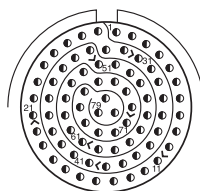

D38999 LAYOUT TV/CTV LAYOUT
OF CONTACTS
SERVICE RATING

G35
21-35
79-#22D
M

J7
25-7*Q
97-#22D, 2-#8***
TWINAX

H35
23-35
100-#22D
M

J35
25-35
128-#22D
M

*Coax **Twinax ***Power •Not Toolled for 02-R Q Quadax Contact us for more information.

CONTACTS

PINS

CONTACT SIZE	WIRE SIZE AWG	PIN CONTACT PART NUMBER	COLOR BANDS			WIRE STRIP LENGTHS	WIRE RANGE		WIRE HOLE FILLER	COLOR
			1	2	3		MIN.	MAX.		
22D	22,24,26 & 28	M39029/58-360	Orange	Blue	Black	.125 (3.18)	.030 (0.76)	.054 (1.37)	MS27488-22-2	Black
		M39029/107-620#	Blue	Red	Black					
20	20,22 & 24	M39029/58-363	Orange	Blue	Orange	.188 (4.77)	.040 (1.02)	.083 (2.11)	MS27488-20-2	Red
		M39029/107-621#	Blue	Red	Brown					
16	16,18 & 20	M39029/58-364	Orange	Blue	Yellow	.188 (4.77)	.065 (1.65)	.109 (2.77)	MS27488-16-2	Green
		M39029/107-621#	Blue	Red	Brown					
12	12 & 14	M39029/58-365	Orange	Blue	Green	.188 (4.77)	.097 (2.46)	.142 (3.61)	MS27488-12-2	Yellow
		M39029/107-623#	Blue	Red	Orange					
10	10 & 12	M39029/58-528	Green	Red	Gray	.335 (8.51)	.135 (3.42)	.162 (4.12)	M85049/81-10	Green
8	Coax* RG180B/U RG195A/U	M39029/60-367	Orange	Blue	Violet	Detailed instructions included with contacts	.135 (3.42)	.162 (4.12)	MS27488-8-3	Red
8	Twinax** M17/M176-0002	M39029/90-529	Green	Red	White		.124 (3.15)	.134 (3.40)	MS27488-8-3	Red
8 Power	8	10-497448-075	-	-	-	.470 (11.94)	.135 (3.42)	.162 (4.12)	MS27488-8-3	Red
8 Power	10	10-497448-095	-	-	-	.470 (11.94)	.135 (3.42)	.162 (4.12)	MS27488-8-3	Red
8 (Power-EU)	8	900-197	-	-	-	.393 (10.0)	.135 (3.42)	.162 (4.12)	MS27488-8-3	Red

#1500 Mating Cycle Contacts *Coax **Twinax call for details. For fibre optic contacts, please contact us.

SOCKETS

CONTACT SIZE	WIRE SIZE AWG	SOCKET CONTACT PART NUMBER	COLOR BANDS			WIRE STRIP LENGTHS	WIRE RANGE		WIRE HOLE FILLER	COLOR
			1	2	3		MIN.	MAX.		
22D	22,24,26 & 28	M39029/56-348	Orange	Yellow	Gray	.125 (3.18)	.030 (0.76)	.054 (1.37)	MS27488-22-2	Black
		M39029/106-614#	Blue	Brown	Yellow					
20	20, 22 & 24	M39029/56-351	Orange	Green	Brown	.188 (4.77)	.040 (1.02)	.083 (2.11)	MS27488-20-2	Red
		M39029/106-615#	Blue	Brown	Green					
16	16,18 & 20	M39029/56-352	Orange	Green	Red	.188 (4.77)	.065 (1.65)	.109 (2.77)	MS27488-16-2	Green
		M39029/106-616#	Blue	Brown	Blue					
12	12 & 14	M39029/56-353	Orange	Green	Orange	.188 (4.77)	.097 (2.46)	.142 (3.61)	MS27488-12-2	Yellow
		M39029/106-617#	Blue	Brown	Violet					
10	10 & 12	M39029/56-527	Green	Red	Violet	.355 (8.51)	.135 (3.42)	.162 (4.12)	M85049/81-10	Green
8	Coax* RG180B/U RG195A/U	M39029/59-366	Orange	Blue	Blue	Detailed instructions included with contacts	.135 (3.42)	.162 (4.12)	MS27488-8-3	Red
8	Twinax** M17/M176-0002	M39029/91-530	Green	Orange	Black		.124 (3.15)	.134 (3.40)	MS27488-8-3	Red
8 Power	8	10-497446-075	-	-	-	.470 (11.94)	.135 (3.42)	.162 (4.12)	MS27488-8-3	Red
8 Power	10	10-497446-095	-	-	-	.470 (11.94)	.135 (3.42)	.162 (4.12)	MS27488-8-3	Red
8 (Power-EU)	8	900-217	-	-	-	.393 (10.0)	.135 (3.42)	.162 (4.12)	MS27488-8-3	Red

#1500 Mating Cycle Contacts *Coax **Twinax call for details. For Fiber Optic Contacts, please call.

All dimensions in inches (millimeters in parenthesis)

PINS

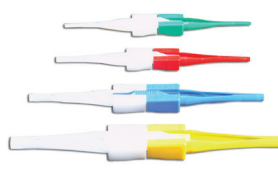

CONTACT SIZE	HAND-CRIMP TOOL	POWER-CRIMP TOOL	TURRET HEADS	USE LOCATOR COLOR	PLASTIC INSERTION/EXTRACTION TOOL	INSERTION TIP COLOR	EXTRACTION TIP COLOR	METAL INSERTION TOOL	COLOR BAND	METAL EXTRACTION TOOL	COLOR BAND	
											1	2
22D	M22520/2-01	WA22††	M22520/2-09	-	M81969/14-01	Green	White	MS27495A22M	Black	MS27495R22M	Black	White
20	M22520/1-01	WA27F††	M22520/1-04	Red	M81969/14-10	Red	Orange	MS27495A20	Red	MS27495R20	Red	White
16	M22520/1-01	WA27F††	M22520/1-04	Blue	M81969/14-03	Blue	White	MS27495A16	Blue	MS27495R16	Blue	White
12	M22520/1-01	WA27F††	M22520/1-04	Yellow	M81969/14-04	Yellow	White	DAK95-12B	-	DRK95-12B	-	-
10	TP-201423 or 1716P-1	-	-	-	M81969/14-05	Gray	White	M81969/8-11	Green	M81969/8-12	Green	White
8 Coax	M22520/2-01 M22520/5-01	WA22†† HX23	M22520/2-31 (inner) M22520/5-05 (outer)	-	M81969/14-12	Green		-	-	DRK264-8	-	-
8 Twinax	M22520/2-01 M22520/5-01	WA22 HX23	K709 (inner) Y631 (outer)	-	M81969/14-12	Green		M81969/46-06	Red	M81969/46-12	-	-
8 8 AWG Power	-	400B-1	414DA-8N (Die) 4691 (positioner)	-	M81969/14-12 (extraction only)	-	Green	-	-	DRK264-8	-	-
8 10 AWG Power	M3SP-6	400B-1	414DA-10N (Die) 4691 (positioner)	-	M81969/14-12 (extraction only)	-	Green	-	-	DRK264-8	-	-
8 (Power-EU)	809-872	-	809-873 (Die Set)	-	M81969/14-12 (extraction only)	-	Green	-	-	DRK264-8	-	-

†† Contact us for more tool accessories.

SOCKETS

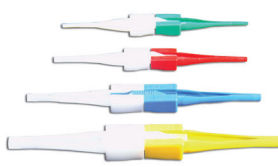

CONTACT SIZE	HAND-CRIMP TOOL	POWER-CRIMP TOOL	TURRET HEADS	USE LOCATOR COLOR	PLASTIC INSERTION/EXTRACTION TOOL	INSERTION TIP COLOR	EXTRACTION TIP COLOR	METAL INSERTION TOOL	COLOR BAND	METAL EXTRACTION TOOL	COLOR BAND	
											1	2
22D	M22520/2-01	WA22††	M22520/2-07	-	M81969/14-01	Green	White	MS27495A22M	Black	MS27495R22M	Black	White
20	M22520/1-01	WA27F††	M22520/1-04	Red	M81969/14-10	Red	Orange	MS27495A20	Red	MS27495R20	Red	White
16	M22520/1-01	WA27F††	M22520/1-04	Blue	M81969/14-03	Blue	White	MS27495A16	Blue	MS27495R16	Blue	White
12	M22520/1-01	WA27F††	M22520/1-04	Yellow	M81969/14-04	Yellow	White	DAK95-12B	-	DRK95-12B	-	-
10	TP-201423 or 1716P-1	-	-	-	M81969/14-05	Gray	White	M81969/8-11	Green	M81969/8-12	Green	White
8 Coax	M22520/2-01 M22520/5-01	WA22†† HX23	M22520/2-31 (inner) M22520/5-05 (outer)	-	M81969/14-12	Green		-	-	DRK264-8	-	-
8 Twinax	M22520/2-01 M22520/5-01	WA22 HX23	K709 (inner) Y631 (outer)	-	M81969/14-12	Green		M81969/46-06	Red	M81969/46-12	-	-
8 8 AWG Power	-	400B-1	414DA-8N (Die) 4691 (positioner)	-	M81969/14-12 (extraction only)	-	Green	-	-	DRK264-8	-	-
8 10 AWG Power	M3SP-6	400B-1	414DA-10N (Die) 4691 (positioner)	-	M81969/14-12 (extraction only)	-	Green	-	-	DRK264-8	-	-
8 (Power-EU)	809-872	-	809-873 (Die Set)	-	M81969/14-12 (extraction only)	-	Green	-	-	DRK264-8	-	-

†† Contact us for more tool accessories.

CONTACTS

COAX CONTACTS



M22520/5-01

Crimp Dies

COAX CONTACT SIZE	CABLE TYPE	CONTACT PART NUMBER		CRIMPING TOOLS	
		PIN	SOCKET	INNER CONTACT	CRIMP FERRULE
16	RG-178B/U, RG-196A/U	21-033122-564 (M39029/76-425)	21-033123-564 (M39029/77-429)	M22520/2-01 w/ Positioner M22522/2-35 or w/ Daniels Positioner K532	M22520/4-01 w/ Positioner M22520/4-02
	RG-174A/U, RG-188A/U, RG-161/U, RG-187A/U, RG-316/U, RG-179B/U	21-033122-563 (M39029/76-424)	21-033123-563 (M39029/77-428)		
12	RG-180B/U, RG-195A/U	21-033122-546 (M39029/28-211)	21-033123-546 (M39029/75-416)	M22520/2-01 w/ Positioner M22520/2-34 or w/ Daniels Positioner K323	M22520/31-01 w/ Positioner M22520/31-02 or Daniels GS-200 Tool w/ Positioner G2P330
		21-033122-541 (M39029/28-409)	21-033123-541 (M39029/75-417)		
8	RG-187A/U, RG-179B/U, RG-174A/U, RG-188A/U, RG-316/U, RG-161/U	21-033102-023	21-033101-023	M22520/2-01 w/ Positioner M22520/2-31 or Solder	M22520/5-01 w/ die set M22520/5-03 (A) or M22520/5-08 (A) M22520/5-35 (B) or M22520/10-01 w/ die set M22520/10-05 (A)
	RG-142B/U, RG-223/U	21-033102-024	21-033101-024		M22520/5-01 w/ die set M22520/5-05 (A) or M22520/5-19 (B) or M22520/10-01 w/ die set M22520/10-07 (A)
	RG-180B/U, RG-195A/U	21-033102-021 (M39029/60-367)	21-033101-021 (M39029/59-366)		M22520/5-01 w/ die set M22520/5-05 (B) or M22520/5-41 (B) or M22520/10-01 w/ die set M22520/10-07 (B)
	RG-400	21-033102-027	21-033101-027	M22520/2-01 w/ Positioner M22520/2-10	M22520/5-01 w/ die set M22520/5-45 (A)
	RG-58 (M17/155-00001)	21-033102-029	21-033101-029	Solder	M22520/5-01 w/ die set M22520/5-05 (B)

PRINTED CIRCUIT BOARD CONTACTS - PIN

PCB PIN CONTACTS	SIZE	TAIL DIAMETER +/- .001	CONTACT STICKOUT MAX./MIN.				
			D38999/20 TVP00	TVP02	D38999/26 TV06	D38999/24 TV07	
						METAL	COMPOSITE
10-407552-015	22D	0.019	.335 / .280	.555 / .500	.360 / .305	.329 / .279	.286 / .236
10-407552-055	22D	0.019	.224 / .169	.444 / .389	.249 / .194	.218 / .168	.175 / .125
10-407552-085	22D	0.019	.060 / .010	.280 / .230	.085 / .035	.054 / .009	.011 / NS
10-407552-115	22D	0.019	.002 / NS	.222 / NS	.023 / NS	NS	NS
10-497640-015	20	0.019	.348 / .298	.568 / .518	.373 / .323	.342 / .297	.299 / .254
10-497640-025	20	0.019	.213 / .163	.433 / .383	.238 / .188	.207 / .162	.164 / .119
10-497640-045	20	0.019	NS	NS	NS	NS	NS
10-497596-015	20	0.025	.058 / .012	.278 / .232	.083 / .037	.052 / .011	.009 / .044
10-497596-025	20	0.025	.148 / .102	.368 / .322	.173 / .127	.142 / .101	.099 / .058
10-497596-035	20	0.025	.229 / .183	.449 / .403	.254 / .208	.223 / .182	.180 / .058
10-497596-055	20	0.025	.346 / .300	.566 / .520	.371 / .325	.340 / .299	.297 / .256
10-497695-015	16	0.040	.255 / .205	.475 / .425	.280 / .230	.249 / .204	.206 / .161
10-497630-035	16	0.062	.060 / .010	.280 / .230	.085 / .035	.054 / .009	.011 / NS
10-497630-055	16	0.062	.228 / .178	.460 / .375	.253 / .203	.244 / .177	.201 / .190
10-597502-015	12	0.081	.228 / .178	.448 / .398	.252 / .203	.222 / .177	.179 / .134

Standard PC tail used

All dimensions in inches (millimeters in parenthesis)

CONTACTS

INSERTION/EXTRACTION TOOLS

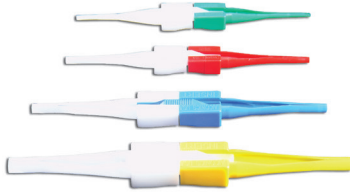

WIRE STRIP LENGTH

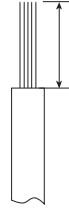

WIRE SEALING RANGE



INSTALLATION TOOLS		WIRE STRIP LENGTHS	WIRE SEALING RANGE	
INSERTION	REMOVAL		MIN.	MAX.
M81969/8-07 or M81969/14-03	M81969/8-08 or M81969/14-03	Contact us for details	.065 (1.65)	.109 (2.77)
M81969/8-09 or M81969/14-04	M81969/8-10 or M81969/14-04	Contact us for details	.097 (2.46)	.142 (3.61)
Hand insertion	M81969/14-012 or DRK264-8 or 11-9170	Contact us for details	.135 (3.43)	.155 (3.94)

PRINTED CIRCUIT BOARD CONTACTS - SOCKET

PCB PIN CONTACTS	SIZE	TAIL DIAMETER +/- .001	CONTACT STICKOUT MAX./MIN.					
			D38999/20 TVP00		D38999/26 TV06	D38999/24 TV07		
						METAL	COMPOSITE	
10-597878-011	22D	0.019	.291 / .226	.511 / .446	.316 / .251	.285 / .222	.242 / .182	
10-597878-331	22D	0.019	.242 / .181	.471 / .399	.267 / .202	.258 / .180	.215 / .155	
10-497623-025	22D	0.019	.868 / .803	1.088 / 1.023	.893 / .828	.862 / .802	.819 / .759	
10-497623-035	22D	0.019	.348 / .283	.568 / .503	.373 / .308	.342 / .282	.299 / .239	
10-597878-031	22D	0.019	.208 / .143	.428 / .363	.233 / .168	.202 / .142	.159 / .099	
10-597878-071	22D	0.019	.146 / .081	.366 / .301	.171 / .106	.140 / .080	.097 / .037	
10-497623-145	22D	0.019	.609 / .539	.829 / .759	.634 / .564	.603 / .538	.560 / .495	
10-597878-151	22D	0.019	.423 / .358	.643 / .578	.448 / .383	.417 / .357	.374 / .314	
10-497643-015	20	0.019	.348 / .294	.568 / .514	.373 / .319	.342 / .293	.299 / .250	
10-497643-025	20	0.019	.213 / .159	.433 / .379	.238 / .184	.207 / .158	.164 / .115	
10-597878-031	20	0.019	.555 / .501	.775 / .721	.580 / .526	.549 / .500	.506 / .457	
10-497650-015	16	0.040	.255 / .201	.475 / .421	.280 / .226	.249 / .200	.206 / .157	
10-597503-015	12	0.081	.184 / .130	.404 / .350	.209 / .155	.178 / .129	.135 / .086	

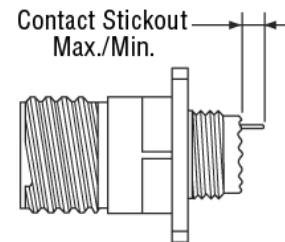

= Standard PC tail used

All dimensions in inches (millimeters in parenthesis)

QUADRAX CONTACTS



Cable Part Number	Contact Part Number		Inner Impedance	Conductor (AWG)	Electrical Protocol
	Pin	Socket			
Draka Fileca F-4703-3, F4704-4, Filotex ET 2PC236, FilotexET2PF870, PIC Wire E50424ABS0972, Tensolite23450/04090X-4(LD)	21-033384-021	21-033385-021	100Ω	24	Ethernet, 1000Base-T Gigabit Ethernet
Tensolite 26473/02006X-4(LD)/Gore RCN8328 (not for new designs, use 21-033450/1 series)	21-033384-031	21-033385-031	150Ω	26	-
Tensolite NF24Q100, NF24Q100-0, 24443/9P025X-4(LD), S280W502-4, 24443/03130X-4(LD), 24443/C20714X-4(LD), 24450/0120X-4(LD), NF24-2Q100, TYCO CECRWC-18664, GORE GSC-01-81869-01, 24443/03166X-4(LD), ThermaxT956-4T200, Pic Wire E51424, Thermax MX100Q-24, NF24Q100-01-200C (Space), PIC E50424	21-033384-051	21-033385-051	100Ω	24	Ethernet, 1000Base-T Gigabit Ethernet
Tensolite NF22Q100, NF22Q100-01, Thermax 956-5, Draka FilecaF-4704-5, GORE RCN 7688, ABS1503 KD 24	21-033384-061	21-033385-061	100Ω	22	
Tensolite NF26Q100, NF26Q100-01, NF26-2Q100, PIC E50426	21-033384-071	21-033385-071	100Ω	26	Ethernet (100 Mbps), 1000 Base-T Gigabit Ethernet (1 Gbps)
JSFY02-1	21-033384-091	21-033385-091	110Ω	24	
Gore RCN8487, JSFY18	21-033384-111	21-033385-111	110Ω	24	
Draka Fileca F-4704-6, Gore RCN 8672	21-033384-151	21-033385-151	100Ω	26	
Tensolite NF24Q100-01 (same as 21-03338()-051, uses EMI Piggyback)	21-033384-161	21-033385-161	100Ω	24	
Gore RCN8513, JSF-118-3	21-033384-171	21-033385-171	100Ω	22	
Tensolite NF24Q100, NF24Q100-01 for 2.5 Gbps applications	21-033384-191	21-033385-191	100Ω	24	Serial FPDP Applications (2.5 Gbps)
USB2 (28433/02171LX-4)	21-033384-101	21-033385-101	95Ω		USB2.0 (480 Mbps)
Tensolite 24450/03089X-4(LD)	21-033384-211	21-033385-211	110Ω	24	IEEE 1394B Firewire
JSFY02-1, JSFY18	21-033384-221	21-033385-221	110Ω	24	Contact us for details
Gore RCN8487, JSFY18	21-033384-231	21-033385-231	110Ω	24	
Tensolite 24450/03089X-4(LD) Same as 21-03338()-211 but Box pattern, mates with 21-03338()-241 only	21-033384-241	21-033385-241	110Ω	24	

PCB types and transitions are available, please contact us.



Crimping Tools



M22520/5-01

Crimp Dies



Plastic



Metal

Installation Instruction Sheet	Inner Crimp Tool		Outer Crimp Tool		Plastic Sealing Plug	Metal Sealing Plug*	Metalized Piggyback Grommet
	Tool (setting)	Positioner	Tool	Die Set (location)			
L-2119-A	M22520/2-01 (5)	Daniels K709 (M22520/2-37)	M22520/5-01	M22520/5-45 (A)	T3-4008-59P	21-033899-8Q1	21-033321-023
L-2119-B	M22520/2-01 (4)		M22520/5-01	M22520/5-45 (A)	T3-4008-59P	21-033899-8Q1	21-033321-023
L-2119-D	M22520/2-01 (5)		M22520/5-01	M22520/5-45 (A)	T3-4008-59P	21-033899-8Q1	21-033321-023
L-2119-H	M22520/2-01 (5)		M22520/5-01	M22520/5-45 (A)	T3-4008-59P	21-033899-8Q1	21-033321-023
L-2119-AB	M22520/2-01 (5)		M22520/5-01	M22520/5-45 (A)	T3-4008-59P	21-033899-8Q1	21-033321-023
L-2119-AD	M22520/2-01 (5)		M22520/5-01	M22520/5-45 (A)	T3-4008-59P	21-033899-8Q1	21-033321-023
L-2119-AK	M22520/2-01 (4)		M22520/5-01	M22520/5-45 (A)	T3-4008-59P	21-033899-8Q1	21-033321-023
L-2119-AW	M22520/2-01 (4)		M22520/5-01	M22520/5-45(A)	T3-4008-59P	21-033899-8Q1	21-033321-023
L-2119-BE							
L-2119-BN	M22520/2-01 (5)		M22520/5-01	M22520/5-45 (A)	T3-4008-59P	21-033899-8Q1	21-033321-023
L-2119-BS	M22520/2-01 (5)	M22520/5-01	M22520/5-45 (A)	T3-4008-59P	21-033899-8Q1	21-033321-023	
Contact us for details							
Contact us for details							
L-2119-CD	M22520/2-01 (5)	Daniels K709 (M22520/2-37)	M22520/5-01	M22520/5-45 (A)	T3-4008-59P	21-033899-8Q1	21-033321-023
L-2119-CR	M22520/2-01 (4)		M22520/5-01	M22520/5-45 (A)	T3-4008-59P	21-033899-8Q1	21-033321-023

Contact us for details

*Can be used when mating with contacts on mating half.

DIMENSIONS

RECEPTACLES

TVP00R/TVPS00R
CTVP00R/CTVPS00R
D38999/20

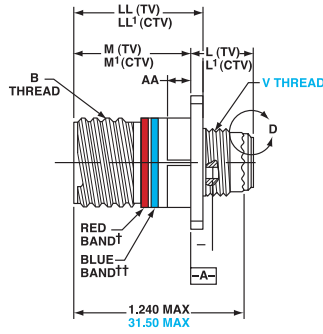

TVP02R/TVPS02R
CTVP02R/CTVPS02R

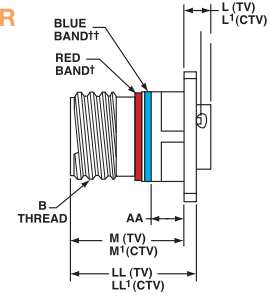

SHELL SIZE	MS SHELL CODE	B THREAD CLASS 2A 1.0P-0.3L	M +.000/-0.005 (+.000/-.130) TV	M1 +.000/-0.005 (+.000/-.130) CTV	Z MAX. (TV)	Z1 Max. (CTV)	L MAX. (TV)		L1 MAX. (CTV)		LL +.006/-.000 (+.150/-.000) TV	LL1 ±.005/ (±.130) CTV	AA MAX PANEL THICKNESS
							D38999/20 /TVP02R / TVP01R	TVP02R	D38999/20 / CTVP00R / CTVP01R	CTVP02R			
9	A	0.625	.820 (20.83)	.773 (19.63)	.153 (3.89)	.198 (5.03)	.469 (11.91)	.205 (5.21)	.514 (13.06)	.250 (6.35)	.905 (22.99)	.908 (23.06)	.234 (5.94)
11	B	0.75	.820 (20.83)	.773 (19.63)	.153 (3.89)	.198 (5.03)	.469 (11.91)	.205 (5.21)	.514 (13.06)	.250 (6.35)	.905 (22.99)	.908 (23.06)	.234 (5.94)
13	C	0.875	.820 (20.83)	.773 (19.63)	.153 (3.89)	.198 (5.03)	.469 (11.91)	.205 (5.21)	.514 (13.06)	.250 (6.35)	.905 (22.99)	.908 (23.06)	.234 (5.94)
15	D	1	.820 (20.83)	.773 (19.63)	.153 (3.89)	.198 (5.03)	.469 (11.91)	.205 (5.21)	.514 (13.06)	.250 (6.35)	.905 (22.99)	.908 (23.06)	.234 (5.94)
17	E	1.188	.820 (20.83)	.773 (19.63)	.153 (3.89)	.198 (5.03)	.469 (11.91)	.205 (5.21)	.514 (13.06)	.250 (6.35)	.905 (22.99)	.908 (23.06)	.234 (5.94)
19	F	1.25	.820 (20.83)	.773 (19.63)	.153 (3.89)	.198 (5.03)	.469 (11.91)	.205 (5.21)	.514 (13.06)	.250 (6.35)	.905 (22.99)	.908 (23.06)	.234 (5.94)
21	G	1.375	.790 (20.07)	.741 (18.82)	.183 (4.65)	.228 (5.79)	.500 (12.70)	.235 (5.97)	.545 (13.84)	.280 (7.11)	.905 (22.99)	.904 (22.96)	.204 (5.18)
23	H	1.5	.790 (20.07)	.741 (18.82)	.183 (4.65)	.228 (5.79)	.500 (12.70)	.235 (5.97)	.545 (13.84)	.280 (7.11)	.905 (22.99)	.904 (22.96)	.204 (5.18)
25	J	1.625	.790 (20.07)	.741 (18.82)	.183 (4.65)	.228 (5.79)	.500 (12.70)	.235 (5.97)	.545 (13.84)	.280 (7.11)	.905 (22.99)	.904 (22.96)	.204 (5.18)

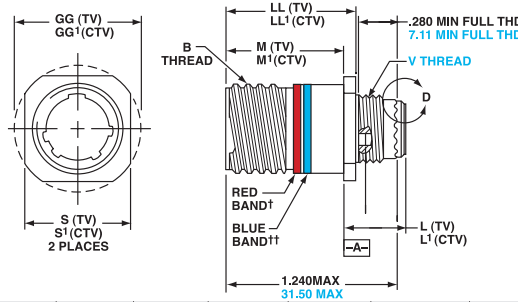

Shell Size	MS Shell Size Code	B Thread Class 2A 0.1P-0.3L-TS (Plated)	M +.000/-0.005 (+.000/-.130) TV	M1 +.000/-0.005 (+.000/-.130) CTV	Z Max. (TV)	Z1 Max. (CTV)	L Max. (TV)	L1 Max. (CTV)	LL +.006/-0.000 (+.150/-.000) TV	LL1 ±.005 (±.130) CTV	S ±.010 (±.250) TV	S1 ±.010 (±.250) CTV	GG ±.010 (±.250) TV	GG1 ±.010 (±.250) CTV	V Thread Metric
9	A	0.625	.820 (20.83)	.773 (19.63)	.153 (3.89)	.198 (5.03)	.469 (11.91)	.514 (13.06)	.905 (22.99)	.908 (23.06)	.675 (17.15)	.635 (16.13)	.812 (20.62)	.699 (17.75)	M12X1-6g
11	B	0.750	.820 (20.83)	.773 (19.63)	.153 (3.89)	.198 (5.03)	.469 (11.91)	.514 (13.06)	.905 (22.99)	.908 (23.06)	.800 (20.32)	.765 (19.43)	.905 (22.99)	.875 (22.22)	M15X1-6g
13	C	0.875	.820 (20.83)	.773 (19.63)	.153 (3.89)	.198 (5.03)	.469 (11.91)	.514 (13.06)	.905 (22.99)	.908 (23.06)	.925 (23.50)	.885 (22.47)	1.093 (27.76)	1.007 (25.57)	M18X1-6g
15	D	1.000	.820 (20.83)	.773 (19.63)	.153 (3.89)	.198 (5.03)	.469 (11.91)	.514 (13.06)	.905 (22.99)	.908 (23.06)	1.050 (26.67)	1.100 (27.94)	1.219 (30.96)	1.140 (28.95)	M22X1-6g
17	E	1.1875	.820 (20.83)	.773 (19.63)	.153 (3.89)	.198 (5.03)	.469 (11.91)	.514 (13.06)	.905 (22.99)	.908 (23.06)	1.238 (31.45)	1.197 (30.40)	1.375 (34.93)	1.229 (31.21)	M25X1-6g
19	F	1.250	.820 (20.83)	.773 (19.63)	.153 (3.89)	.198 (5.03)	.469 (11.91)	.514 (13.06)	.905 (22.99)	.908 (23.06)	1.300 (33.02)	1.260 (32.00)	1.469 (37.31)	1.380 (35.05)	M28X1-6g
21	G	1.375	.790 (20.07)	.741 (18.92)	.183 (4.65)	.228 (5.79)	.500 (12.70)	.545 (13.84)	.905 (22.99)	.904 (22.96)	1.425 (36.20)	1.385 (35.18)	1.625 (41.28)	1.493 (37.92)	M31X1-6g
23	H	1.500	.790 (20.07)	.741 (18.92)	.183 (4.65)	.228 (5.79)	.500 (12.70)	.545 (13.84)	.905 (22.99)	.904 (22.96)	1.550 (39.37)	1.510 (38.35)	1.750 (44.45)	1.626 (41.30)	M34X1-6g
25	J	1.625	.790 (20.07)	.741 (18.92)	.183 (4.65)	.228 (5.79)	.500 (12.70)	.545 (13.84)	.905 (22.99)	.904 (22.96)	1.675 (42.55)	1.635 (41.53)	1.875 (47.63)	1.777 (45.13)	M37X1-6g

All dimensions in inches (millimeters in parenthesis)

RECEPTACLES

TVP00R/TVPS00R
 CTPV00R/CTVPS00R
 TVP02R/TVPS02R
 CTPV02R/CTVPS02R
 D38999/20 (CONTINUED)

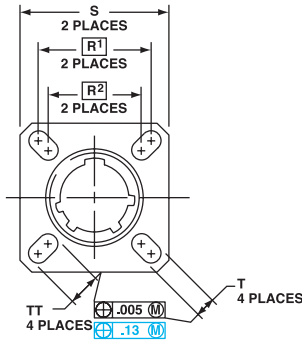

R1	R2	S Max.	T +.008/- .006 (+.200/- .130)	TT +.008/- .006 (+.200/- .130)	V Thread Metric
.719 (18.26)	.594 (15.09)	.948 (24.10)	.128 (3.25)	.216 (5.49)	M12X1-6g
.812 (20.62)	.719 (18.26)	1.043 (26.50)	.128 (3.25)	.194 (4.93)	M15X1-6g
.906 (23.01)	.812 (20.62)	1.137 (28.90)	.128 (3.25)	.194 (4.93)	M18X1-6g
.969 (24.61)	.906 (23.01)	1.232 (31.30)	.128 (3.25)	.173 (4.39)	M22X1-6g
1.062 (26.97)	.969 (24.61)	1.323 (33.70)	.128 (3.25)	.194 (4.93)	M25X1-6g
1.156 (29.36)	1.062 (26.97)	1.449 (36.90)	.128 (3.25)	.194 (4.93)	M28X1-6g
1.250 (31.75)	1.156 (29.36)	1.575 (40.10)	.128 (3.25)	.194 (4.93)	M31X1-6g
1.375 (34.92)	1.250 (31.75)	1.701 (43.30)	.154 (3.91)	.242 (6.15)	M34X1-6g
1.500 (38.10)	1.375 (34.92)	1.823 (46.40)	.154 (3.91)	.242 (6.15)	M37X1-6g

TV07R/TVS07R
 CTV02R/CTVS07R
 D38999/24

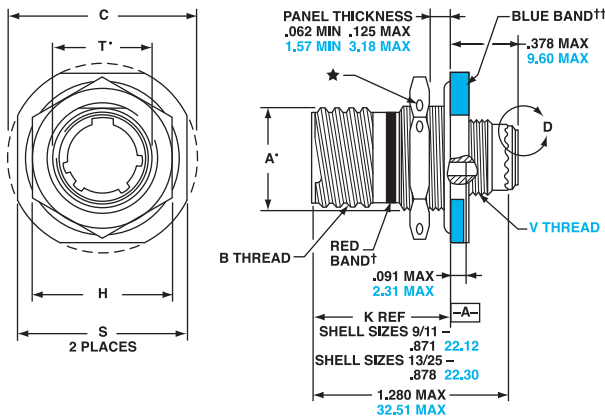

Shell Size		A*	B Thread	C Max.	D1	D2	HHex	S	T*	V
TV07/CTV07 D38999/24		+ .000/- .010 (+.000/- .250)	Class 2A 0.1P- 0.3L-TS (Plated)	Flange Wrench	+ .010/- .000 (+.250/- .000)	+ .010/- .000 (+.250/- .000)	+ .017/- .016 (+.430/- .410)	± .010	+ .010/- .000 (+.250/- .000)	Thread Metric
9	A	0.669 (16.99)	0.6250	1.199 (30.45)	.700 (17.78)	.670 (17.02)	.875 (22.23)	1.062 (26.97)	.697 (17.70)	M12X1-6g
11	B	0.769 (19.53)	0.7500	1.386 (35.20)	.825 (20.96)	.770 (19.59)	1.000 (25.40)	1.250 (31.75)	.822 (20.88)	M15X1-6g
13	C	0.955 (24.26)	0.8750	1.511 (38.38)	1.010 (25.65)	.955 (24.26)	1.188 (30.18)	1.375 (34.93)	1.007 (25.58)	M18X1-6g
15	D	1.084 (27.53)	1.0000	1.636 (41.55)	1.135 (28.83)	1.085 (27.56)	1.312 (33.32)	1.500 (38.10)	1.134 (28.80)	M22X1-6g
17	E	1.208 (30.68)	1.1875	1.761 (44.73)	1.260 (32.01)	1.210 (30.73)	1.438 (36.53)	1.625 (41.28)	1.259 (31.98)	M25X1-6g
19	F	1.333 (33.86)	1.2500	1.949 (49.50)	1.385 (35.18)	1.335 (33.91)	1.562 (39.67)	1.812 (46.02)	1.384 (35.15)	M28X1-6g
21	G	1.459 (37.06)	1.3750	2.073 (52.65)	1.510 (38.35)	1.460 (37.08)	1.688 (42.80)	1.938 (49.23)	1.507 (38.28)	M31X1-6g
23	H	1.575 (40.01)	1.5000	2.199 (55.85)	1.635 (41.53)	1.585 (40.26)	1.812 (46.02)	2.062 (52.37)	1.634 (41.50)	M34X1-6g
25	J	1.709 (43.41)	1.6250	2.323 (59.00)	1.760 (44.70)	1.710 (43.43)	2.000 (50.80)	2.188 (55.58)	1.759 (44.68)	M37X1-6G

All dimensions in inches (millimeters in parenthesis)

DIMENSIONS

PLUGS

TV06R/TVS06R
CTV06R/CTVS06R
D38999/26

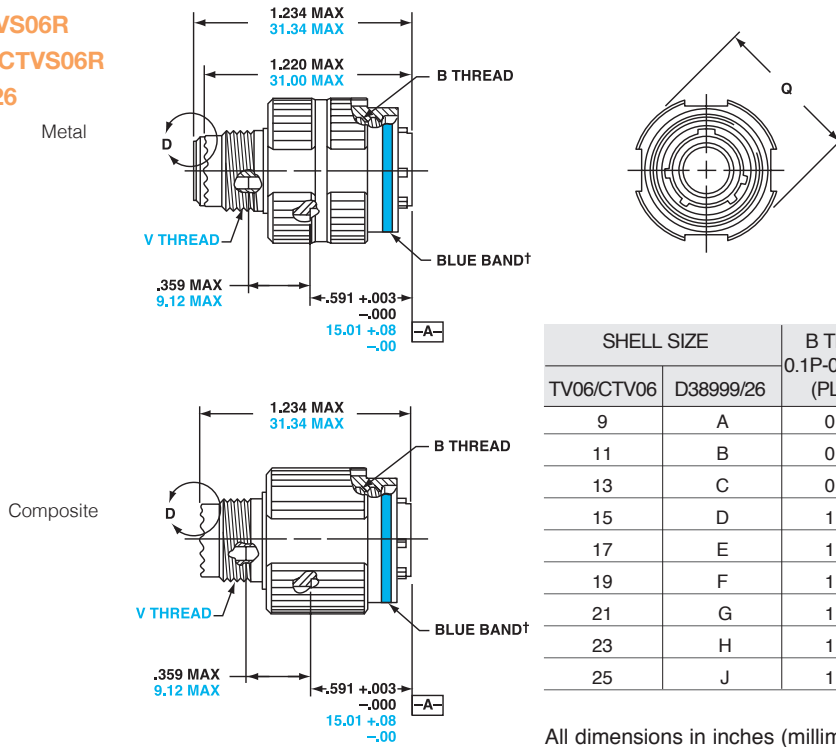

SHELL SIZE		B THREAD	Q	V
TV06/CTV06	D38999/26	0.1P-0.3L-TS-2B (PLATED)	DIAMETER MAX.	THREAD METRIC
9	A	0.6250	.858 (21.80)	M12X1-6g
11	B	0.7500	.984 (25.00)	M15X1-6g
13	C	0.8750	1.157 (29.40)	M18X1-6g
15	D	1.0000	1.280 (32.50)	M22X1-6g
17	E	1.1875	1.406 (35.70)	M25X1-6g
19	F	1.2500	1.516 (38.50)	M28X1-6g
21	G	1.3750	1.642 (41.70)	M31X1-6g
23	H	1.5000	1.768 (44.90)	M34X1-6g
25	J	1.6250	1.890 (48.00)	M37X1-6G

All dimensions in inches (millimeters in parenthesis)

PANEL CUTOUTS

WALL MOUNT RECEPTACLE

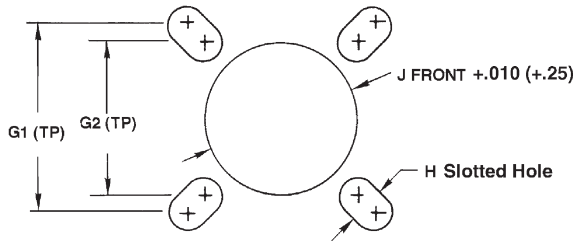

JAM NUT RECEPTACLE

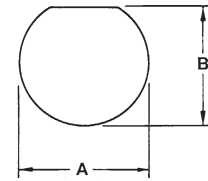

Shell Size		D38999/20 & TV/CTV Wall Mount				
D38999	TV/CTV	G1	G2	H Diameter +.005 (+.130) -.000 (.000)	Front Mount J Min.	Back Mount J Min.
A	9	.719 (18.26)	.59 (15.09)	.130 (3.25)	.516 (13.11)	.656 (16.66)
B	11	.81 (20.62)	.71 (18.26)	.130 (3.25)	.625 (15.88)	.796 (20.22)
C	13	.91 (23.01)	.81 (20.62)	.130 (3.25)	.750 (19.05)	.922 (23.42)
D	15	.97 (24.61)	.90 (23.01)	.130 (3.25)	.906 (23.01)	1.047 (26.59)
E	17	1.06 (26.97)	.96 (24.61)	.130 (3.25)	1.016 (25.81)	1.219 (30.96)
F	19	1.16 (29.36)	1.06 (26.97)	.130 (3.25)	1.141 (28.98)	1.297 (32.94)
G	21	1.25 (31.75)	1.15 (29.36)	.130 (3.25)	1.266 (32.16)	1.422 (36.12)
H	23	1.38 (34.93)	1.25 (31.75)	.155 (3.94)	1.375 (34.93)	1.547 (39.29)
J	25	1.50 (38.10)	1.37 (34.93)	.155 (3.94)	1.484 (37.69)	1.672 (42.47)

D38999/24 & TV/CTV Jam Nut	
A	B
+0.010 (+.025) -.000 (.000)	+0.000 (000) -.010 (-.025)
.693 (17.60)	.657 (16.70)
.825 (20.96)	.770 (19.59)
1.010 (25.65)	.955 (24.26)
1.135 (28.83)	1.085 (27.56)
1.260 (32.01)	1.210 (30.73)
1.385 (35.18)	1.335 (33.91)
1.510 (38.35)	1.460 (37.08)
1.635 (41.53)	1.585 (40.29)
1.760 (44.70)	1.710 (43.43)

All dimensions in inches (millimeters in parenthesis)

PANEL THICKNESS

WALL MOUNT RECEPTACLE

D38999/20 Rear Mount .125" (3.18) Max.

JAM NUT RECEPTACLE

D38999/24 Jam Nut
 .125" (3.18) Max./0.062" (1.57) Min.

CONNECTOR TOOLS

TG70 STRAP WRENCH

The strap wrench is used to connect or disconnect coupling nuts in a confined space, or to tighten or loosen endbells without damaging the connector plating. A strap wrench also increases torque, allowing you to more easily mate or unmate a connector pair.

Substitute tools, such as a pipe wrench or pliers, should never be used because of the high probability of severe damage to the connector plating or the coupling mechanism.



TG69P NON-MARRING ADJUSTABLE ENDBELL PLIERS FOR FIELD SERVICE

The TG69P pliers have resilient jaws and are used to tighten or remove endbells without damaging the connector plating. The pliers are adjustable and will accommodate all of the connector sizes in this catalog. Substitute tools, such as a pipe wrench or metal jaw pliers, should never be used due to the high probability of severe damage to the connector plating. Replacement jaws, part number G77015, are available.



600 SERIES PRODUCTION SYSTEM

The 600 series is a complete system for the proper assembly and torquing of connector endbells. The system includes a bench-mounted or hand-held torque wrench, plug and receptacle holders, and a range of endbell tightening tools. When used together, these tools provide the user with consistent endbell installations. Each item is shipped with detailed assembly instructions.



600-007
Bench-mounted torque wrench

600-004
Hand-held torque wrench

PLUG AND RECEPTACLE HOLDERS

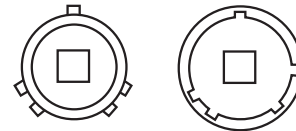

600H005-R# 600H005-P#

PINS WITH ALTERNATE KEYING	SOCKETS WITH ALTERNATE KEYING
PA = E	SA = F
PB = R	SB = T
PC = W	SC = X
PD = Y	SD = Z

MIL-DTL-38999 SERIES III FOR TV-CTV		
SHELL SIZE	RECEPTACLES	PLUGS
A 9	600H005-9R#	600H005-9P#
B 11	600H005-11R#	600H005-11P#
C 13	600H005-13R#	600H005-13P#
D 15	600H005-15R#	600H005-15P#
E 17	600H005-17R#	600H005-17P#
F 19	600H005-19R#	600H005-19P#
G 21	600H005-21R#	600H005-21P#
H 23	600H005-23R#	600H005-23P#
J 25	600H005-25R#	600H005-25P#

Add polarizations: N, A, B, C, D, E

DUMMY RECEPTACLES, DUST CAPS & PLUG CAPS



10-553974-XX†



10-552943-XX†



10-553970-XX† = 6" chain
10-553120-XX† = 3.5" chain



10-552944-XX† = 5" chain w/ loop
10-553998-XX† = 3.5" chain w/ loop

D38999	TV/CTV	DUMMY RECEPTACLES	RECEPTACLE DUST CAPS		PLUG CAP
			FOR FLANGED	FOR JAM NUT	
A	9	D38999/22A**	D38999/33**9R	D38999/33**9N	D38999/32**9##
B	11	D38999/22B**	D38999/33**11R	D38999/33**11N	D38999/32**11##
C	13	D38999/22C**	D38999/33**13R	D38999/33**13N	D38999/32**13##
D	15	D38999/22D**	D38999/33**15R	D38999/33**15N	D38999/32**15##
E	17	D38999/22E**	D38999/33**17R	D38999/33**17N	D38999/32**17##
F	19	D38999/22F**	D38999/33**19R	D38999/33**19N	D38999/32**19##
G	21	D38999/22G**	D38999/33**21R	D38999/33**21N	D38999/32**21##
H	23	D38999/22H**	D38999/33**23R	D38999/33**23N	D38999/32**23##
J	25	D38999/22J**	D38999/33**25R	D38999/33**25N	D38999/32**25##

Olive drab chromate over cadmium over nickel (500-hour salt spray)

= Select code for ring or loop

N = Ring to attach to backshell

R = Loop for screw mounting

XX = Shell size

** Plating Material

W = Olive drab chromate over cadmium over nickel (1000-hour salt spray)

F = Electroless nickel (Fluid-resistant)

K = Stainless steel

Finish	10-No Suffix
Olive Drab, Cadmium, Nickel Base	-XX9
Electroless Nickel	-XXG

† Select code for plating

CABLE CLAMPS



Straight



Right Angle

D38999	TV/CTV	LOW-COST	SELF-LOCKING	LOW-COST	SELF-LOCKING	CABLE RANGE	
						MIN.	MAX.
A	9	M85049/38-9**	M85049/38S9**	M85049/39-9**	M85049/39S9**	.098 (2.49)	.234 (5.94)
B	11	M85049/38-11**	M85049/38S11**	M85049/39-11**	M85049/39S11**	.153 (3.89)	.234 (5.94)
C	13	M85049/38-13**	M85049/38S13**	M85049/39-13**	M85049/39S13**	.190 (4.83)	.328 (8.33)
D	15	M85049/38-15**	M85049/38S15**	M85049/39-15**	M85049/39S15**	.260 (6.60)	.457 (11.61)
E	17	M85049/38-17**	M85049/38S17**	M85049/39-17**	M85049/39S17**	.283 (7.19)	.614 (15.60)
F	19	M85049/38-19**	M85049/38S19**	M85049/39-19**	M85049/39S19**	.325 (8.25)	.634 (16.10)
G	21	M85049/38-21**	M85049/38S21**	M85049/39-21**	M85049/39S21**	.343 (8.71)	.698 (17.73)
H	23	M85049/38-23**	M85049/38S23**	M85049/39-23**	M85049/39S23**	.381 (9.68)	.823 (20.90)
J	25	M85049/38-25**	M85049/38S25**	M85049/39-25**	M85049/39S25**	.418 (10.62)	.853 (21.67)

** Plating Material

W = Olive drab chromate over cadmium over nickel (1000-hour salt spray)







N = Electroless nickel (Fluid-resistant)

A = Black anodize

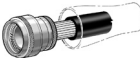
S = Stainless steel

All dimensions in inches (millimeters in parenthesis)

STANDARD MIL-SPEC ACCESSORIES

	SEALED	EMI/RFI	ORIENTATION S = STRAIGHT A = 90° B = 45°	ENDBELL TYPE	DESCRIPTION
 M85049/69	Y	N	S	Heat Shrink Boot Adapters	Designed for use with straight or right angle shrink boots. A knurled rear section with a boot groove provides excellent surface for the boot to grab the metal endbell. Available with lock wire and drain holes. See Heat Shrink Boots on pages 491-492 .
 M85049/21	N	N	S	Extender Backshell	Non-environmental, designed for use with jacketed cable, allows extra space to break out the wires and still provide strain relief clamping to the outside of the cable jacket.
 M85049/18	Y	Y	S	Extender Backshell	This EMI/RFI-shielding, environmentally-sealed endbell features a standard-style cable clamp with gland seal at the end of and extender-style backshell.
 M85049/19	N	Y	S	Extender Backshell	This EMI/RFI-shielding, non-environmentally-sealed endbell features a standard-style cable clamp.
 M85049/88 M85049/89 M85049/90	Y	Y	S B A	Banding Adapter	Banding adapters utilize a band of metal that fastens and grounds cable shields to the outside of endbells. This method of terminating shields has advantages in that they typically use tools to tighten and trim the bands. These tools make the termination tight, repeatable, reworkable (if you make a mistake, just cut the band off and start again) and facilitates service. Banding adapters help lower the total applied cost by having simpler designs that have fewer parts with uncomplicated assembly procedures.
 M85049/14S	N	N	S	E-Nut	Wire seal compression nut.

LOW-COST UNIVERSAL ENDBELLS



POTTED (PREFERRED)

- U** = Unshielded
- US** = with EMI-shielding spring
- UT** = with EMI-shielding tape



Spring



Mesh Tape



CG = Cord Grips



Right Angle



CA = Flexible Conduit Adapter



Q = Quick Thread Converter
For use with Standard Accessoried Thread
MS3057

(Use when needed)

EXCERPT FROM MIL-DTL-38999K

3.43.2 JAN brand. The United States Government has adopted, and is exercising legitimate control over the certification marks "JAN" and "J", respectively, to indicate that items so marked or identified are manufactured to, and meet all the requirements of military specification. Accordingly, items acquired to, and meeting all of the criteria specified herein and in applicable specifications shall bear the certification mark "JAN" except that items too small to bear the certification mark "JAN" shall bear the letter "J". The "JAN" or "J" shall be placed immediately before the PIN except that if such location would place a hardship on the manufacturer in connection with such marking, the "JAN" or "J" may be located on the first line above or below the PIN. Items furnished under contracts or orders which either permit or require deviation from the conditions or requirements specified herein or in applicable specifications shall not bear "JAN" or "J". In the event an item fails to meet the requirements of this specification and the applicable specification sheets or associated detail specifications, the manufacturer shall remove the "JAN" or the "J" from the sample tested and also from all items represented by the sample. The "JAN" or "J" certification mark shall not be used on products acquired to contractor drawings or specification. The United States Government has obtained Certificate of Registration No. 504,860 for the certification mark "JAN".

Note: The "JAN" or "J" is not part of the PIN but indicates a certification.

ASSEMBLY INSTRUCTIONS

WIRE STRIPPING

Strip insulation from end of wire to be crimped. (See table for proper stripping dimensions.) Do not cut or damage wire strands.

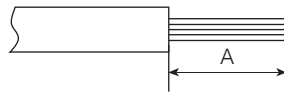

WIRE SIZE	A
22, 22M, 22D	.125 (3.18)
20	.188 (4.77)
16	.188 (4.77)
12	.188 (4.77)
10	.335 (8.51)
8 (power)	.470 (11.99)

CONTACT CRIMPING

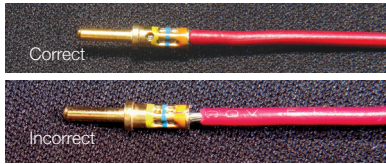

STEP 1: Insert wire into rear of contact. Wire insulation must press against rear of contact. Wire must be visible through inspection hole.



STEP 2: M22520 series crimp tool and locator is recommended. See Contact and Tool Table on [pages 232-233](#) for choice of turret head and selection setting according to contact size, part number and wire gauge size.

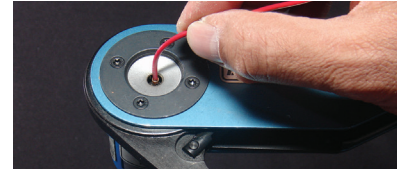

STEP 3: Insert contact and wire into tool jaws. To crimp, squeeze handles together fully until ratchet releases and allows handles to expand; otherwise, contact cannot be extracted from tool jaws. Maintain slight insertion pressure on wire while crimping contact to wire.

CONTACT INSERTION

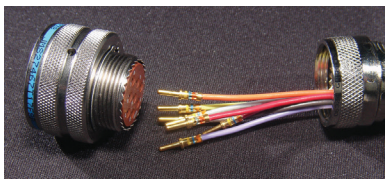

STEP 1: Remove hardware from plug or receptacle and slip over wire bundle in proper order for reassembly.



STEP 2: Using proper plastic or metal insertion tool for corresponding contact, position wire in tip of the tool so that the tool tip presses against the contact shoulder.

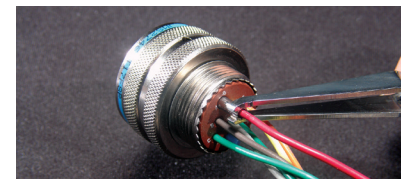

STEP 3: Press tool against contact shoulder and, with firm and even pressure, insert wired contact and tool tip into center contact cavity.

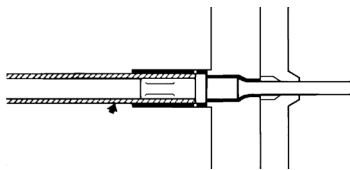

STEP 4: When contact bottoms, a slight "click" can be heard as tines of metal retaining clip snap into place behind contact shoulder.

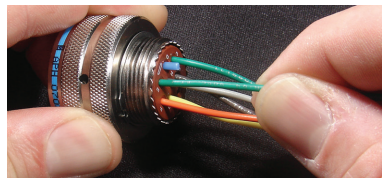

STEP 5: Remove tool and pull back lightly on wire to make sure contact is properly seated. Repeat operation with remainder of contacts to be inserted, beginning with the center cavity and working outward in alternating rows.



STEP 6: After all contacts are inserted, fill any empty cavities with wire sealing plugs. Reassemble plug or receptacle hardware.

CONTACT EXTRACTION

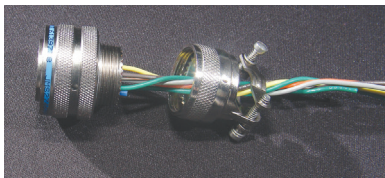

STEP 1: Remove hardware from plug or receptacle and slide hardware back along wire bundle.

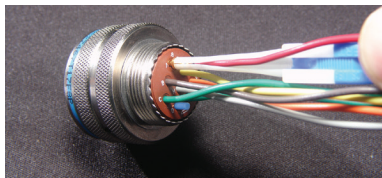

STEP 2: Using plastic or metal extraction tool with proper color code corresponding to contact size, place wire in tool.

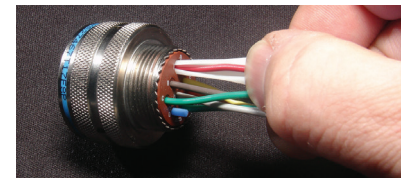

STEP 3: Insert tool into contact cavity until tool tip bottoms against the contact shoulder, expanding clip retaining tines.

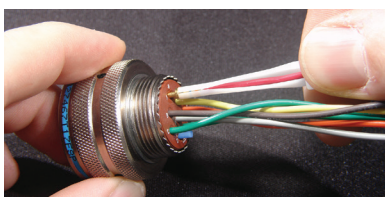

STEP 4: Hold wire firmly in tool and extract wired contact and tool. Repeat operation for all contacts to be extracted.

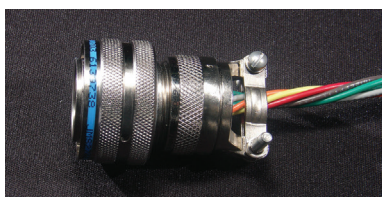

STEP 5: Fill any empty cavities with wire sealing plugs. Reassemble plug or receptacle hardware.

Note: LJT series shown.

All dimensions in inches (millimeters in parenthesis)