

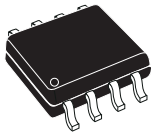

Automotive-grade, very high accuracy (25 μ V), high bandwidth (3 MHz), high temperature (150 $^{\circ}$ C), zero-drift operational amplifiers



SO8

Features

- AEC-Q100 qualified 
- Very high accuracy and stability:
 - 25 μ V max. offset voltage at 25 $^{\circ}$ C
 - 44 μ V offset voltage over full temperature range
- Rail-to-rail input and output
- Low supply voltage: 2.2 - 5.5 V
- Low power consumption: 1 mA max. at 5 V
- Gain bandwidth product: 3 MHz
- Extended temperature range: -40 to 150 $^{\circ}$ C
- Micropackage: SO8
- Benefits:
 - Higher accuracy without calibration
 - Accuracy virtually unaffected by temperature change

Applications

- High accuracy signal conditioning
- Current measurement
- Sensor signal conditioning
- Automotive

Description

The **TSZ182H** is a dual operational amplifier, featuring very low offset voltages with virtually zero-drift versus temperature changes. The **TSZ182H** offers rail-to-rail input and output, excellent speed/power consumption ratio, and 3 MHz gain bandwidth product, while consuming just 1 mA at 5 V. The device operates over an extended range of -40 to +150 $^{\circ}$ C and features an ultra-low input bias current. These features make the **TSZ182H** ideal for high-accuracy high-bandwidth sensor interfaces for automotive environment.

Product status link

[TSZ182H](#)

Related products

[TSZ182](#)

For -40/125 $^{\circ}$ C range

1 Package pin connections

Figure 1. Pin connections (top view)

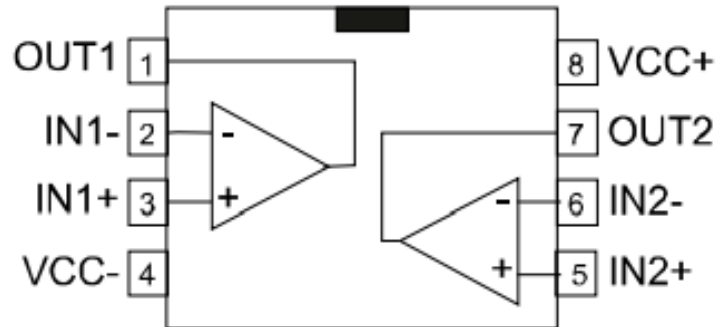

Table 1. Pin description

Pin	Pin name	Description
1	OUT1	Output
2	IN1 -	Negative input voltage
3	IN1 +	Positive input voltage
4	VCC -	Negative supply voltage
5	IN2 +	Positive input voltage
6	IN2 -	Negative input voltage
7	OUT2	Output
8	VCC +	Positive supply voltage

2 Absolute maximum ratings and operation conditions

Table 2. Absolute maximum ratings

Symbol	Parameter	Value	Unit
V_{CC}	Supply voltage ⁽¹⁾	6	V
V_{id}	Differential input voltage ⁽²⁾	$\pm V_{CC}$	V
V_{in}	Input voltage ⁽³⁾	$(V_{CC-})-0.2$ to $(V_{CC+})+0.2$	V
I_{in}	Input current ⁽⁴⁾	10	mA
T_{stg}	Storage temperature	-65 to 150	°C
T_j	Junction temperature	160	°C
R_{th-ja}	Thermal resistance junction to ambient ⁽⁵⁾⁽⁶⁾ SO8	125	°C/W
ESD	Human body model (HBM) ⁽⁷⁾	4	kV
	Charged device model (CDM) ⁽⁸⁾	1.5	
	Latch-up immunity	200	mA

1. All voltage values, except differential voltage, are with respect to network ground terminal.
2. The differential voltage is the non-inverting input terminal with respect to the inverting input terminal.
3. $V_{CC} - V_{in}$ must not exceed 6 V, V_{in} must not exceed 6 V.
4. Input current must be limited by a resistor in series with the inputs.
5. R_{th} are typical values.
6. Short-circuits can cause excessive heating and destructive dissipation.
7. Human body model: 100 pF discharged through a 1.5 kΩ resistor between two pins of the device, done for all couples of pin combinations with other pins floating.
8. Charged device model: all pins plus packages are charged together to the specified voltage and then discharged directly to ground.

Table 3. Operating conditions

Symbol	Parameter	Value	Unit
V_{CC}	Supply voltage	2.2 to 5.5	V
V_{icm}	Common mode voltage on input pins	$(V_{CC-})-0.1$ to $(V_{CC+})+0.1$	V
T	Operating free-air temperature range	-40 to 150	°C

3 Electrical characteristics

Table 4. Electrical characteristics ($V_{CC+} = 2.2\text{ V}$, $V_{CC-} = 0\text{ V}$, $V_{icm} = V_{CC}/2$, $T = 25\text{ }^{\circ}\text{C}$, $R_L = 10\text{ k}\Omega$ connected to $V_{CC}/2$, unless otherwise specified)

Symbol	Parameter	Conditions	Min.	Typ.	Max.	Unit
DC performance						
V_{IO}	Input offset voltage	$T = 25\text{ }^{\circ}\text{C}$		3.5	35	μV
		$T_{min} < T < T_{max}$			54	
$ \Delta V_{IO}/\Delta T $	Input offset voltage drift ⁽¹⁾	$T_{min} < T < T_{max}$			0.15	$\mu\text{V}/^{\circ}\text{C}$
I_{IB}	Input bias current ⁽²⁾ ($V_{OUT} = V_{CC}/2$)	$T = 25\text{ }^{\circ}\text{C}$		30	200	pA
		$T_{min} < T < T_{max}$			400	
I_{IO}	Input offset current ⁽²⁾ ($V_{OUT} = V_{CC}/2$)	$T = 25\text{ }^{\circ}\text{C}$		60	400	pA
		$T_{min} < T < T_{max}$			600	
CMR1	Common-mode rejection ratio ⁽³⁾ , $V_{ic} = 0\text{ V to } V_{CC}$, $V_{OUT} = V_{CC}/2$, $R_L > 1\text{ M}\Omega$	$T = 25\text{ }^{\circ}\text{C}$	96	115		dB
		$T_{min} < T < T_{max}$	90			
A_{vd}	Large signal voltage gain, $V_{OUT} = 0.5\text{ V to } (V_{CC} - 0.5\text{ V})$	$T = 25\text{ }^{\circ}\text{C}$	112	130		
		$T_{min} < T < T_{max}$	98			
V_{OH}	High-level output voltage, $V_{OH} = V_{CC} - V_{OUT}$	$T = 25\text{ }^{\circ}\text{C}$		15	40	mV
		$T_{min} < T < T_{max}$			70	
V_{OL}	Low-level output voltage	$T = 25\text{ }^{\circ}\text{C}$		10	30	mV
		$T_{min} < T < T_{max}$			70	
I_{OUT}	I_{sink} ($V_{OUT} = V_{CC}$)	$T = 25\text{ }^{\circ}\text{C}$	4	6		mA
		$T_{min} < T < T_{max}$	2.37			
	I_{source} ($V_{OUT} = 0\text{ V}$)	$T = 25\text{ }^{\circ}\text{C}$	3.5	4		
		$T_{min} < T < T_{max}$	1.9			
I_{CC}	Supply current per channel, $V_{OUT} = V_{CC}/2$, $R_L > 1\text{ M}\Omega$	$T = 25\text{ }^{\circ}\text{C}$		0.7	1	
		$T_{min} < T < T_{max}$			1.2	
AC performance						
GBP	Gain bandwidth product, $R_L = 10\text{ k}\Omega$, $C_L = 100\text{ pF}$	$T = 25\text{ }^{\circ}\text{C}$	1.6	2.3		MHz
		$T_{min} < T < T_{max}$	1.1			
Φ_m	Phase margin	$R_L = 10\text{ k}\Omega$, $C_L = 100\text{ pF}$		59		degrees
G_m	Gain margin			16		dB
S_R	Slew rate ⁽⁴⁾	$T = 25\text{ }^{\circ}\text{C}$	3	4.6		V/ μs
		$T_{min} < T < T_{max}$	2.5			
t_s	Settling time	To 0.1%, $V_{in} = 0.8\text{ Vpp}$		500		ns
en	Equivalent input noise voltage density	$f = 1\text{ kHz}$		50		nV/ $\sqrt{\text{Hz}}$
		$f = 10\text{ kHz}$		50		
en-pp	Voltage noise	$f = 0.1\text{ to } 10\text{ Hz}$		0.6		μVpp

Symbol	Parameter	Conditions	Min.	Typ.	Max.	Unit
C_s	Channel separation	$f = 1 \text{ kHz}$		120		dB
t_{init}	Initialization time, $G = 100^{(5)}$	$T = 25 \text{ }^\circ\text{C}$		60		μs
		$T_{\text{min}} < T < T_{\text{max}}$		100		

1. *Input offset measurements are performed on x100 gain configuration. The amplifiers and the gain setting resistors are at the same temperature.*
2. *Guaranteed by design.*
3. *CMR is defined as $20 \times \text{LOG}(\Delta_{V_{\text{icm}}}/\Delta_{V_{\text{io}}})$.*
4. *Slew rate value is calculated as the average between positive and negative slew rates.*
5. *Initialization time is defined as the delay between the moment when supply voltage exceeds 2.2 V and output voltage stabilization.*

Table 5. Electrical characteristics ($V_{CC+} = 3.3\text{ V}$, $V_{CC-} = 0\text{ V}$, $V_{icm} = V_{CC}/2$, $T = 25\text{ }^{\circ}\text{C}$, $R_L = 10\text{ k}\Omega$ connected to $V_{CC}/2$, unless otherwise specified)

Symbol	Parameter	Conditions	Min.	Typ.	Max.	Unit
DC performance						
V_{IO}	Input offset voltage	$T = 25\text{ }^{\circ}\text{C}$		2	30	μV
		$T_{min} < T < T_{max}$			49	
$ \Delta V_{IO}/\Delta T $	Input offset voltage drift ⁽¹⁾	$T_{min} < T < T_{max}$			0.15	$\mu\text{V}/^{\circ}\text{C}$
I_{IB}	Input bias current ($V_{OUT} = V_{CC}/2$)	$T = 25\text{ }^{\circ}\text{C}$		30	200	pA
		$T_{min} < T < T_{max}$			400	
I_{IO}	Input offset current ⁽²⁾ ($V_{OUT} = V_{CC}/2$)	$T = 25\text{ }^{\circ}\text{C}$		60	400	pA
		$T_{min} < T < T_{max}$			600	
CMR1	Common-mode rejection ratio ⁽³⁾ , $V_{ic} = 0\text{ V to } V_{CC}$, $V_{OUT} = V_{CC}/2$, $R_L > 1\text{ M}\Omega$	$T = 25\text{ }^{\circ}\text{C}$	104	120		dB
		$T_{min} < T < T_{max}$	100			
CMR2	Common-mode rejection ratio ⁽³⁾ , $V_{OUT} = V_{CC}/2$, $R_L > 1\text{ M}\Omega$	$T = 25\text{ }^{\circ}\text{C}$, $V_{ic} = 0\text{ to } V_{CC} - 1.8\text{ V}$	106	132		dB
		$T_{min} < T < T_{max}$, $V_{ic} = 0\text{ to } V_{CC} - 2\text{ V}$	104			
A_{vd}	Large signal voltage gain, $V_{OUT} = 0.5\text{ V to } (V_{CC} - 0.5\text{ V})$	$T = 25\text{ }^{\circ}\text{C}$	120	138		
		$T_{min} < T < T_{max}$	110			
V_{OH}	High-level output voltage, $V_{OH} = V_{CC} - V_{OUT}$	$T = 25\text{ }^{\circ}\text{C}$		16	40	mV
		$T_{min} < T < T_{max}$			70	
V_{OL}	Low-level output voltage	$T = 25\text{ }^{\circ}\text{C}$		11	30	mV
		$T_{min} < T < T_{max}$			70	
I_{OUT}	$I_{sink} (V_{OUT} = V_{CC})$	$T = 25\text{ }^{\circ}\text{C}$	10	15		mA
		$T_{min} < T < T_{max}$	7.1			
	$I_{source} (V_{OUT} = 0\text{ V})$	$T = 25\text{ }^{\circ}\text{C}$	6	11		
		$T_{min} < T < T_{max}$	3.8			
I_{CC}	Supply current per channel, $V_{OUT} = V_{CC}/2$, $R_L > 1\text{ M}\Omega$	$T = 25\text{ }^{\circ}\text{C}$		0.7	1	
		$T_{min} < T < T_{max}$			1.2	
AC performance						
GBP	Gain bandwidth product, $R_L = 10\text{ k}\Omega$, $C_L = 100\text{ pF}$	$T = 25\text{ }^{\circ}\text{C}$	2	2.8		MHz
		$T_{min} < T < T_{max}$	1.5			
Φ_m	Phase margin	$R_L = 10\text{ k}\Omega$, $C_L = 100\text{ pF}$		56		degrees
G_m	Gain margin			15		dB
SR	Slew rate ⁽⁴⁾	$T = 25\text{ }^{\circ}\text{C}$	2.6	4.5		V/ μs
		$T_{min} < T < T_{max}$	2.1			
t_s	Settling time	$T_0 = 0.1\%$, $V_{in} = 1.2\text{ V}_{pp}$		550		ns
e_n	Equivalent input noise voltage density	$f = 1\text{ kHz}$		40		nV/ $\sqrt{\text{Hz}}$
		$f = 10\text{ kHz}$		40		

Symbol	Parameter	Conditions	Min.	Typ.	Max.	Unit
en-pp	Voltage noise	f = 0.1 to 10 Hz		0.5		μVpp
C _s	Channel separation	f=1 kHz		120		dB
t _{int}	Initialization time, G=100 ⁽⁵⁾	T = 25 °C		60		μs
		Tmin < T < Tmax		100		

1. Input offset measurements are performed on x100 gain configuration. The amplifiers and the gain setting resistors are at the same temperature.
2. Guaranteed by design.
3. CMR is defined as $20 \times \text{LOG}(\Delta_{V_{icm}}/\Delta_{V_{io}})$.
4. Slew rate value is calculated as the average between positive and negative slew rates.
5. Initialization time is defined as the delay between the moment when supply voltage exceeds 2.2 V and output voltage stabilization.

Table 6. Electrical characteristics ($V_{CC+} = 5\text{ V}$, $V_{CC-} = 0\text{ V}$, $V_{icm} = V_{CC}/2$, $T = 25\text{ }^{\circ}\text{C}$, $R_L = 10\text{ k}\Omega$ connected to $V_{CC}/2$, unless otherwise specified)

Symbol	Parameter	Conditions	Min.	Typ.	Max.	Unit
DC performance						
V_{IO}	Input offset voltage	$T = 25\text{ }^{\circ}\text{C}$		1	25	μV
		$T_{min} < T < T_{max}$			44	
$ \Delta V_{IO}/\Delta T $	Input offset voltage drift ⁽¹⁾	$T_{min} < T < T_{max}$			0.15	$\mu\text{V}/^{\circ}\text{C}$
I_{IB}	Input bias current ⁽²⁾ ($V_{OUT} = V_{CC}/2$)	$T = 25\text{ }^{\circ}\text{C}$		30	200	pA
		$T_{min} < T < T_{max}$			400	
I_{IO}	Input offset current ⁽²⁾ ($V_{OUT} = V_{CC}/2$)	$T = 25\text{ }^{\circ}\text{C}$		60	400	pA
		$T_{min} < T < T_{max}$			600	
CMR1	Common-mode rejection ratio ⁽³⁾ , $V_{ic} = 0\text{ V to } V_{CC}$, $V_{OUT} = V_{CC}/2$, $R_L > 1\text{ M}\Omega$	$T = 25\text{ }^{\circ}\text{C}$	108	126		dB
		$T_{min} < T < T_{max}$	106			
CMR2	Common-mode rejection ratio ⁽³⁾ , $V_{ic} = 0\text{ V to } V_{CC}$, $V_{OUT} = V_{CC}/2$, $R_L > 1\text{ M}\Omega$	$T = 25\text{ }^{\circ}\text{C}$, $V_{ic} = 0\text{ to } V_{CC} - 1.8\text{ V}$	112	136		dB
		$T_{min} < T < T_{max}$, $V_{ic} = 0\text{ to } V_{CC} - 2\text{ V}$	110			
SVR1	Supply voltage rejection ratio $V_{CC} = 2.2\text{ to } 5.5\text{ V}$, $V_{ic} = 0\text{ V}$, $R_L > 1\text{ M}\Omega$	$T = 25\text{ }^{\circ}\text{C}$	105	123		dB
		$T_{min} < T < T_{max}$	104			
A_{vd}	Large signal voltage gain, $V_{OUT} = 0.5\text{ V to } (V_{CC} - 0.5\text{ V})$	$T = 25\text{ }^{\circ}\text{C}$	120	144		dB
		$T_{min} < T < T_{max}$	110			
EMIRR	EMI rejection ratio ⁽⁵⁾	$V_{RF} = 100\text{ mVp}$, $f = 400\text{ MHz}$		52		dB
		$V_{RF} = 100\text{ mVp}$, $f = 900\text{ MHz}$		52		
		$V_{RF} = 100\text{ mVp}$, $f = 1800\text{ MHz}$		72		
		$V_{RF} = 100\text{ mVp}$, $f = 2400\text{ MHz}$		85		
V_{OH}	High-level output voltage, $V_{OH} = V_{CC} - V_{OUT}$	$T = 25\text{ }^{\circ}\text{C}$		18	40	mV
		$T_{min} < T < T_{max}$			70	
V_{OL}	Low-level output voltage	$T = 25\text{ }^{\circ}\text{C}$		13	30	mV
		$T_{min} < T < T_{max}$			70	
I_{OUT}	I_{sink} ($V_{OUT} = V_{CC}$)	$T = 25\text{ }^{\circ}\text{C}$	20	29		mA
		$T_{min} < T < T_{max}$	14			
	I_{source} ($V_{OUT} = 0\text{ V}$)	$T = 25\text{ }^{\circ}\text{C}$	15	25		
		$T_{min} < T < T_{max}$	9			
I_{CC}	Supply current per channel, $V_{OUT} = V_{CC}/2$, $R_L > 1\text{ M}\Omega$	$T = 25\text{ }^{\circ}\text{C}$		0.8	1	mA
		$T_{min} < T < T_{max}$			1.2	
AC performance						
GBP	Gain bandwidth product, $R_L = 10\text{ k}\Omega$, $C_L = 100\text{ pF}$	$T = 25\text{ }^{\circ}\text{C}$	2	3		MHz
		$T_{min} < T < T_{max}$	1.5			
Φ_m	Phase margin	$R_L = 10\text{ k}\Omega$, $C_L = 100\text{ pF}$		56		Degrees
G_m	Gain margin			15		dB
SR	Slew rate ⁽⁶⁾	$T = 25\text{ }^{\circ}\text{C}$	2.9	4.7		$\text{V}/\mu\text{s}$

Symbol	Parameter	Conditions	Min.	Typ.	Max.	Unit
SR	Slew rate ⁽⁶⁾	Tmin < T < Tmax	2.4			V/μs
t _s	Settling time	To 0.1%, Vin=1.5 Vpp		600		ns
		To 0.01%, Vin=1 Vpp		4		μs
e _n	Equivalent input noise voltage density	f = 1 kHz		37		nV/√Hz
		f = 10 kHz		37		
en-pp	Voltage noise	f=0.1 to 10 Hz		0.4		μVpp
C _s	Channel separation	f = 100 Hz		135		dB
t _{init}	Initialization time, G=100 ⁽⁷⁾	T = 25 °C		60		μs
		Tmin < T < Tmax		100		

1. Input offset measurements are performed on x100 gain configuration. The amplifiers and the gain setting resistors are at the same temperature.
2. Guaranteed by design
3. CMR is defined as $20 \times \text{LOG}(\Delta V_{icm} / \Delta V_{io})$.
4. SVR is defined as $20 \times \text{LOG}(\Delta V_{cc} / \Delta V_{io})$.
5. EMIRR is defined as $-20 \text{Log}(V_{RF_Peak} / \Delta V_{io})$, tested on the MiniSO8 package, RF injection on the IN- pin.
6. Slew rate value is calculated as the average between positive and negative slew rates.
7. Initialization time is defined as the delay between the moment when supply voltage exceeds 2.2 V and output voltage stabilization.

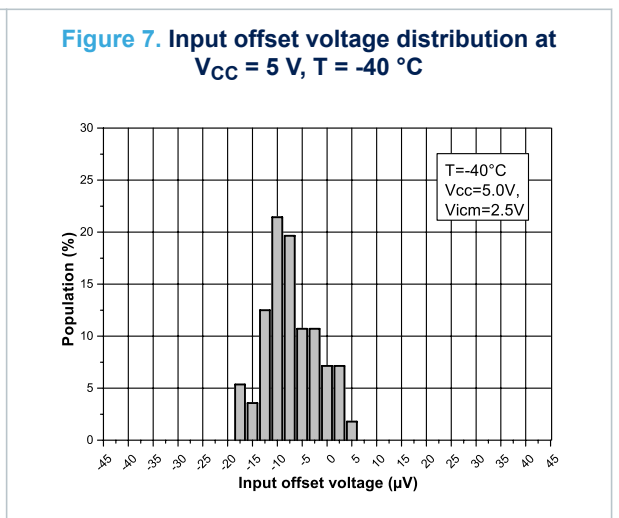
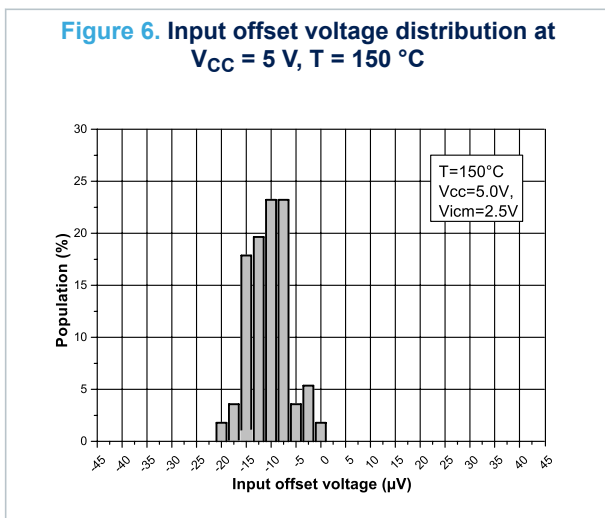
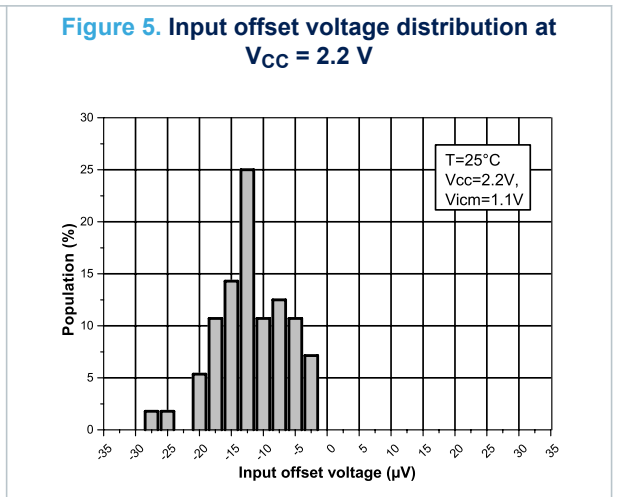
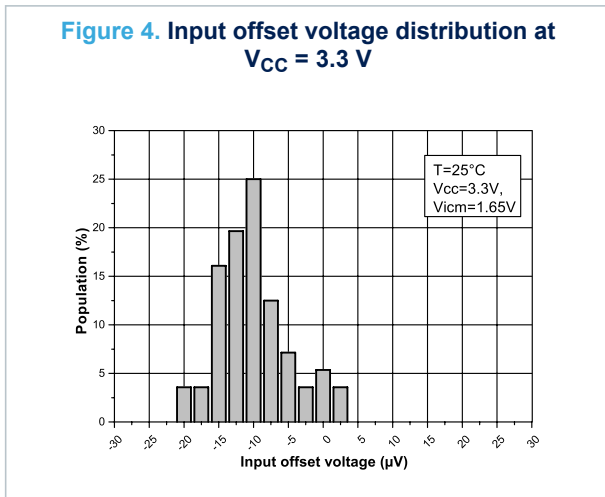
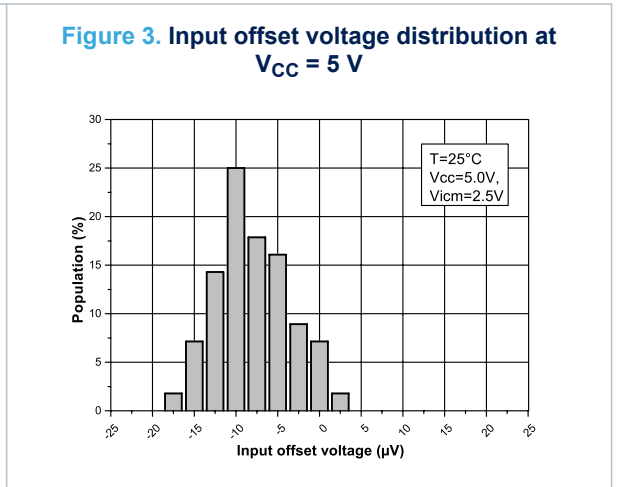
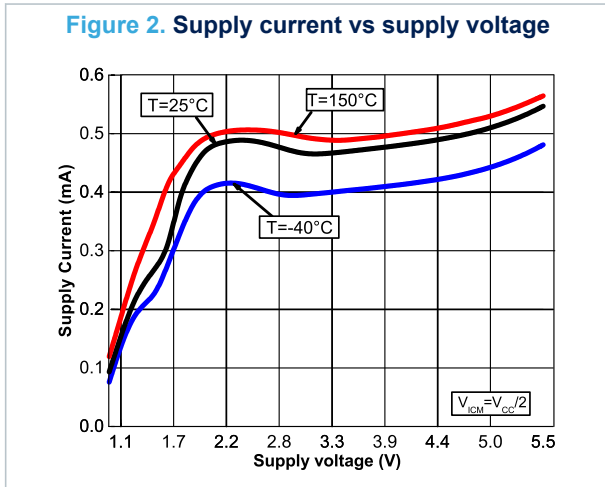

Figure 8. Input offset voltage distribution at $V_{CC}=2.2\text{ V}$, $T = 150\text{ }^{\circ}\text{C}$

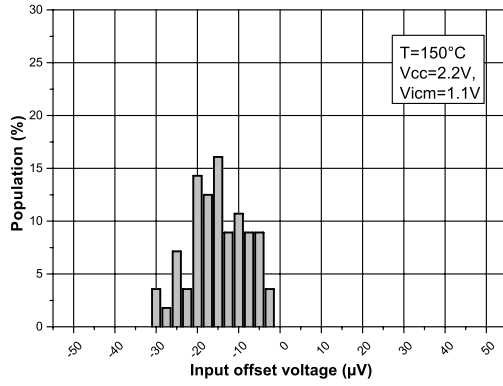

Figure 9. Input offset voltage distribution at $V_{CC}=2.2\text{ V}$, $T = -40\text{ }^{\circ}\text{C}$

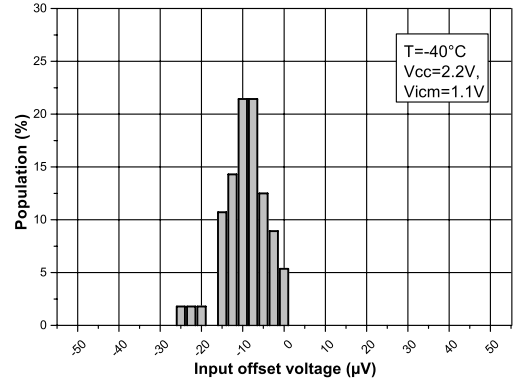

Figure 10. Input offset voltage vs supply voltage

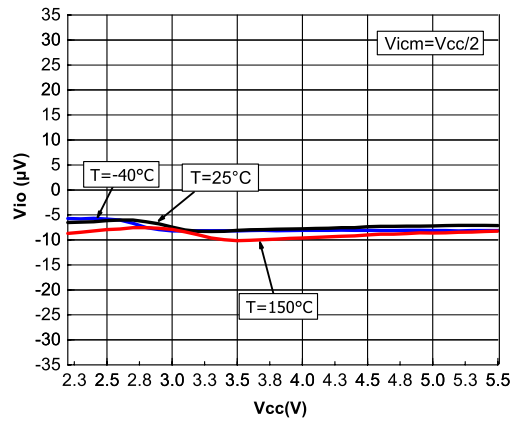

Figure 11. Input offset voltage vs input common mode at $V_{CC}= 5\text{ V}$

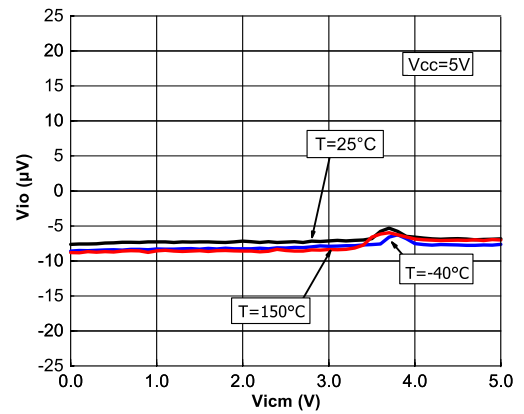

Figure 12. Input offset voltage vs input common mode at $V_{CC}= 3.3\text{ V}$

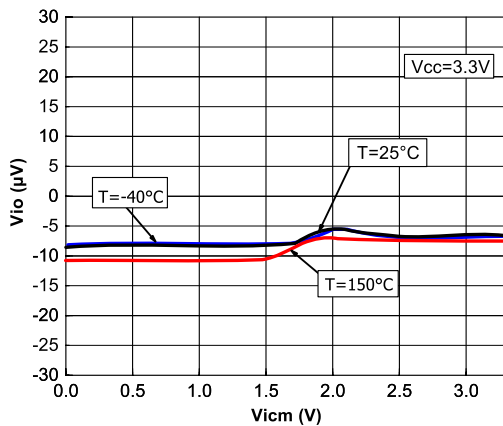

Figure 13. Input offset voltage vs input common mode at $V_{CC}= 2.2\text{ V}$

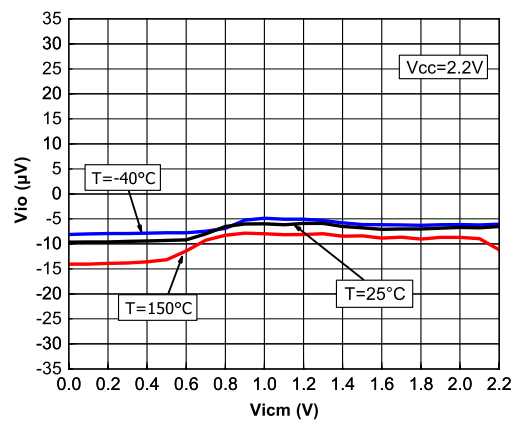

Figure 14. Input offset voltage vs temperature

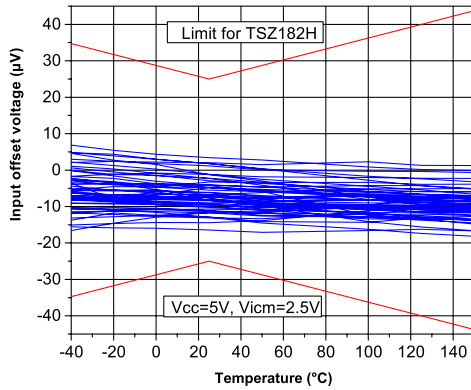

Figure 15. V_{OH} vs supply voltage

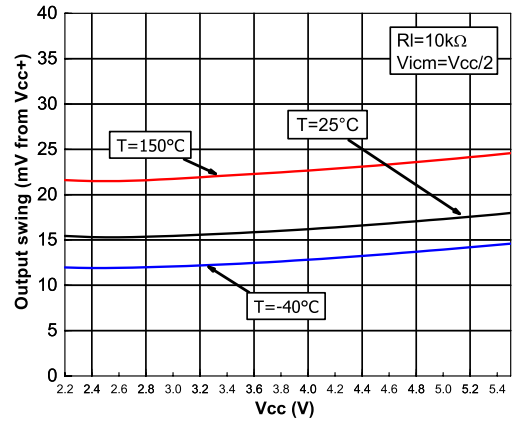

Figure 16. V_{OL} vs supply voltage

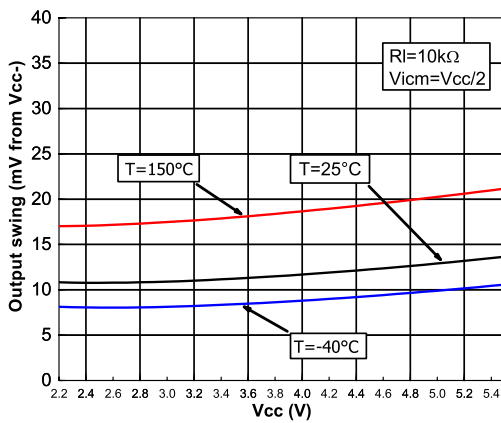

Figure 17. Output current vs output voltage at $V_{CC} = 5\text{ V}$

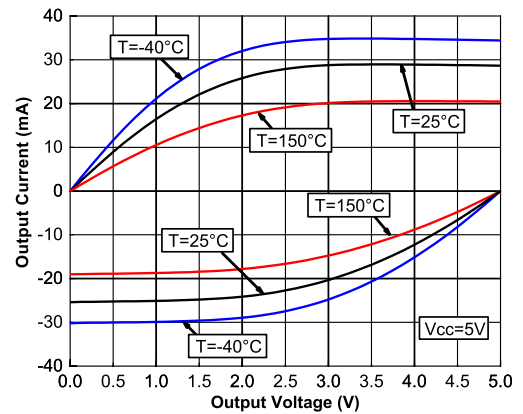

Figure 18. Output current vs. output voltage at $V_{CC} = 2.2\text{ V}$

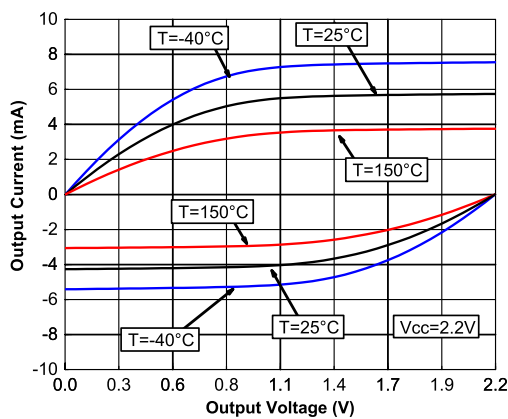

Figure 19. Input bias current vs common-mode at $V_{CC} = 5\text{ V}$

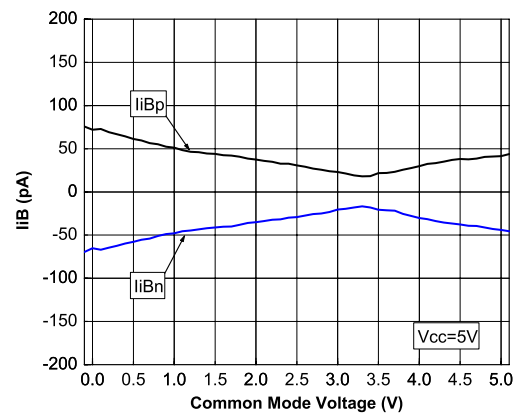

Figure 20. Input bias current vs. temperature at $V_{CC} = 5\text{ V}$

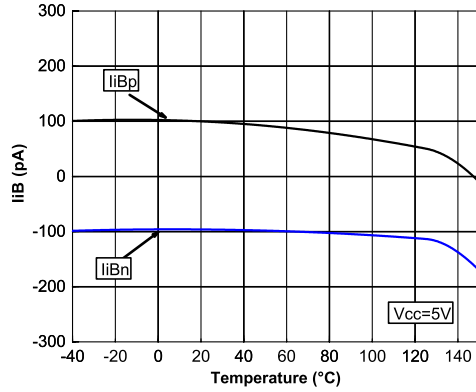

Figure 21. Output rail linearity

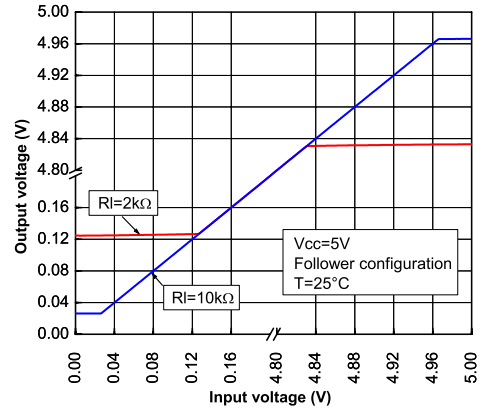

Figure 22. Bode diagram at $V_{CC}=5\text{ V}$

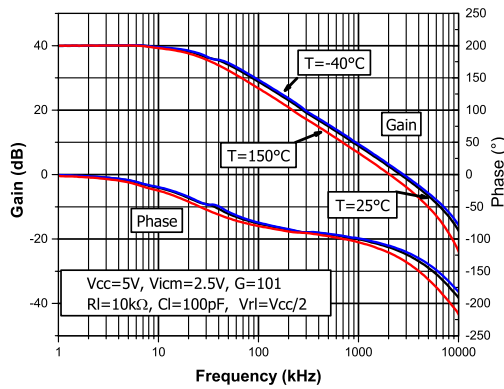

Figure 23. Bode diagram at $V_{CC}=2.2\text{ V}$

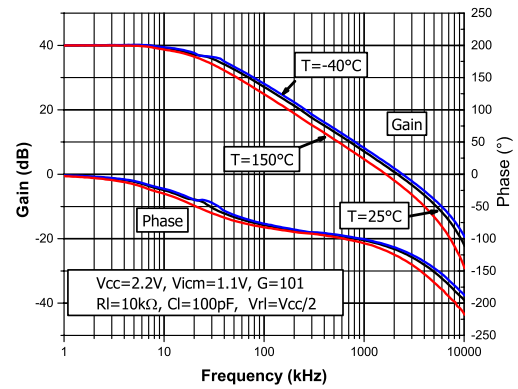

Figure 24. Bode diagram at $V_{CC}=3.3\text{ V}$

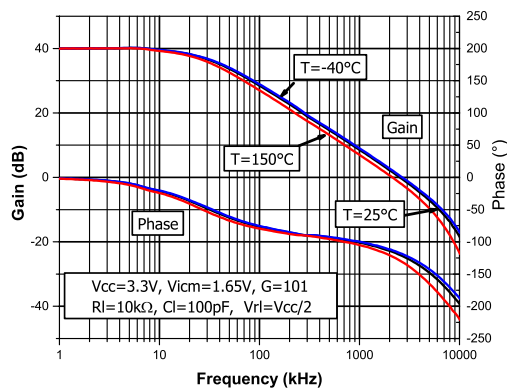

Figure 25. Open loop gain vs frequency

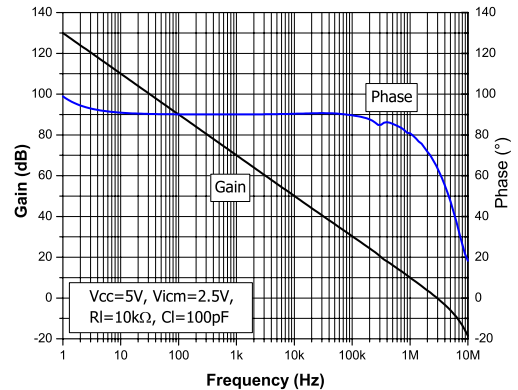

Figure 26. Positive slew rate vs supply voltage

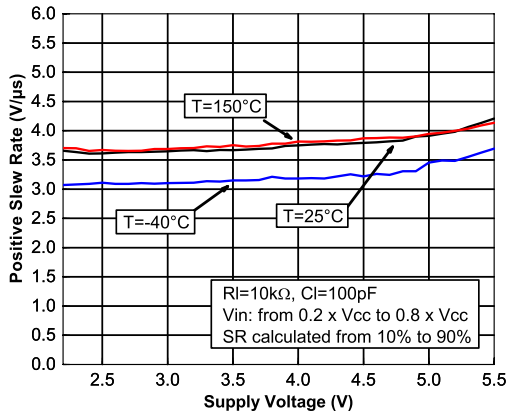

Figure 27. Negative slew rate vs supply voltage

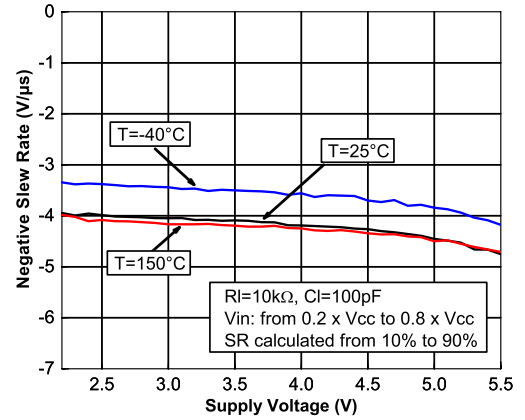

Figure 28. Noise 0.1 – 10 Hz vs time

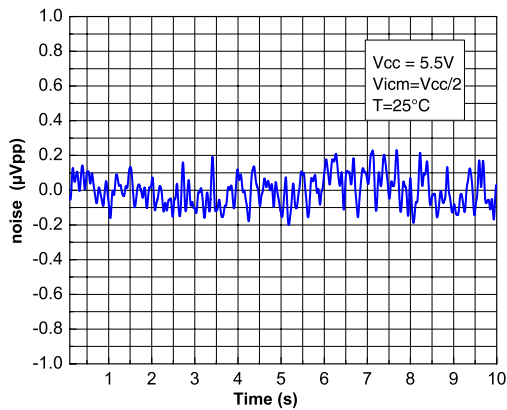

Figure 29. Noise vs frequency

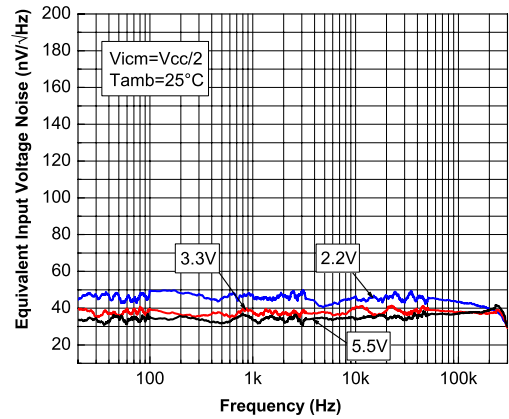

Figure 30. Output overshoot vs load capacitance

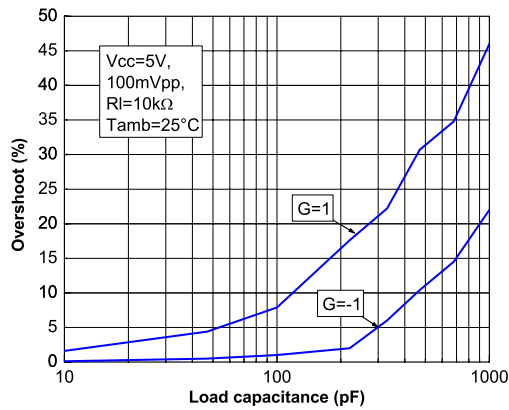

Figure 31. Small signal $V_{CC} = 5\text{ V}$

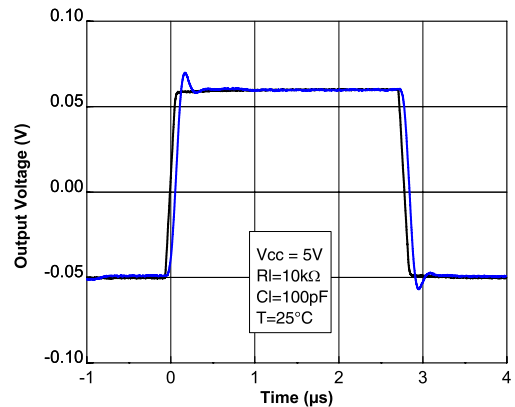

Figure 32. Small signal $V_{CC} = 2.2\text{ V}$

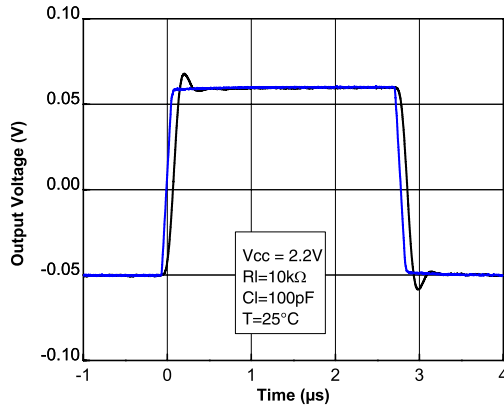

Figure 33. Large signal $V_{CC} = 5\text{ V}$

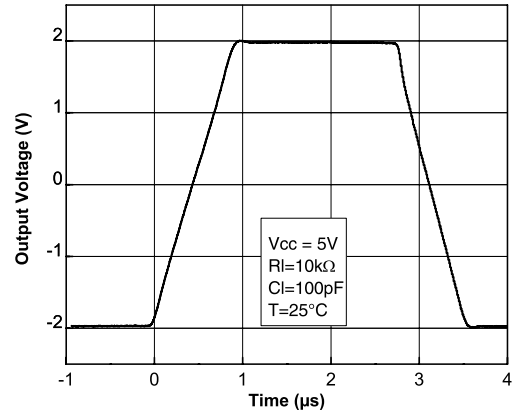

Figure 34. Large signal $V_{CC} = 2.2\text{ V}$

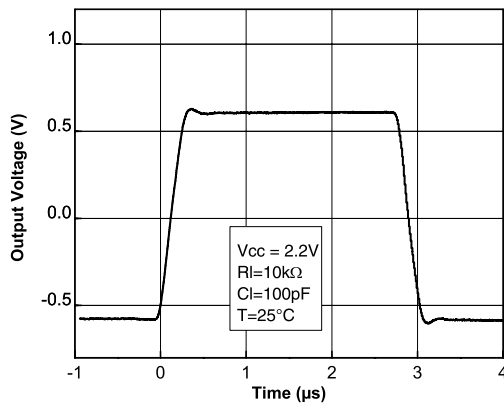

Figure 35. Negative overvoltage recovery
 $V_{CC} = 2.2\text{ V}$

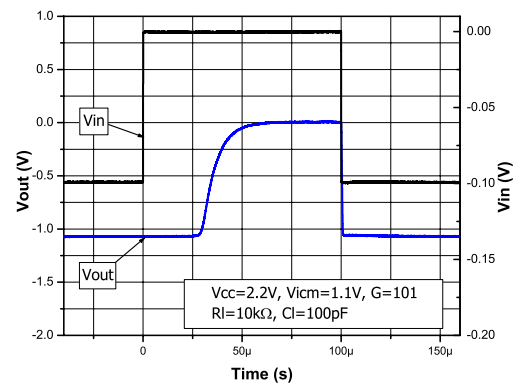

Figure 36. Positive overvoltage recovery $V_{CC} = 5\text{ V}$

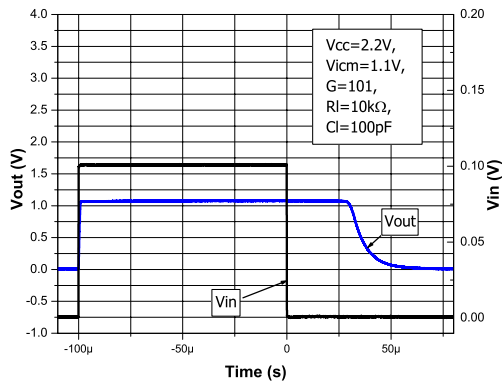

Figure 37. Output impedance vs frequency

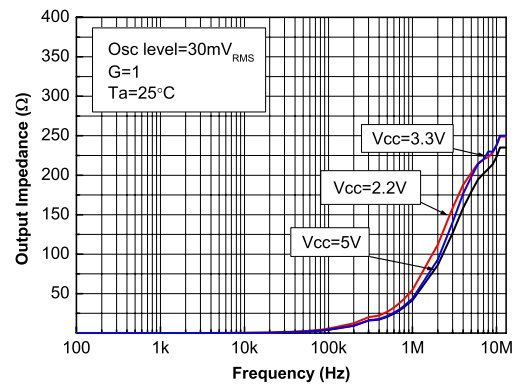

Figure 38. Settling time positive step (-2 V to 0 V)

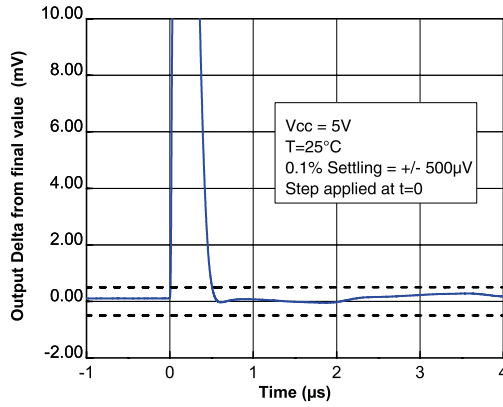

Figure 39. Settling time negative step (2 V to 0 V)

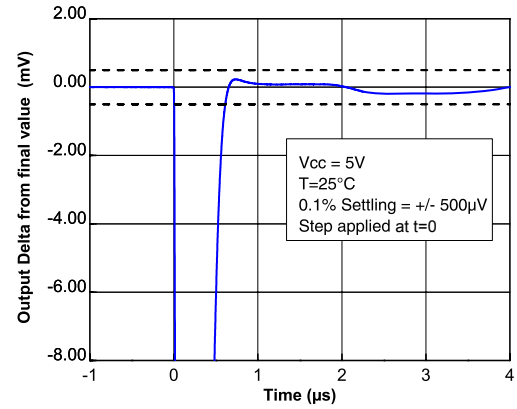

Figure 40. Settling time positive step (-0.8 V to 0 V)

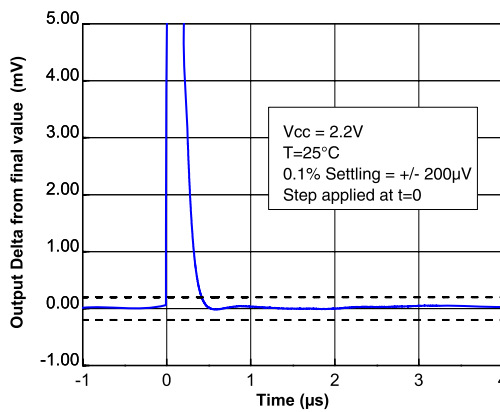

Figure 41. Settling time negative step (0.8 V to 0 V)

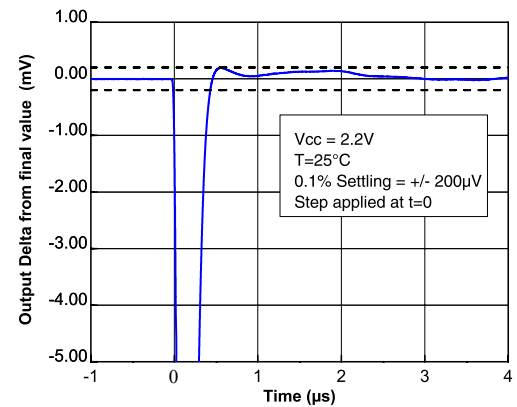

Figure 42. Maximum output voltage vs frequency

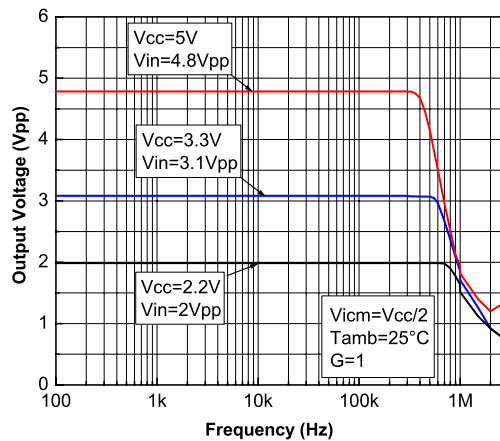

Figure 43. Crosstalk vs frequency

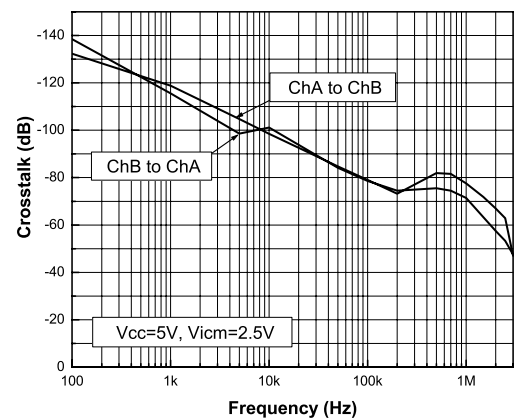
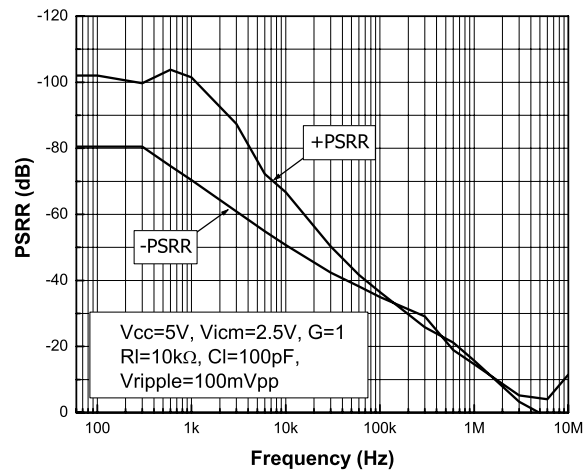

Figure 44. PSRR vs frequency



4 Package information

In order to meet environmental requirements, ST offers these devices in different grades of **ECOPACK** packages, depending on their level of environmental compliance. ECOPACK specifications, grade definitions and product status are available at: www.st.com. ECOPACK is an ST trademark.

4.1 SO8 package information

Figure 45. SO8 package outline

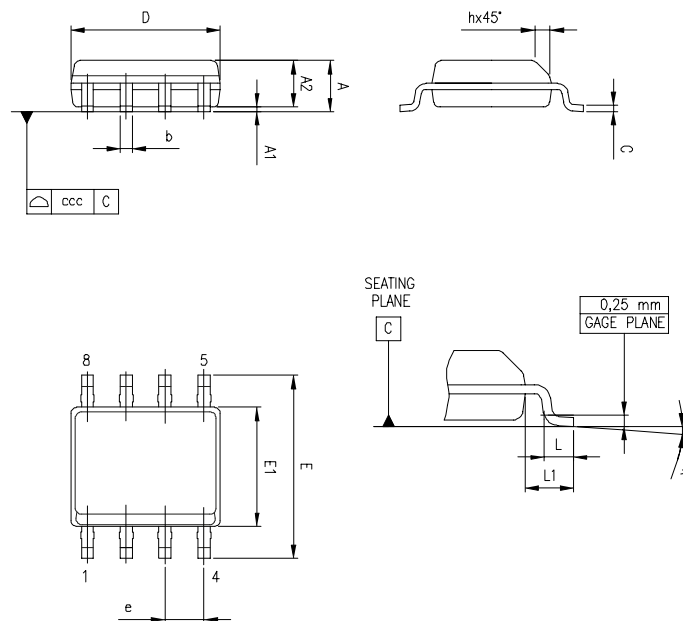

Table 7. SO-8 mechanical data

Dim.	mm			Inches		
	Min.	Typ.	Max.	Min.	Typ.	Max.
A			1.75			0.069
A1	0.1		0.25	0.004		0.01
A2	1.25			0.049		
b	0.28		0.48	0.011		0.019
c	0.17		0.23	0.007		0.01
D	4.8	4.9	5	0.189	0.193	0.197
E	5.8	6	6.2	0.228	0.236	0.244
E1	3.8	3.9	4	0.15	0.154	0.157
e		1.27			0.05	
h	0.25		0.5	0.01		0.02
L	0.4		1.27	0.016		0.05
L1		1.04			0.04	
k	0		8 °	1 °		8 °
ccc			0.1			0.004

5 Ordering information

Table 8. Ordering information

Order code	Package	Packing	Marking
TSZ182HYDT	SO8	Tape and reel	TSZ182H

Revision history

Table 9. Document revision history

Date	Version	Changes
20-Jan-2020	1	Initial release.

Contents

1	Package pin connections	2
2	Absolute maximum ratings and operation conditions	3
3	Electrical characteristics	4
4	Package information	18
4.1	SO8 package information	18
5	Ordering information	19
	Revision history	20

List of tables

Table 1.	Pin description	2
Table 2.	Absolute maximum ratings	3
Table 3.	Operating conditions	3
Table 4.	Electrical characteristics ($V_{CC+} = 2.2\text{ V}$, $V_{CC-} = 0\text{ V}$, $V_{icm} = V_{CC}/2$, $T = 25\text{ }^{\circ}\text{C}$, $R_L = 10\text{ k}\Omega$ connected to $V_{CC}/2$, unless otherwise specified)	4
Table 5.	Electrical characteristics ($V_{CC+} = 3.3\text{ V}$, $V_{CC-} = 0\text{ V}$, $V_{icm} = V_{CC}/2$, $T = 25\text{ }^{\circ}\text{C}$, $R_L = 10\text{ k}\Omega$ connected to $V_{CC}/2$, unless otherwise specified)	6
Table 6.	Electrical characteristics ($V_{CC+} = 5\text{ V}$, $V_{CC-} = 0\text{ V}$, $V_{icm} = V_{CC}/2$, $T = 25\text{ }^{\circ}\text{C}$, $R_L = 10\text{ k}\Omega$ connected to $V_{CC}/2$, unless otherwise specified)	8
Table 7.	SO-8 mechanical data	18
Table 8.	Ordering information.	19
Table 9.	Document revision history	20

List of figures

Figure 1.	Pin connections (top view)	2
Figure 2.	Supply current vs supply voltage	10
Figure 3.	Input offset voltage distribution at $V_{CC} = 5\text{ V}$	10
Figure 4.	Input offset voltage distribution at $V_{CC} = 3.3\text{ V}$	10
Figure 5.	Input offset voltage distribution at $V_{CC} = 2.2\text{ V}$	10
Figure 6.	Input offset voltage distribution at $V_{CC} = 5\text{ V}$, $T = 150\text{ }^{\circ}\text{C}$	10
Figure 7.	Input offset voltage distribution at $V_{CC} = 5\text{ V}$, $T = -40\text{ }^{\circ}\text{C}$	10
Figure 8.	Input offset voltage distribution at $V_{CC}=2.2\text{ V}$, $T = 150\text{ }^{\circ}\text{C}$	11
Figure 9.	Input offset voltage distribution at $V_{CC}=2.2\text{ V}$, $T = -40\text{ }^{\circ}\text{C}$	11
Figure 10.	Input offset voltage vs supply voltage	11
Figure 11.	Input offset voltage vs input common mode at $V_{CC} = 5\text{ V}$	11
Figure 12.	Input offset voltage vs input common mode at $V_{CC}= 3.3\text{ V}$	11
Figure 13.	Input offset voltage vs input common mode at $V_{CC}= 2.2\text{ V}$	11
Figure 14.	Input offset voltage vs temperature	12
Figure 15.	V_{OH} vs supply voltage	12
Figure 16.	V_{OL} vs supply voltage	12
Figure 17.	Output current vs output voltage at $V_{CC} = 5\text{ V}$	12
Figure 18.	Output current vs. output voltage at $V_{CC} = 2.2\text{ V}$	12
Figure 19.	Input bias current vs common-mode at $V_{CC} = 5\text{ V}$	12
Figure 20.	Input bias current vs. temperature at $V_{CC} = 5\text{ V}$	13
Figure 21.	Output rail linearity	13
Figure 22.	Bode diagram at $V_{CC}=5\text{ V}$	13
Figure 23.	Bode diagram at $V_{CC}=2.2\text{ V}$	13
Figure 24.	Bode diagram at $V_{CC}=3.3\text{ V}$	13
Figure 25.	Open loop gain vs frequency	13
Figure 26.	Positive slew rate vs supply voltage.	14
Figure 27.	Negative slew rate vs supply voltage	14
Figure 28.	Noise 0.1 – 10 Hz vs time	14
Figure 29.	Noise vs frequency	14
Figure 30.	Output overshoot vs load capacitance	14
Figure 31.	Small signal $V_{CC} = 5\text{ V}$	14
Figure 32.	Small signal $V_{CC} = 2.2\text{ V}$	15
Figure 33.	Large signal $V_{CC} = 5\text{ V}$	15
Figure 34.	Large signal $V_{CC} = 2.2\text{ V}$	15
Figure 35.	Negative overvoltage recovery $V_{CC} = 2.2\text{ V}$	15
Figure 36.	Positive overvoltage recovery $V_{CC} = 5\text{ V}$	15
Figure 37.	Output impedance vs frequency	15
Figure 38.	Settling time positive step (-2 V to 0 V).	16
Figure 39.	Settling time negative step (2 V to 0 V)	16
Figure 40.	Settling time positive step (-0.8 V to 0 V)	16
Figure 41.	Settling time negative step (0.8 V to 0 V)	16
Figure 42.	Maximum output voltage vs frequency	16
Figure 43.	Crosstalk vs frequency	16
Figure 44.	PSSR vs frequency	17
Figure 45.	SO8 package outline	18

IMPORTANT NOTICE – PLEASE READ CAREFULLY

STMicroelectronics NV and its subsidiaries (“ST”) reserve the right to make changes, corrections, enhancements, modifications, and improvements to ST products and/or to this document at any time without notice. Purchasers should obtain the latest relevant information on ST products before placing orders. ST products are sold pursuant to ST’s terms and conditions of sale in place at the time of order acknowledgement.

Purchasers are solely responsible for the choice, selection, and use of ST products and ST assumes no liability for application assistance or the design of Purchasers’ products.

No license, express or implied, to any intellectual property right is granted by ST herein.

Resale of ST products with provisions different from the information set forth herein shall void any warranty granted by ST for such product.

ST and the ST logo are trademarks of ST. For additional information about ST trademarks, please refer to www.st.com/trademarks. All other product or service names are the property of their respective owners.

Information in this document supersedes and replaces information previously supplied in any prior versions of this document.

© 2020 STMicroelectronics – All rights reserved