

TP SERIES

SUBMINIATURE WASHABLE MOMENTARY PUSHBUTTON SWITCHES

Overview

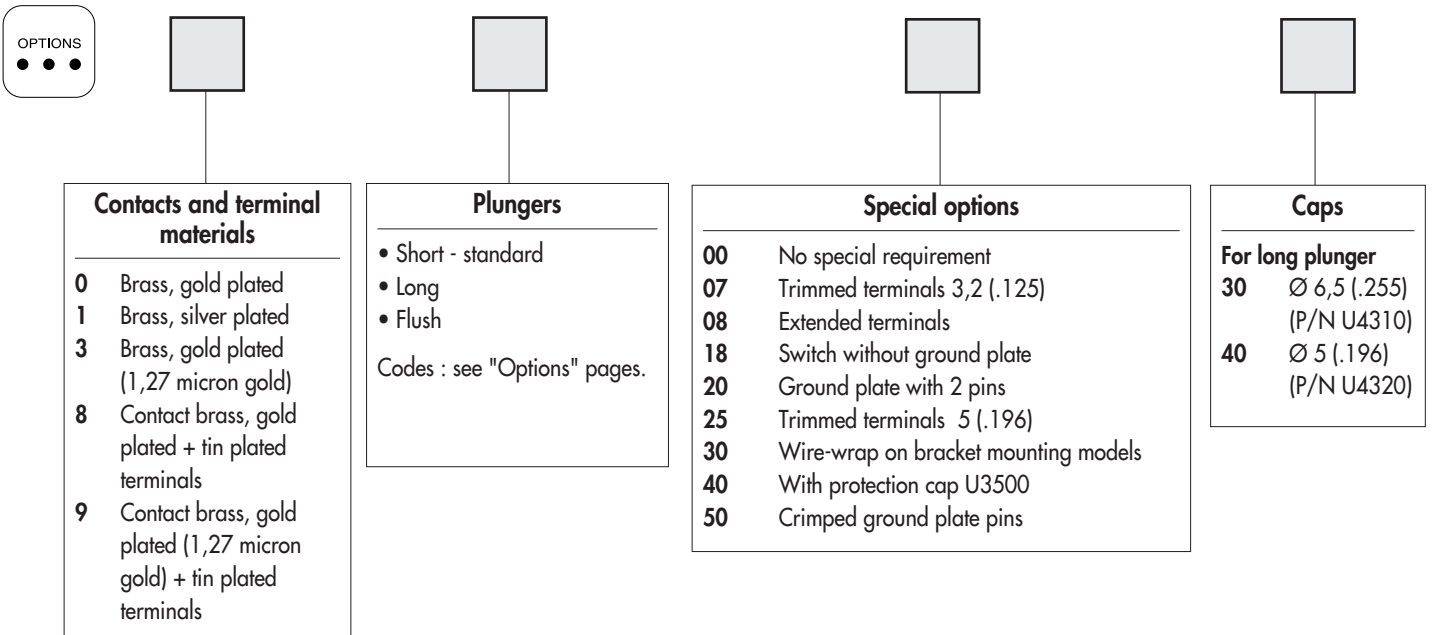
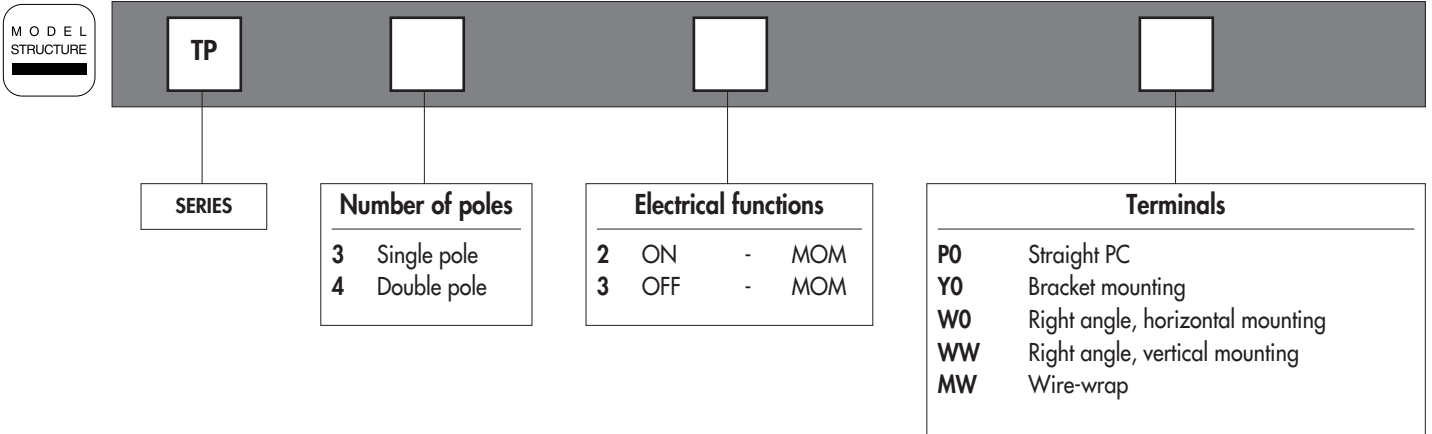

ABOUT THIS SERIES

On the following pages, you will find successively :

- specifications
- model structure of switches
- options in the same order as in above chart

Dimensions : first dimensions are in mm while inches are shown as bracketted numbers.

NOTICE : please note that not all combinations of above numbers are available. Refer to the following pages for further information.

Packaging unit : 100 pieces, except for models with WW terminals (50 pieces).

TP SERIES

SUBMINIATURE WASHABLE MOMENTARY PUSHBUTTON SWITCHES

Specifications

ELECTRICAL SPECIFICATIONS

- Max. current/voltage rating with resistive load :
 - gold plated contacts : 0,4VA 20V max. AC or DC
 - silver plated contacts : 0,5A 48V max. AC or DC
- Minimum load : 10mA 50mV - 10 μ A 5VDC
- Contact resistance : 50 m Ω max.
- Insulation resistance : 1.000 M Ω min. at 500VDC
- Dielectric strength :
 - 1.000 Vrms 50 Hz min. between terminals and frame
 - 500 Vrms 50 Hz min. between terminals
- Electrical life at full load :
 - gold plated contacts : 60.000 cycles
 - silver plated contacts : 20.000 cycles

MATERIALS

- Case : PBT
- Actuator : polyamide, glass filled
- Contacts and terminals :
 - 0** : brass, gold plated
 - 1** : brass, silver plated
 - 3** : brass, gold plated (1,27 micron gold)
 - 8** : contact brass, gold plated + tin plated terminals
 - 9** : contact brass, gold plated (1,27 micron gold) + tin plated terminals
- Terminal seal : epoxy

GENERAL SPECIFICATIONS

- Total travel :
 - function 2 : 1 mm (.039)
 - function 3 : 0,8 mm (.031)
- Strength of terminals : pull-out force - 10N max.
- Operating temperature : -30°C to +85°C
- Moisture : 21 days 95 % (NFC 20-603 - IEC 68-2-3)
- Cleaning : solvents or water + detergent
- Wave soldering : 260°C - 5 sec.

SOLDERING

Compatible wave soldering processes : see specifications S and SF, section B.

TP SERIES

SUBMINIATURE WASHABLE MOMENTARY PUSHBUTTON SWITCHES

MODEL
STRUCTURE

A

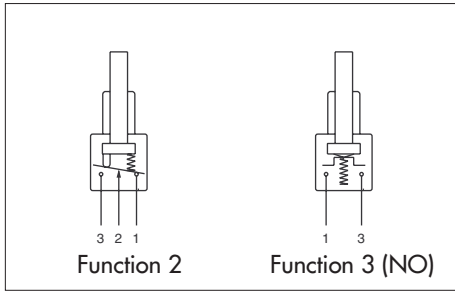

- Straight PC, right angle or wire-wrap terminals
- 1 and 2 pole configurations

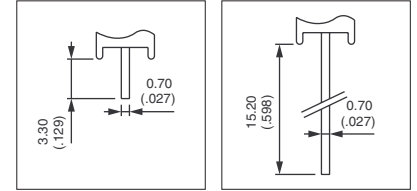

**MODEL
STRUCTURE**

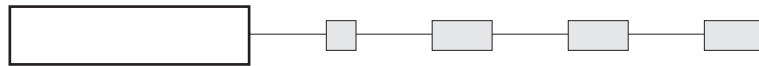

Shown in function 2, with standard plunger

Straight PC terminals : TP..P0



Single pole Double pole

TP32P0 TP42P0

TP33P0 TP43P0



ON



MOM

MOM

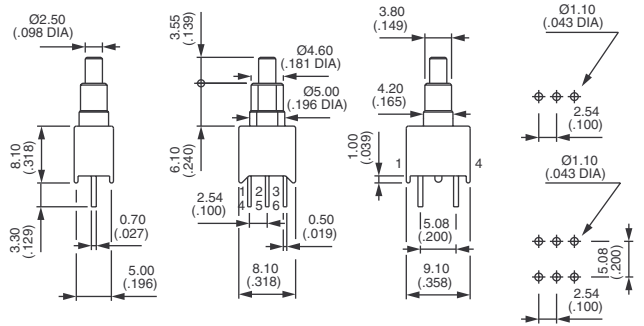

Function 3 has two terminals only (3 and 1) per pole

Straight terminals - bracket mounting : TP..Y0



Single pole Double pole

TP32Y0 TP42Y0

TP33Y0 TP43Y0



ON



MOM

OFF

MOM

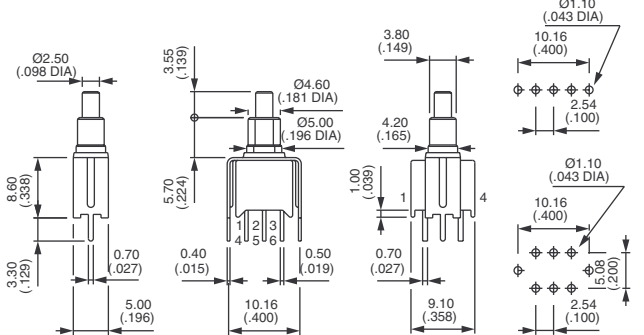

Function 3 has two terminals only (3 and 1) per pole

Right angle terminals - horizontal mounting : TP..W0



Single pole Double pole

TP32W0 TP42W0

TP33W0 TP 43W0



ON



MOM

OFF

MOM

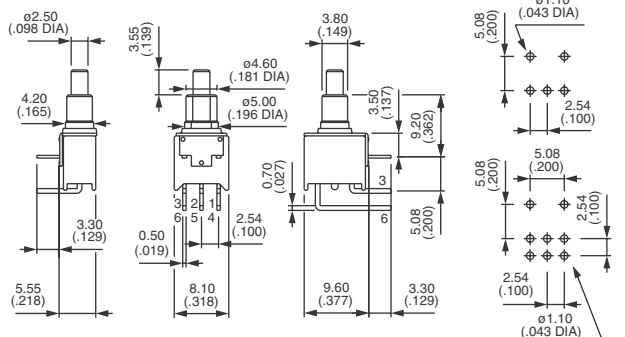

Function 3 has two terminals only (3 and 1) per pole

TP SERIES

SUBMINIATURE WASHABLE MOMENTARY PUSHBUTTON SWITCHES

M O D E L
S T R U C T U R E

Shown in function 2, with standard plunger

Right angle terminals - vertical mounting : TP..WW



Single pole	Double pole		
TP32WW	TP42WW	ON	MOM
TP33WW	TP43WW	OFF	MOM

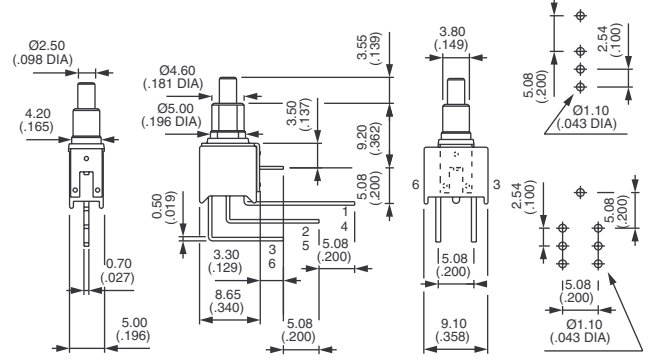

Function 3 has two terminals only (3 and 1) per pole

Wire-wrap terminals : TP..MW



Single pole	Double pole		
TP32MW	TP42MW	ON	MOM
TP33MW	TP43MW	OFF	MOM

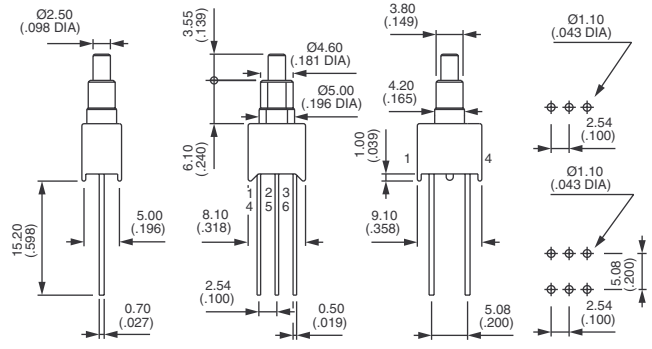

Function 3 has two terminals only (3 and 1) per pole

PCB MOUNTING

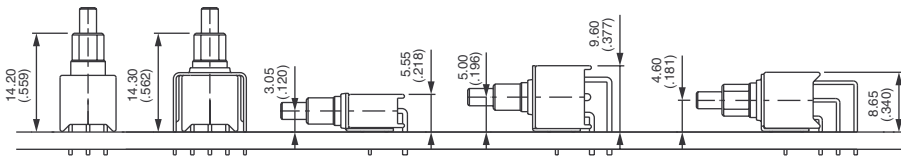

TP SERIES

SUBMINIATURE WASHABLE MOMENTARY PUSHBUTTON SWITCHES

OPTIONS

A

CONTACT AND TERMINAL MATERIALS

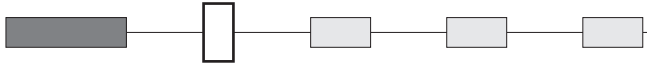

- 0 Brass, gold plated
- 1 Brass, silver plated
- 3 Brass, gold plated (1,27 micron gold)
- 8 Contact brass, gold plated + tin plated terminals
- 9 Contact brass, gold plated (1,27 micron gold) + tin plated terminals

PLUNGERS



Standard plunger colour is black.

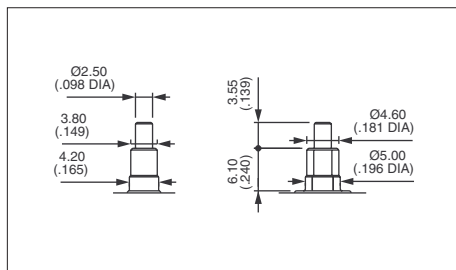

Short - standard

With blue
case
30

With black
case
80

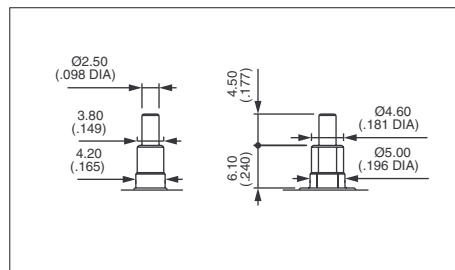

Long

With blue
case
35

With black
case
85

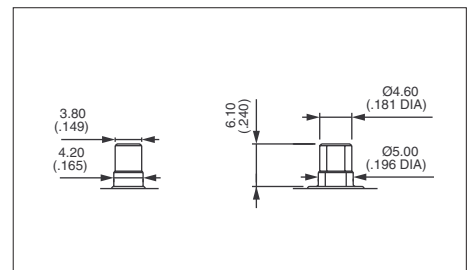

Flush

With black
case
82

SPECIAL OPTIONS

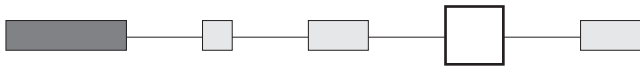

- 00 No special requirement
- 07 **Trimmed terminals** - length 3,2 mm (.125) for TP..WW models only
- 08 **Extended terminals** for TP..WO models only

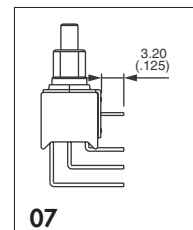

07

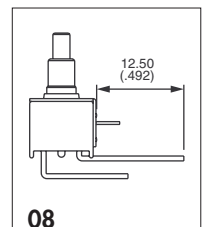

08

TP SERIES

SUBMINIATURE WASHABLE MOMENTARY PUSHBUTTON SWITCHES

OPTIONS



SPECIAL OPTIONS (continued)

- 18** Switch **without ground plate** for TP..WW models only
- 20** **Ground plate with 2 pins** for TP..WW models only
- 25** **Trimmed terminals** - length 5 mm (.196) for all models, except TP..WW
- 30** **Wire-wrap terminals** on models with mounting **bracket**
- 40** With cap U3500 mounted over plunger and bushing
Further protects the switch during PCB processing
- 50** **Crimping of ground plate pins.**
Retains switch on PC during handling and wave soldering.
For models TP..WO, TP..WW and TP..YO single and double pole.

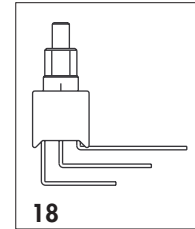

18

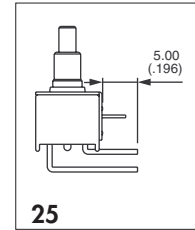

25

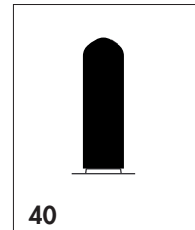

40

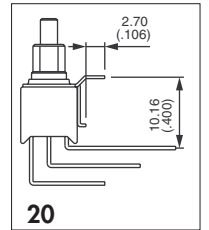

20

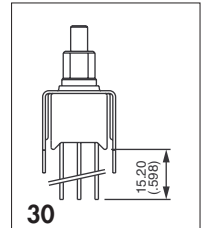

30

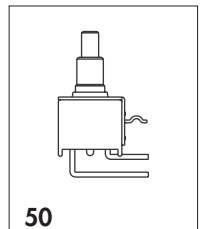

50

CAPS

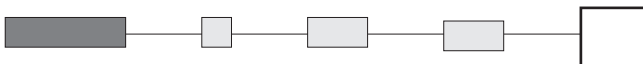

Blank Without cap

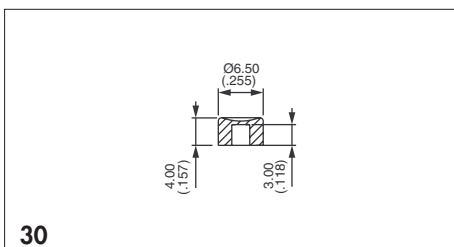

30

P/N U4310 - for long plunger only

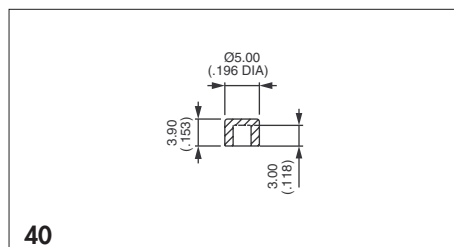

40

P/N U4320 - for long plunger only

To order caps separately, use their part number (U...).

Cap colours

Replace "0" by number

- 1** blue
- 2** black
- 3** green
- 4** grey
- 5** yellow
- 6** red
- 7** ivory
- 7/1** white
- 9** orange