

NAIS

SMALL POLARIZED RELAY WITH HIGH SENSITIVITY

TF-RELAYS

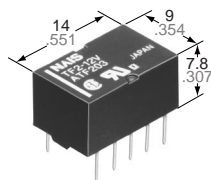

mm inch

FEATURES

- **High sensitivity:**
80 mW Nominal operating power (Single side stable 3-12 V type)
- **Surge voltage withstand: 1500 V FCC Part 68**

- **Minimal magnetic interference allows high density mounting**
- **Sealed construction allows automatic cleaning**
- **Self-clinching terminal also available**

SPECIFICATIONS

Contact

Arrangement	2 Form C	
Initial contact resistance, max. (By voltage drop 6 V DC 1 A)	50 mΩ	
Contact material	Gold-clad silver	
Rating	Nominal switching capacity (resistive load)	1 A 30 V DC, 0.5 A 125 V AC
	Max. switching power (resistive load)	30 W, 62.5 VA
	Max. switching voltage	110 V DC, 125 V AC
	Max. switching current	1 A
	Min. switching capacity ※1	10 μA 10 mV DC
Nominal operating power	Single side stable	80 mW (3 to 12 V DC) 140 mW (24 V DC) 260 mW (48 V DC)
	1 coil latching	55 mW (3 to 12 V DC) 100 mW (24 V DC)
	2 coil latching	110 mW (3 to 12 V DC) 200 mW (24 V DC)
Expected life (min. operations)	Mechanical (at 180 cpm)	10 ⁸
	Electrical (at 20 cpm)	1 A 30 V DC resistive load 2×10 ⁵
		0.5 A 125 V AC resistive load 10 ⁵

Note:

※1 This value can change due to the switching frequency, environmental conditions, and desired reliability level, therefore it is recommended to check this with the actual load.

Characteristics

Initial insulation resistance*1		Min. 1,000 MΩ (at 500 V DC)
Initial breakdown voltage	Between open contacts	750 Vrms for 1 min. (Detection current: 10 mA)
	Between contact and coil	1,000 Vrms for 1 min. (Detection current: 10 mA)
	Between contact sets	1,000 Vrms for 1 min. (Detection current: 10 mA)
FCC surge voltage between open contacts		1,500 V
Temperature rise*2 (at 20°C)		Max. 50°C
Operate time [Set time]*3 (at 20°C)		Max. 4 ms (Approx. 2 ms) [Max. 4 ms (Approx. 2 ms)]
Release time [Reset time]*4 (at 20°C)		Max. 4 ms (Approx. 1 ms) [Max. 4 ms (Approx. 2 ms)]
Shock resistance	Functional*5	Min. 490 m/s ² {50 G}
	Destructive*6	Min. 980 m/s ² {100 G}
Vibration resistance	Functional*7	176.4 m/s ² {18G}, 10 to 55 Hz at double amplitude of 3 mm
	Destructive	294 m/s ² {30G}, 10 to 55 Hz at double amplitude of 5 mm
Conditions for operation, transport and storage*8 (Not freezing and condensing at low temperature)	Ambient temperature	-40°C to +70°C -40°F to +158°F
	Humidity	5 to 85% R.H.
Unit weight		Approx. 2 g .071 oz

Remarks

- * Specifications will vary with foreign standards certification ratings.
- *1 Measurement at same location as "Initial breakdown voltage" section.
- *2 By resistive method, nominal voltage applied to the coil; contact carrying current: 1 A.
- *3 Nominal voltage applied to the coil, excluding contact bounce time.
- *4 Nominal voltage applied to the coil, excluding contact bounce time without diode.
- *5 Half-wave pulse of sine wave: 11 ms; detection time: 10 μs.
- *6 Half-wave pulse of sine wave: 6 ms.
- *7 Detection time: 10 μs.
- *8 Refer to 4. Conditions for operation, transport and storage mentioned in Cautions for use (Page 178).

ORDERING INFORMATION

Ex. TF 2 — L — H — 3V

Contact arrangement	Operating function	Terminal shape	Coil voltage(DC)
2:2 Form C	Nil: Single side stable L: 1 coil latching L2: 2 coil latching	Nil: Standard PC board terminal H: Self-clinching terminal	3,4,5,5,6,9,12, 24,48 ^V

^{48 V coil type: Single side stable only}

Note: AgPd stationary contact types available for high resistance against contact sticking. When ordering, please add suffix "-3" like TF2-12V-3.

TYPES AND COIL DATA (at 20°C 68°F)

1. Single side stable

Part No.		Nominal voltage, V DC	Pick-up voltage, V DC (max.)	Drop-out voltage, V DC (min.)	Nominal operating current, mA (±10%)	Coil resistance, Ω (±10%)	Nominal operating power, mW	Max. allowable voltage, V DC
Standard PC board terminal	Self-clinching terminal							
TF2-3 V	TF2-H-3 V	3	2.25	0.3	26.7	112.5	80	4.5
TF2-4.5 V	TF2-H-4.5 V	4.5	3.38	0.45	17.8	253	80	6.7
TF2-5 V	TF2-H-5 V	5	3.75	0.5	16	312.5	80	7.5
TF2-6 V	TF2-H-6 V	6	4.5	0.6	13.3	450	80	9
TF2-9 V	TF2-H-9 V	9	6.75	0.9	8.9	1,012.5	80	13.5
TF2-12 V	TF2-H-12 V	12	9	1.2	6.7	1,800	80	18
TF2-24 V	TF2-H-24 V	24	18	2.4	5.8	4,100	140	36
TF2-48 V	TF2-H-48 V	48	36	4.8	5.4	8,860	260	57.6

2. 1 Coil latching

Part No.		Nominal voltage, V DC	Set voltage, V DC (max.)	Reset voltage, V DC (max.)	Nominal operating current, mA (±10%)	Coil resistance, Ω (±10%)	Nominal operating power, mW	Max. allowable voltage, V DC
Standard PC board terminal	Self-clinching terminal							
TF2-L-3 V	TF2-L-H-3 V	3	2.25	2.25	18.3	163.6	55	4.5
TF2-L-4.5 V	TF2-L-H-4.5 V	4.5	3.38	3.38	12.2	368.2	55	6.7
TF2-L-5 V	TF2-L-H-5 V	5	3.75	3.75	11	454.5	55	7.5
TF2-L-6 V	TF2-L-H-6 V	6	4.5	4.5	9.2	654.5	55	9
TF2-L-9 V	TF2-L-H-9 V	9	6.75	6.75	6.1	1,472	55	13.5
TF2-L-12 V	TF2-L-H-12 V	12	9	9	4.6	2,618	55	18
TF2-L-24 V	TF2-L-H-24 V	24	18	18	4.2	5,760	100	36

3. 2 Coil latching

Part No.		Nominal voltage, V DC	Set voltage, V DC (max.)	Reset voltage, V DC (max.)	Nominal operating current, mA (±10%)	Coil resistance, Ω (±10%)	Nominal operating power, mW	Max. allowable voltage, V DC
Standard PC board terminal	Self-clinching terminal							
TF2-L2-3 V	TF2-L2-H-3 V	3	2.25	2.25	36.7	81.8	110	4.5
TF2-L2-4.5 V	TF2-L2-H-4.5 V	4.5	3.38	3.38	24.4	184.1	110	6.7
TF2-L2-5 V	TF2-L2-H-5 V	5	3.75	3.75	22	227.3	110	7.5
TF2-L2-6 V	TF2-L2-H-6 V	6	4.5	4.5	18.3	327.3	110	9
TF2-L2-9 V	TF2-L2-H-9 V	9	6.75	6.75	12.2	736.4	110	13.5
TF2-L2-12 V	TF2-L2-H-12 V	12	9	9	9.2	1,309	110	18
TF2-L2-24 V	TF2-L2-H-24 V	24	18	18	8.3	2,880	200	36

Notes:

1. Specified value of the pick-up, drop-out, set and reset voltage is with the condition of square wave coil pulse.
2. Standard packing: Tube: 50 pcs.; Case: 1,000 pcs.
3. In case of 5 V drive circuit, it is recommended to use 4.5 V type relay.
4. AgPd stationary contact types available for high resistance against contact sticking. When ordering, please add suffix "-3" like TF2-12V-3.

DIMENSIONS

mm inch

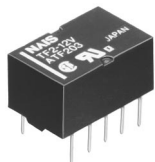

Standard PC board terminal

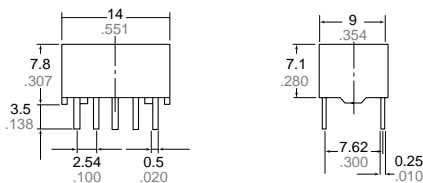

PC board pattern (Copper-side view)

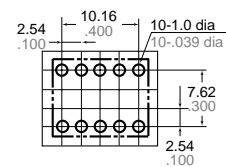

Tolerance: ±0.1 ±.004

Self-clinching terminal

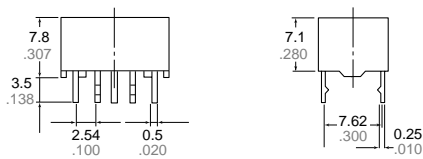

Single side stable (Deenergized condition)

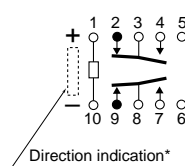

Schematic (Bottom view)

1-coil latching (Reset condition)

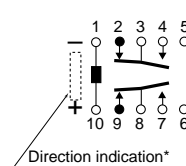

2-coil latching (Reset condition)

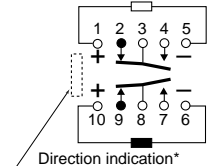

General tolerance: ±0.3 ±.012

*Orientation stripe typical-located on top of relay.

REFERENCE DATA

1. Maximum switching capacity

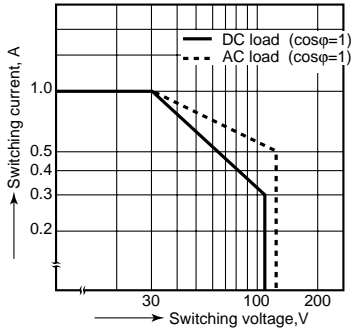

2. Life curve

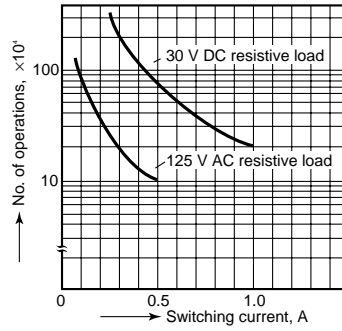

3. Mechanical life

Tested sample: TF2-12V, 10 pcs.

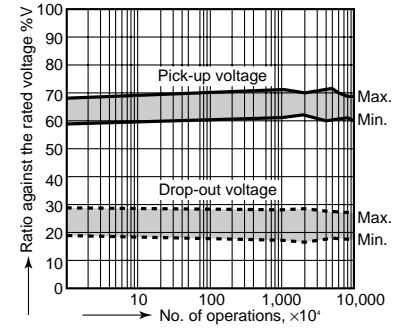

4.-(1) Electrical life (DC load)

Tested sample: TF2-12V, 6 pcs.

Condition: 1 A 30 V DC resistive load, 20 cpm

Change of pick-up and drop-out voltage

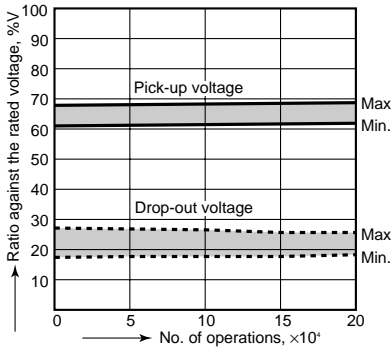

Change of contact resistance

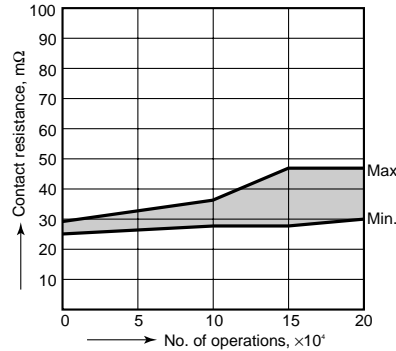

4.-(2) Electrical life (AC load)

Tested sample: TF2-12V, 6 pcs

Condition: 0.5 A 125 V AC resistive load, 20 cpm

Change of pick-up and drop-out voltage

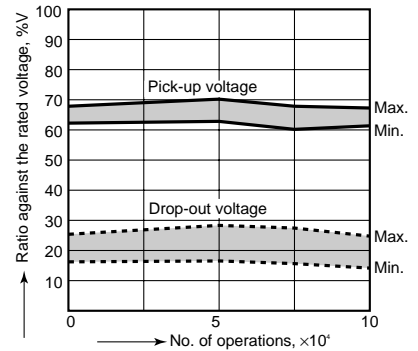

5. Coil temperature rise

Tested sample: TF2-xxV

Measured portion: Inside the coil

Ambient temperature: 30°C 86°F

Change of contact resistance

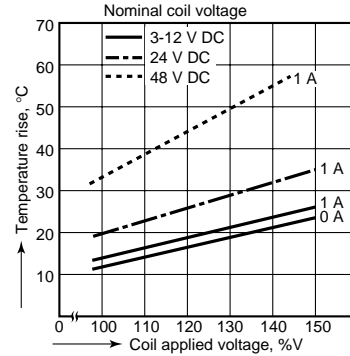
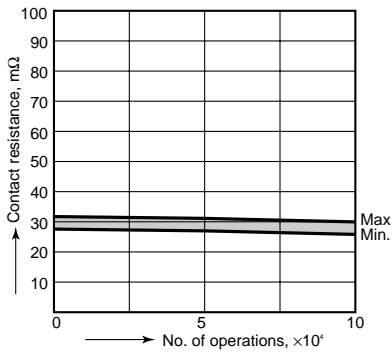

6. Operate/release time characteristics

Tested sample: TF2-12V, 5 pcs.

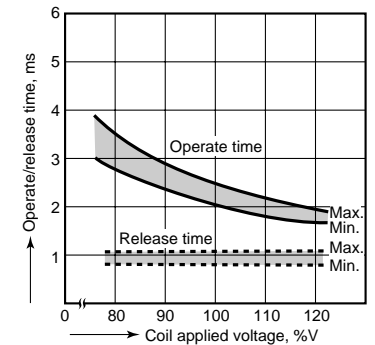

7. Set/reset time characteristics

Tested sample: TF2-L2-12V, 5 pcs.

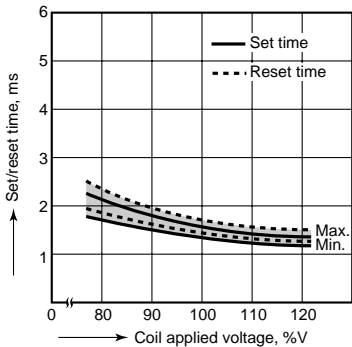

8. Distribution of pick-up and drop-out voltage

Tested sample: TF2-12V, 50 pcs.

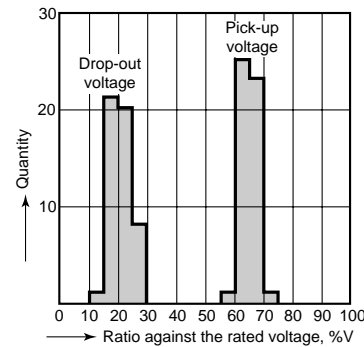

9. Distribution of set and reset voltage

Tested sample: TF2-L2-12V, 20 pcs.

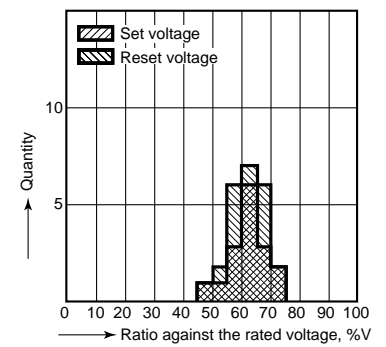

10. Ambient temperature characteristics
Tested sample: TF2-12V, 5 pcs.

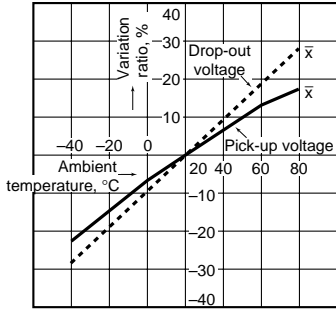

11. Distribution of contact resistance
Tested sample: TF2-12V, 30 pcs. (30, ×4 contacts)

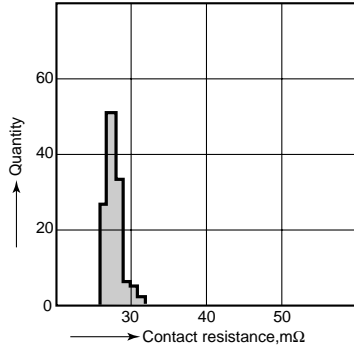

12.-(1) High-frequency characteristics
Tested sample: TF2-xxV
Isolation characteristics

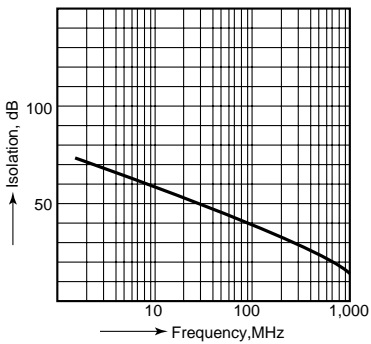

12.-(2) High-frequency characteristics
Tested sample: TF2-xxV
Insertion loss characteristics

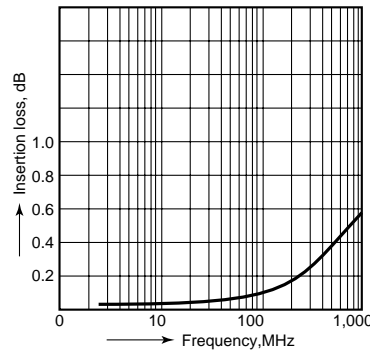

12.-(3) High-frequency characteristics
Tested sample: TF2-xxV
V.S.W.R.

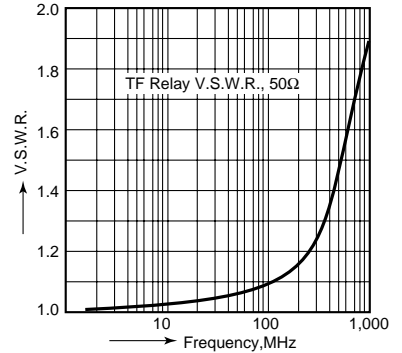

13.-(1) Malfunctional shock (single side stable)
Tested sample: TF2-12V, 6 pcs

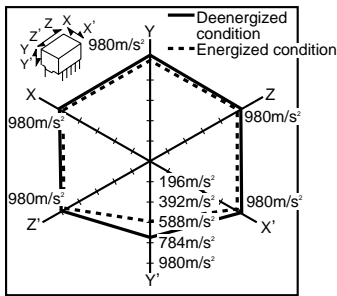

13.-(2) Malfunctional shock (latching)
Tested sample: TF2-L-12V, 6 pcs.

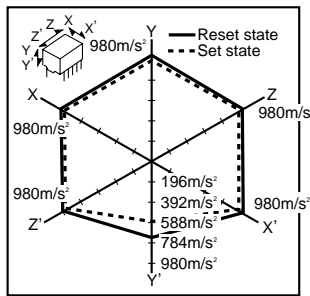

14.-(1) Influence of adjacent mounting

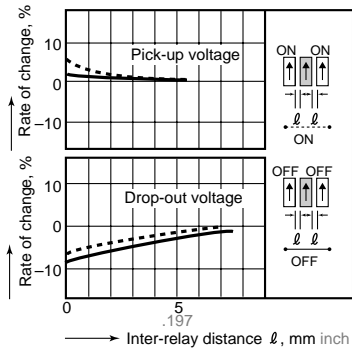

14.-(2) Influence of adjacent mounting

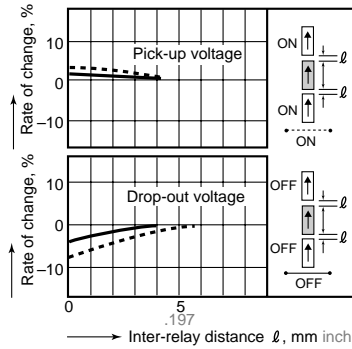

14.-(3) Influence of adjacent mounting

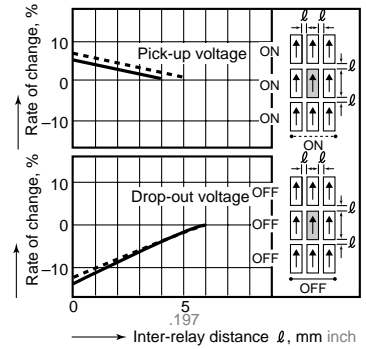

15. Actual load test
 Tested sample: TF2-12V
 (35 mA 48 V DC wire spring relay load)

Change of pick-up and drop-out voltage

Change of contact resistance

Circuit

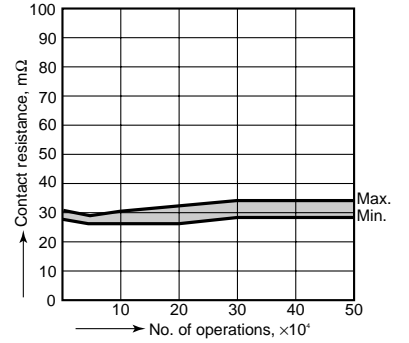
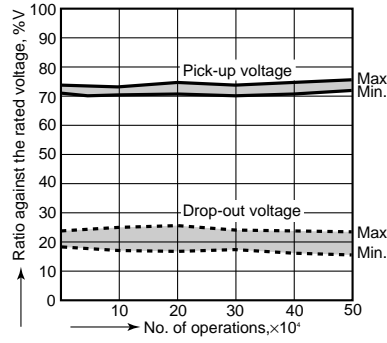
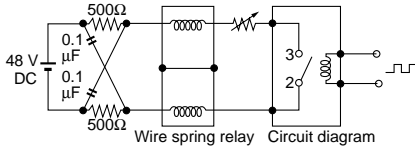

For Cautions for Use, see Relay Technical Information

T-Series Relays

T series Cautions for Use

1. Coil operating power

Pure DC current should be applied to the coil. The wave form should be rectangular. If it includes ripple, the ripple factor should be less than 5%.

However, check it with the actual circuit since the characteristics may be slightly different.

The nominal operating voltage should be applied to the coil for more than 10 ms to set/reset the latching type relay.

2. Coil connection

When connecting coils, refer to the wiring diagram to prevent mis-operation or malfunction.

3. External magnetic field

Since T-Series relays are highly sensitive polarized relays, their characteristics will be affected by a strong external magnetic field.

Avoid using the relay under that conditions.

4. Conditions for operation, transport and storage

1) Ambient temperature, humidity, and atmospheric pressure during usage, transport, and storage of the relay:

TX(-SMD)/TX-D(-SMD)/TQ-SMD

(1) Temperature:

-40 to +85°C -40 to +185°F.

The temperature range is -40 to +70°C

-40 to +158°F for the packaged relay.

TX-S(-SMD)

(1) Temperature:

-40 to +70°C -40 to +158°F. for the package/non-package relay.

(2) Humidity: 5 to 85% R.H.

TQ/TF/TN/TK

(1) Temperature: -40 to +70°C -40 to

+158°F

The temperature range is -40 to +60°C

-40 to +140°F for the packaged relay.

(2) Humidity: 5 to 85% R.H.

(Avoid freezing and condensation.)

The humidity range varies with the temperature.

Use within the range indicated in the graph below.

(3) Atmospheric pressure: 86 to 106 kPa

Temperature and humidity range for usage, transport, and storage:

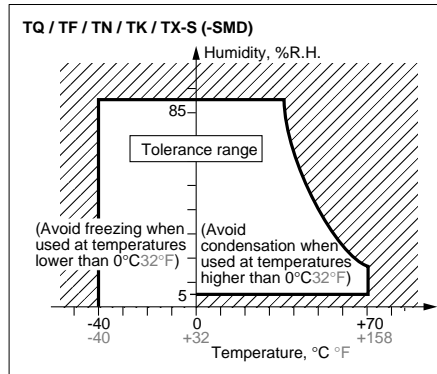

2) Condensation

Condensation forms when there is a sudden change in temperature under high temperature, high humidity conditions. Condensation will cause deterioration of the relay insulation.

3) Freezing

Condensation or other moisture may freeze on the relay when the temperature is lower than 0°C 32°F.

This causes problems such as sticking of movable parts or operational time lags.

4) Low temperature, low humidity environments

The plastic becomes brittle if the relay is exposed to a low temperature, low humidity environment for long periods of time.

5. M.B.B. contact relays

A small OFF time may be generated by the contact bounce during contact switching. Check the actual circuit carefully. If the relay is dropped accidentally, check the appearance and characteristics including M.B.B. time before use.

6. Packing style

1) Tube orientation for both standard through hole terminal type (including self-clinching type) and surface-mount terminal type.

The relay is packed in a tube with the relay orientation mark on the left side, as shown in the figure below.

Take note of the relay orientation when mounting relays on the printed circuit board.

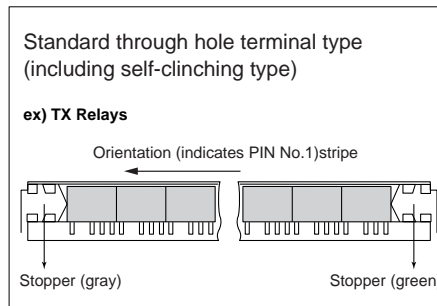

Surface-mount terminal type

ex) TX-SMD Relays

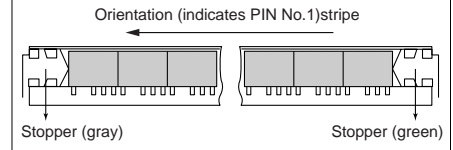

(2) Tape and reel packing (surface-mount terminal type)

(1) Tape dimensions

1. TX/TX-D/TX-S-SMD Relays

(i) SA type

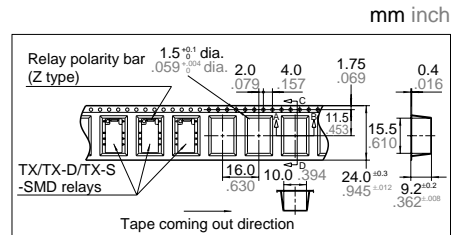

(ii) SL type

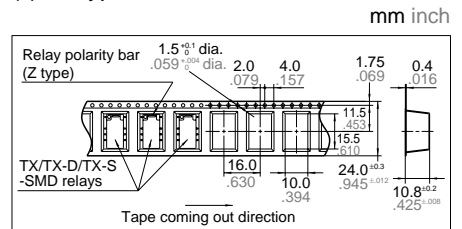

(iii) SS type

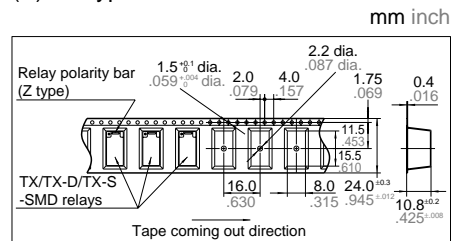

2. TQ-SMD Relays

(i) SA type

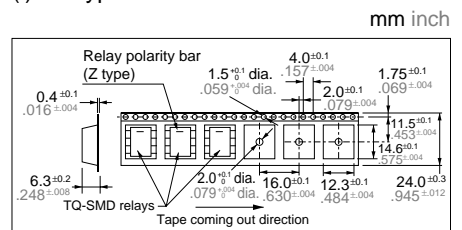

(ii) SL, SS type

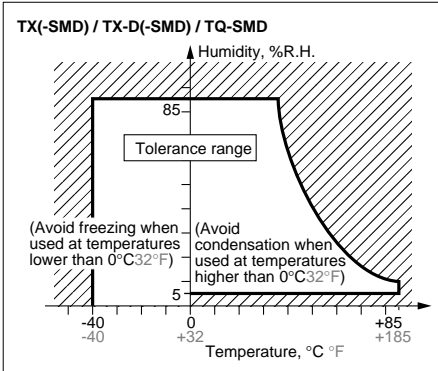
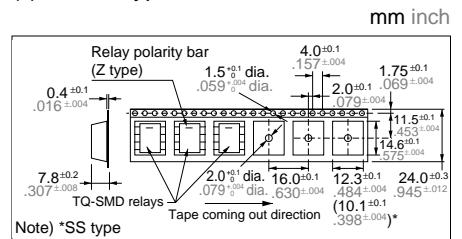

(2) Dimensions of plastic reel

(i) TX/TX-D/TX-S-SMD Relays

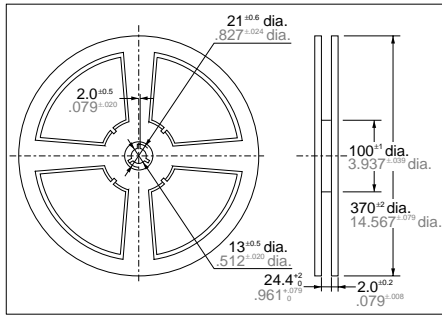

(ii) TQ-SMD Relays

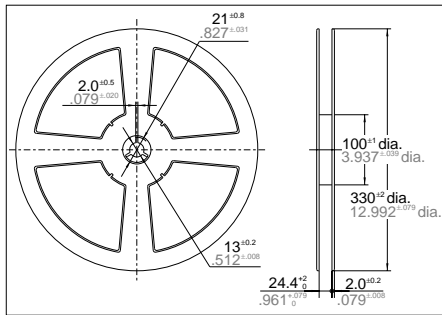

7. Automatic insertion

To maintain the internal function of the relay, the chucking pressure should not exceed the values below.

1) TX(-SMD)/TX-D(-SMD)/TQ/TF

Chucking pressure in the direction A:

4.9 N {500 g} or less

Chucking pressure in the direction B:

9.8 N {1 kg} or less

Chucking pressure in the direction C:

9.8 N {1 kg} or less

TX(-SMD)/TX-D(-SMD)/TX-S(-SMD)

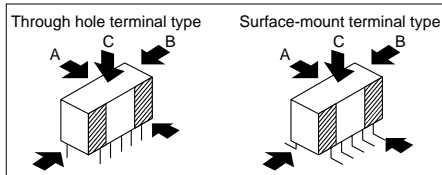

TQ

TF

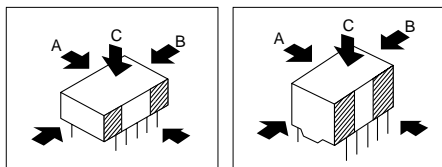

Please chuck the portion.

Avoid chucking the center of the relay.

2) TQ-SMD

Chucking pressure in the direction A:

9.8 N {1 kg} or less

Chucking pressure in the direction B:

9.8 N {1 kg} or less

Mounting pressure in the direction C:

9.8 N {1 kg} or less

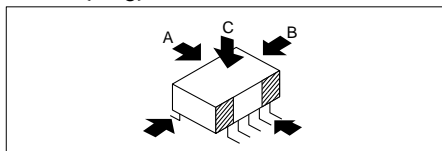

Please chuck the portion.

Avoid chucking the center of the relay.

3) TN

Chucking pressure in the direction A:

9.8 N {1 kg} or less

Chucking pressure in the direction B:

9.8 N {1 kg} or less

Chucking pressure in the direction C:

4.9 N {500 g} or less

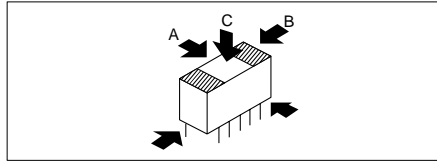

Please chuck the portion.

Avoid chucking the center of the relay.

4) TK

Chucking pressure* in the direction A:

9.8 N {1 kg} or less

Chucking pressure* in the direction B:

29.4 N {3 kg} or less

Chucking pressure* in the direction C:

9.8 N {1 kg} or less

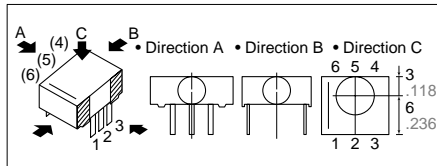

Please chuck the portion.

Avoid chucking the center of the relay.

*Value of chucking pressure is shown by the value of weight pressed on the portion(4 mm dia.)

8. Soldering

1) Preheat according to the following conditions.

Temperature	100°C 212°F or less
Time	Within approx. 1 minute

When soldering standard PC board terminals or self-clinching terminals, soldering should be done at 250°C 482°F within 5 sec.

2) When soldering surface-mount terminals, the following conditions are recommended.

(1) IR (Infrared reflow) soldering method

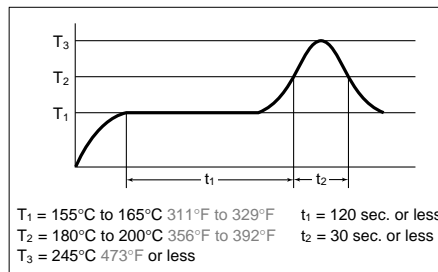

(2) Vapor phase soldering method

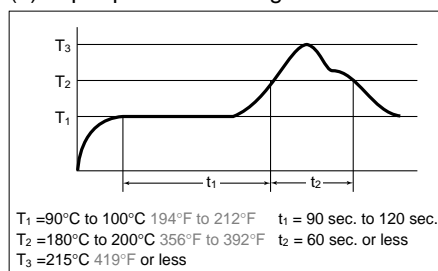

(3) Soldering iron method

Tip temperature: 280°C to 300°C 536°F to 572°C

Wattage: 30 to 60 W

Soldering time: within 5 sec.

(4) Other soldering methods

Check mounting conditions before using other soldering methods (hot-air, hot plate, pulse heater, etc.).

Remarks

The temperature profile indicates the temperature of the soldered terminal on the surface of the PC board.

The ambient temperature may increase excessively.

Check the temperature under mounting conditions.

The conditions for the infrared reflow soldering apply when preheating using the VPS method.

9. Cleaning

In automatic cleaning, cleaning with the boiling method is recommended. Avoid ultrasonic cleaning which subject the relay to high frequency vibrations. It may cause the contacts to stick.

It is recommended that a fluorinated hydrocarbon or other alcoholic solvents be used.

10. Others

1) If in error the relay has been dropped, the appearance and characteristics should be checked before use without fail.

2) The cycle lifetime is defined under the standard test condition specified in the JIS* C 5442-1986 standard (temperature 15 to 35°C 59 to 95°F, humidity 25 to 85%). Check this with the real device as it is affected by coil driving circuit, load type, activation frequency, activation phase, ambient conditions and other factors.

3) For secure operations, the voltage applied to the coil should be nominal voltage. In addition, please note that pick-up and drop-out voltage will vary according to the ambient temperature and operation conditions.

4) Latching relays are shipped from the factory in the reset state. A shock to the relay during shipping or installation may cause it to change to the set state.

Therefore, it is recommended that the relay be used in a circuit which initializes the relay to the required state (set or reset) whenever the power is turned on.

5) Check the ambient conditions when storing or transporting the relays and devices containing the relays. Freezing or condensation may occur in the relay, causing functional damage. Avoid subjecting the relays to heavy loads, or strong vibration and shocks.

*Japanese Industrial Standards