

T599, Tantalum, Polymer Tantalum, 47 uF, 20%, 4 VDC, SMD, Polymer, Molded, Low ESR, AEC-Q200, 70 mOhms, 3528, Height Max = 2.1mm

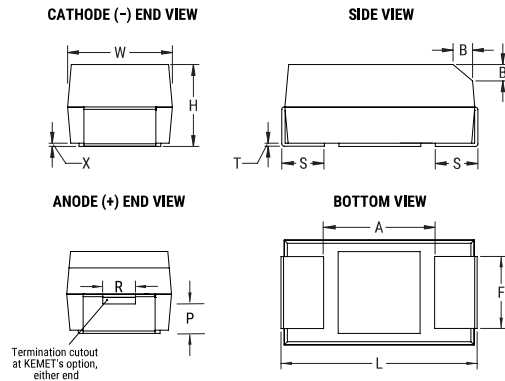

Dimensions	
Footprint	3528
L	3.5mm +/-0.2mm
W	2.8mm +/-0.2mm
H	1.9mm +/-0.2mm
T	0.13mm REF
S	0.8mm +/-0.3mm
F	2.2mm +/-0.1mm
A	1.1mm MIN
B	0.4mm +/-0.15mm
P	0.5mm REF
R	1mm REF
X	0.1mm +/-0.1mm

Packaging Specifications	
Packaging:	T&R, 178mm
Packaging Quantity:	2000

General Information	
Series:	T599
Dielectric:	Polymer Tantalum
Style:	SMD Chip
Description:	SMD, Polymer, Molded, Low ESR, AEC-Q200
Features:	Automotive
RoHS:	Yes
Termination:	Tin
Qualifications:	AEC-Q200
AEC-Q200:	Yes
Component Weight:	94.85 mg
Shelf Life:	52 Weeks
MSL:	3

Specifications	
Capacitance:	47 uF
Capacitance Tolerance:	20%
Voltage DC:	4 VDC (105C), 2.68 VDC (150C)
Temperature Range:	-55/+150°C
Rated Temperature:	105°C
Humidity:	85C, 85% RH, load, 1000 Hours
Dissipation Factor:	8% 120Hz 25C
Failure Rate:	N/A
Resistance:	70 mOhms (100kHz 25C)
Ripple Current:	1390 mA (rms, 100kHz 45C), 973 mA (rms, 125C), 347.5 mA (rms, 150C)
Leakage Current:	18.8 uA (5min 25°C)

Statements of suitability for certain applications are based on our knowledge of typical operating conditions for such applications, but are not intended to constitute - and we specifically disclaim - any warranty concerning suitability for a specific customer application or use. This Information is intended for use only by customers who have the requisite experience and capability to determine the correct products for their application. Any technical advice inferred from this Information or otherwise provided by us with reference to the use of our products is given gratis, and we assume no obligation or liability for the advice given or results obtained.