

T520, Tantalum, Polymer Tantalum, 220 uF, 20%, 4 VDC, SMD, Polymer, Molded, Low Profile/ESR, NonCombustible, 15 mOhms, 7343, Height Max = 1.9mm

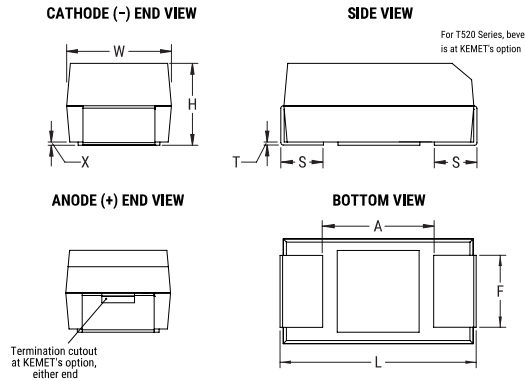

Dimensions	
Footprint	7343
L	7.3mm +/-0.3mm
W	4.3mm +/-0.3mm
H	1.8mm +/-0.1mm
T	0.13mm REF
S	1.3mm +/-0.3mm
F	2.4mm +/-0.1mm
A	3.6mm MIN
X	0.05mm REF

Packaging Specifications	
Packaging:	T&R, 178mm
Packaging Quantity:	1000

General Information	
Series:	T520
Dielectric:	Polymer Tantalum
Style:	SMD Chip
Description:	SMD, Polymer, Molded, Low Profile/ESR, NonCombustible
Features:	Low ESR
RoHS:	Yes
Termination:	Tin
AEC-Q200:	No
Component Weight:	274.3 mg
Shelf Life:	52 Weeks
MSL:	3

Specifications	
Capacitance:	220 uF
Capacitance Tolerance:	20%
Voltage DC:	4 VDC (105C)
Temperature Range:	-55/+105°C
Rated Temperature:	105°C
Life:	2000 Hrs (105C)
Humidity:	60C, 90% RH, 500 Hours, No Load
Dissipation Factor:	10% 120Hz 25C
Failure Rate:	N/A
Resistance:	15 mOhms (100kHz 25C)
Ripple Current:	3500 mA (rms, 100kHz 45C), 2450 mA (rms, 85C), 875 mA (rms, 105C)
Leakage Current:	88 uA (5min 25°C)

Statements of suitability for certain applications are based on our knowledge of typical operating conditions for such applications, but are not intended to constitute - and we specifically disclaim - any warranty concerning suitability for a specific customer application or use. This Information is intended for use only by customers who have the requisite experience and capability to determine the correct products for their application. Any technical advice inferred from this Information or otherwise provided by us with reference to the use of our products is given gratis, and we assume no obligation or liability for the advice given or results obtained.