

T491, Tantalum, MnO2 Tantalum, 2.2 uF, 20%, 16 VDC, SMD, MnO2, Molded, 6 Ohms, 3216, Height Max = 1.8mm

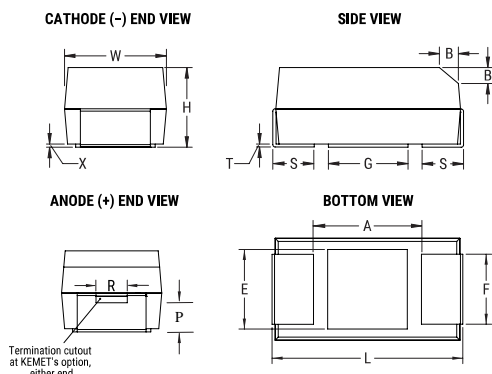

General Information	
Series:	T491
Dielectric:	MnO2 Tantalum
Style:	SMD Chip
Description:	SMD, MnO2, Molded
RoHS:	Yes
Termination:	Tin
AEC-Q200:	No
Component Weight:	58.6 mg
Shelf Life:	156 Weeks
MSL:	1

Dimensions	
Footprint	3216
L	3.2mm +/-0.2mm
W	1.6mm +/-0.2mm
H	1.6mm +/-0.2mm
T	0.13mm REF
S	0.8mm +0.2/-0.3mm
F	1.2mm +/-0.1mm
A	1.2mm MIN
B	0.4mm +/-0.15mm
E	1.3mm REF
G	1.1mm REF
P	0.4mm REF
R	0.4mm REF
X	0.1mm +/-0.1mm

Specifications	
Capacitance:	2.2 uF
Capacitance Tolerance:	20%
Voltage DC:	16 VDC (85C), 10.72 VDC (125C)
Temperature Range:	-55/+125°C
Rated Temperature:	85°C
Dissipation Factor:	6% 120Hz 25C
Failure Rate:	N/A
Resistance:	6 Ohms (100kHz 25C)
Ripple Current:	112 mA (rms, 100kHz 25C), 100.8 mA (rms, 85C), 44.8 mA (rms, 125C)
Leakage Current:	0.5 uA (5min 25°C)

Packaging Specifications	
Packaging:	T&R, 178mm
Packaging Quantity:	2000

Statements of suitability for certain applications are based on our knowledge of typical operating conditions for such applications, but are not intended to constitute - and we specifically disclaim - any warranty concerning suitability for a specific customer application or use. This Information is intended for use only by customers who have the requisite experience and capability to determine the correct products for their application. Any technical advice inferred from this Information or otherwise provided by us with reference to the use of our products is given gratis, and we assume no obligation or liability for the advice given or results obtained.