

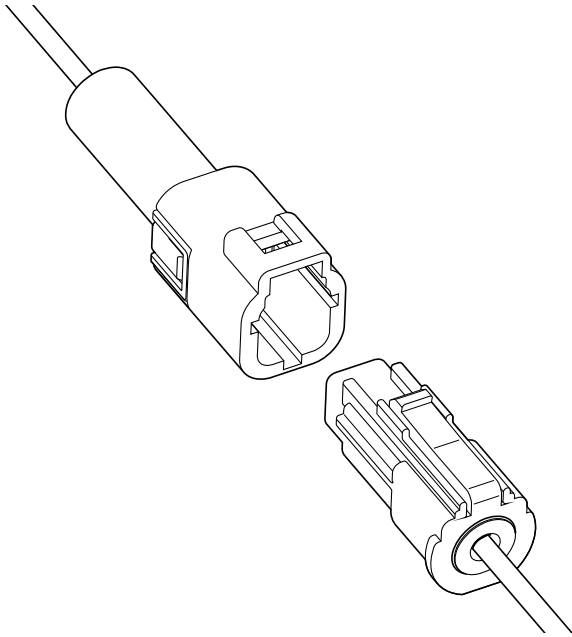

WPK CONNECTOR

Disconnectable Crimp style Wire-to-wire connectors (waterproof type)



This is wire-to-wire connector suitable for use in places where waterproof is especially required.

It is used for power connecting but compact, and has waterproof of grade 7 ingress protection of JIS C 0920 (IPX7 of IEC 60529) and excels in durability.

- Waterproof (ingress protection)
- Male housing has a built-in seal ring
- Compact design
- Inner-housing lock
- High durability and High reliability

Specifications

- Current rating: 7 A AC/DC (0.85 mm²)
- Voltage rating: 12 V AC/DC
- Temperature range: -40°C to +105°C
(including temperature rise in applying electrical current)
- Contact resistance: Initial value/ 5 mΩ max.
After environmental tests/ 10 mΩ max.
- Insulation resistance: 100 MΩ min.
- Withstanding voltage: 1,000 VAC/minute
- Applicable wire: 0.5 to 0.85 mm²
Insulation O.D./ 1.6 to 1.9 mm
- Waterproof grade: Grade 7 ingress protection of JIS C 0920 (IPX7 of IEC 60529)

* In using the products, refer to "Handling Precautions for Terminals and Connectors" described on our website (Technical documents of Product information page).

* RoHS2 compliance

* Dimensional unit: mm

* Contact JST for details.

Assembly layout

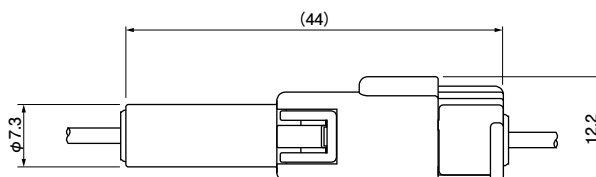

WPK CONNECTOR

Contact

Male contact

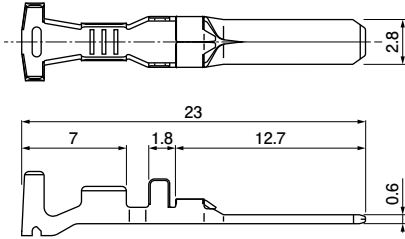

Female contact

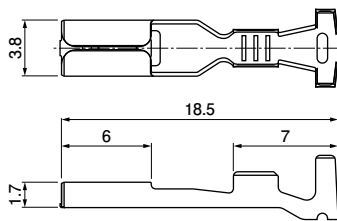

Model No.		Applicable wire (mm ²)	Insulation O.D. (mm)	Q'ty/reel
Male contact	Female contact			
SWPKP-21T-0.6	SWPKR-21T-0.6	0.5~0.85	1.6~1.9	3,000

Material and Finish

Copper alloy, tin-plated (reflow treatment)

RoHS2 compliance

Contact	Crimping machine	Applicator		
		Crimp applicator	Dies	Crimp applicator with dies
SWPKP-21T-0.6	AP-K2N	MKS-L	MK/SWPKP/R-21-06	APLMK SWPKP/R21-06
SWPKR-21T-0.6				

Note: Contact JST for fully automatic crimping applicator.

Male housing (for male contact)

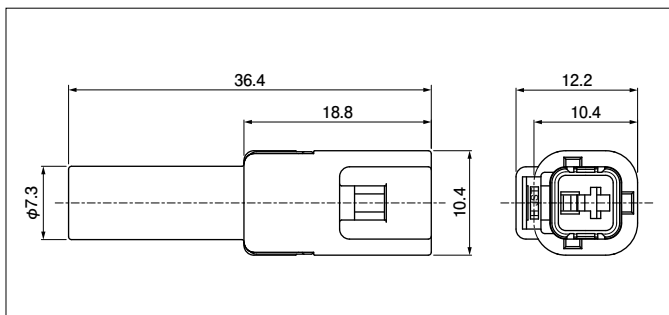

No. of circuits	Model No.	Q'ty/box
1	01P-WPKH-KN	100

Material and Finish

Housing: PBT, black
Seal ring: NBR, brown

RoHS2 compliance

Note: 01P-WPKH-KN has a built-in seal ring.

Female housing (for female contact)

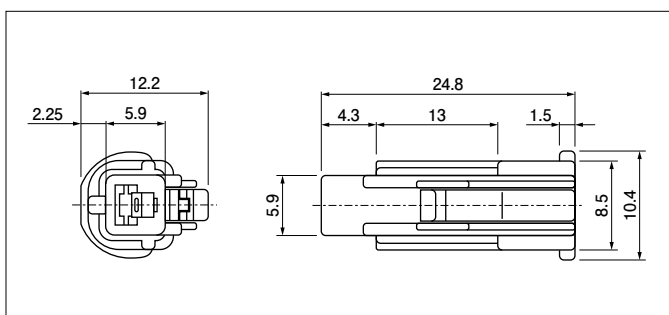

No. of circuits	Model No.	Q'ty/bag
1	WPKR-01H-K	1,000

Material and Finish

PBT, black

RoHS2 compliance

Wire end seal

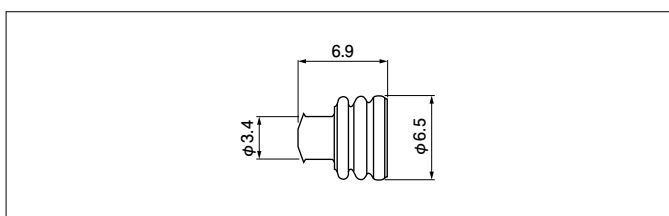

Model No.	Rubber inner diameter (mm)	Insulation O.D. (mm)	Q'ty/bag
WPKS-1.3N	1.3	1.6~1.9	1,500

Material and Finish

NBR, brown

RoHS2 compliance

Note: Contact JST for applicable wires.