

## Trench gate field-stop IGBT, HB series 650 V, 40 A high speed

Datasheet - production data

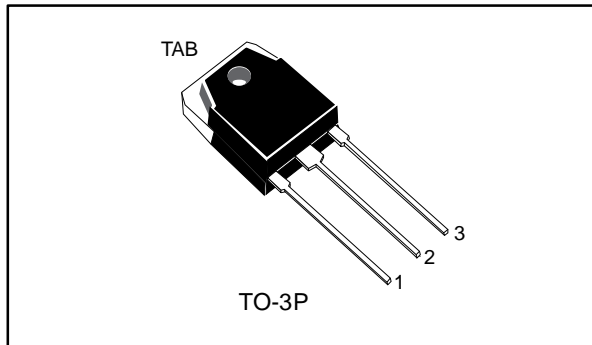
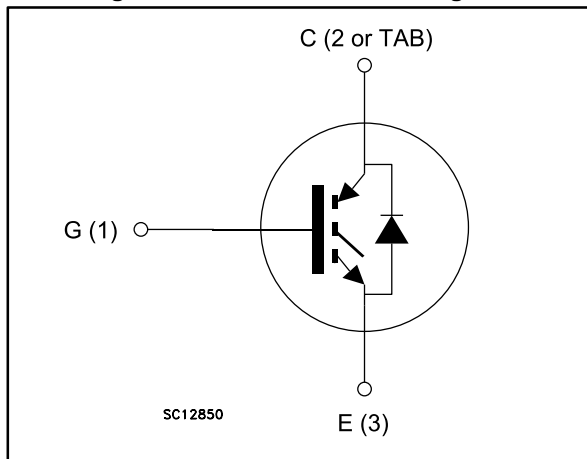


Figure 1: Internal schematic diagram



### Features

- Maximum junction temperature:  $T_J = 175\text{ °C}$
- Minimized tail current
- $V_{CE(sat)} = 1.6\text{ V (typ.) @ } I_C = 40\text{ A}$
- Tight parameter distribution
- Co-packed diode for protection
- Safe paralleling
- Low thermal resistance

### Applications

- Power factor corrector (PFC)

### Description

This device is an IGBT developed using an advanced proprietary trench gate field-stop structure. The device is part of the new HB series of IGBTs, which represents an optimum compromise between conduction and switching loss to maximize the efficiency of any frequency converter. Furthermore, the slightly positive  $V_{CE(sat)}$  temperature coefficient and very tight parameter distribution result in safer paralleling operation.

Table 1: Device summary

Order code	Marking	Package	Packing
STGWT40HP65FB	GWT40HP65FB	TO-3P	Tube

---

## Contents

<b>1</b>	<b>Electrical ratings .....</b>	<b>3</b>
<b>2</b>	<b>Electrical characteristics .....</b>	<b>4</b>
	2.1 Electrical characteristics (curves).....	6
<b>3</b>	<b>Test circuits .....</b>	<b>12</b>
<b>4</b>	<b>Package information .....</b>	<b>13</b>
	4.1 TO-3P package information .....	14
<b>5</b>	<b>Revision history .....</b>	<b>16</b>

# 1 Electrical ratings

**Table 2: Absolute maximum ratings**

Symbol	Parameter	Value	Unit
$V_{CES}$	Collector-emitter voltage ( $V_{GE} = 0$ V)	650	V
$I_C$	Continuous collector current at $T_C = 25$ °C	80	A
	Continuous collector current at $T_C = 100$ °C	40	
$I_{CP}^{(1)}$	Pulsed collector current	160	A
$V_{GE}$	Gate-emitter voltage	$\pm 30$	V
$I_F^{(2)}$	Continuous forward current at $T_C = 25$ °C	5	A
	Continuous forward current at $T_C = 100$ °C	5	
$I_{FP}^{(3)}$	Pulsed forward current	10	A
$P_{TOT}$	Total dissipation at $T_C = 25$ °C	283	W
$T_{STG}$	Storage temperature range	- 55 to 150	°C
$T_J$	Operating junction temperature range	- 55 to 175	

**Notes:**

(1)Pulse width limited by maximum junction temperature.

(2)Limited by wires.

(3)Pulsed forward current.

**Table 3: Thermal data**

Symbol	Parameter	Value	Unit
$R_{thJC}$	Thermal resistance junction-case IGBT	0.53	°C/W
$R_{thJC}$	Thermal resistance junction-case diode	5	
$R_{thJA}$	Thermal resistance junction-ambient	50	

## 2 Electrical characteristics

$T_J = 25\text{ °C}$  unless otherwise specified

**Table 4: Static characteristics**

Symbol	Parameter	Test conditions	Min.	Typ.	Max.	Unit
$V_{(BR)CES}$	Collector-emitter breakdown voltage	$V_{GE} = 0\text{ V}$ , $I_C = 2\text{ mA}$	650			V
$V_{CE(sat)}$	Collector-emitter saturation voltage	$V_{GE} = 15\text{ V}$ , $I_C = 40\text{ A}$		1.6	2.0	V
		$V_{GE} = 15\text{ V}$ , $I_C = 40\text{ A}$ , $T_J = 125\text{ °C}$		1.7		
		$V_{GE} = 15\text{ V}$ , $I_C = 40\text{ A}$ , $T_J = 175\text{ °C}$		1.8		
$V_F$	Forward on-voltage	$I_F = 5\text{ A}$		2		V
		$I_F = 5\text{ A}$ , $T_J = 125\text{ °C}$		1.85		
		$I_F = 5\text{ A}$ , $T_J = 175\text{ °C}$		1.75		
$V_{GE(th)}$	Gate threshold voltage	$V_{CE} = V_{GE}$ , $I_C = 1\text{ mA}$	5	6	7	V
$I_{CES}$	Collector cut-off current	$V_{GE} = 0\text{ V}$ , $V_{CE} = 650\text{ V}$			25	$\mu\text{A}$
$I_{GES}$	Gate-emitter leakage current	$V_{CE} = 0\text{ V}$ , $V_{GE} = \pm 20\text{ V}$			$\pm 250$	nA

**Table 5: Dynamic characteristics**

Symbol	Parameter	Test conditions	Min.	Typ.	Max.	Unit
$C_{ies}$	Input capacitance	$V_{CE} = 25\text{ V}$ , $f = 1\text{ MHz}$ , $V_{GE} = 0\text{ V}$	-	5412	-	pF
$C_{oes}$	Output capacitance		-	198	-	
$C_{res}$	Reverse transfer capacitance		-	107	-	
$Q_g$	Total gate charge	$V_{CC} = 520\text{ V}$ , $I_C = 40\text{ A}$ , $V_{GE} = 15\text{ V}$ (see <a href="#">Figure 29: "Gate charge test circuit"</a> )	-	210	-	nC
$Q_{ge}$	Gate-emitter charge		-	39	-	
$Q_{gc}$	Gate-collector charge		-	82	-	

**Table 6: IGBT switching characteristics (inductive load)**

Symbol	Parameter	Test conditions	Min.	Typ.	Max.	Unit
$t_{d(off)}$	Turn-off-delay time	$V_{CE} = 400\text{ V}$ , $I_C = 40\text{ A}$ , $V_{GE} = 15\text{ V}$ , $R_G = 5\ \Omega$ (see <a href="#">Figure 28: "Test circuit for inductive load switching"</a> )	-	142	-	ns
$t_f$	Current fall time		-	27	-	ns
$E_{off}^{(1)}$	Turn-off switching energy		-	363	-	$\mu\text{J}$
$t_{d(off)}$	Turn-off-delay time	$V_{CE} = 400\text{ V}$ , $I_C = 40\text{ A}$ , $V_{GE} = 15\text{ V}$ , $R_G = 5\ \Omega$ , $T_J = 175\text{ °C}$ (see <a href="#">Figure 28: "Test circuit for inductive load switching"</a> )	-	141	-	ns
$t_f$	Current fall time		-	61	-	ns
$E_{off}$	Turn-off switching energy		-	764	-	$\mu\text{J}$

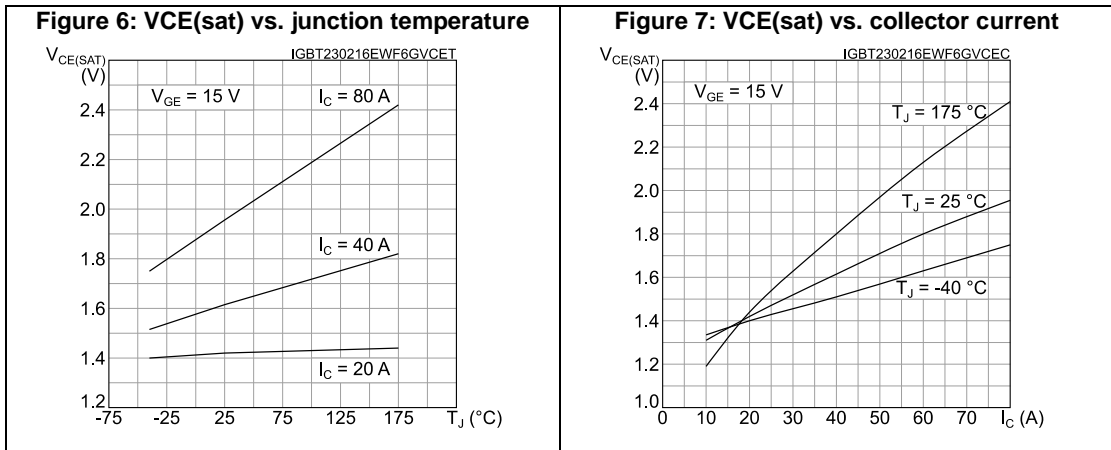
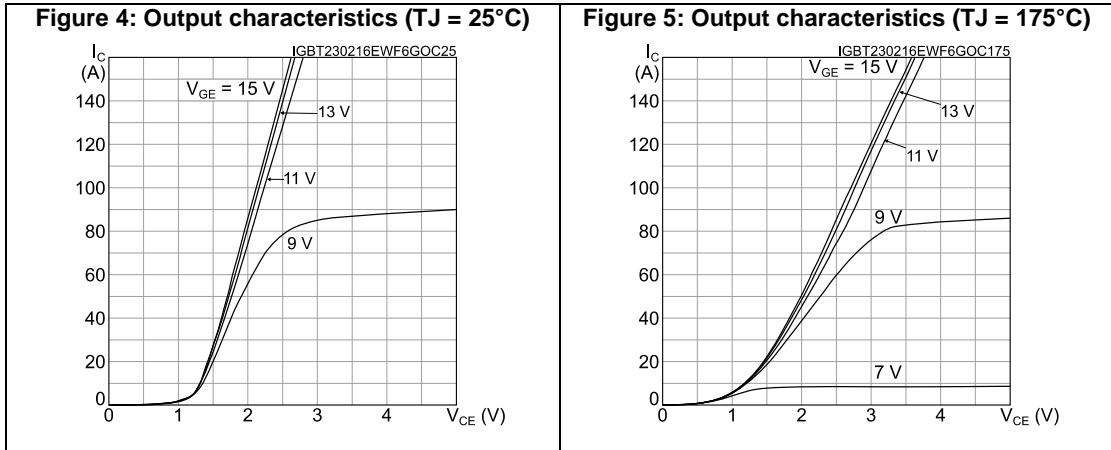
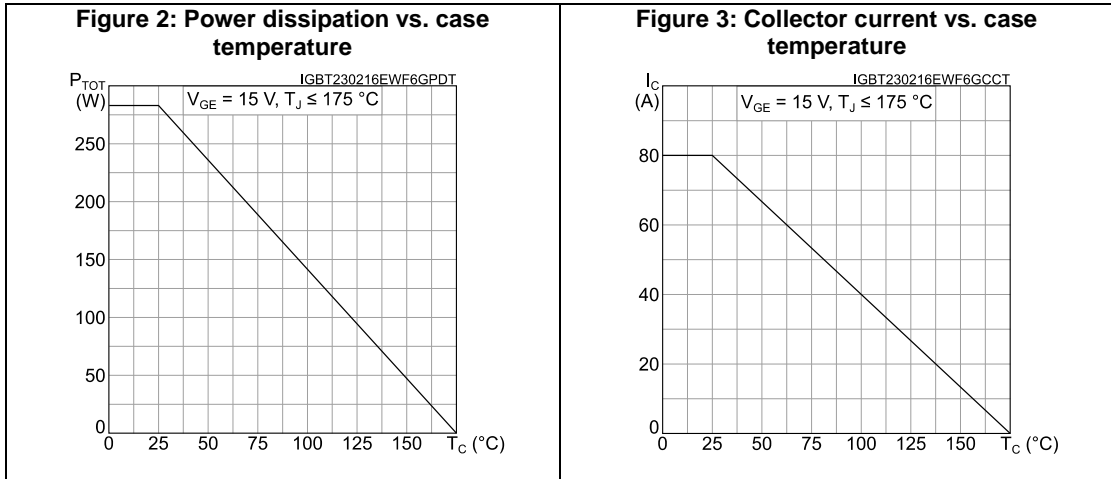
**Notes:**

<sup>(1)</sup>Including the tail of the collector current.

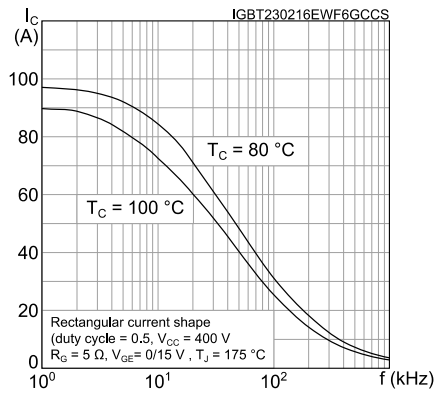
Table 7: Diode switching characteristics (inductive load)

Symbol	Parameter	Test conditions	Min.	Typ.	Max.	Unit
$t_{rr}$	Reverse recovery time	$I_F = 5\text{ A}$ , $V_R = 400\text{ V}$ , $V_{GE} = 15\text{ V}$ (see <a href="#">Figure 28: "Test circuit for inductive load switching"</a> ) $di/dt = 1000\text{ A}/\mu\text{s}$	-	140		ns
$Q_{rr}$	Reverse recovery charge		-	21		nC
$I_{rrm}$	Reverse recovery current		-	6.6		A
$di_{rr}/dt$	Peak rate of fall of reverse recovery current during $t_b$		-	430		A/ $\mu\text{s}$
$E_{rr}$	Reverse recovery energy		-	1.6		$\mu\text{J}$
$t_{rr}$	Reverse recovery time	$I_F = 5\text{ A}$ , $V_R = 400\text{ V}$ , $V_{GE} = 15\text{ V}$ $T_J = 175\text{ }^\circ\text{C}$ (see <a href="#">Figure 28: "Test circuit for inductive load switching"</a> ) $di/dt = 1000\text{ A}/\mu\text{s}$	-	200		ns
$Q_{rr}$	Reverse recovery charge		-	47.3		nC
$I_{rrm}$	Reverse recovery current		-	9.6		A
$di_{rr}/dt$	Peak rate of fall of reverse recovery current during $t_b$		-	428		A/ $\mu\text{s}$
$E_{rr}$	Reverse recovery energy		-	3.2		$\mu\text{J}$

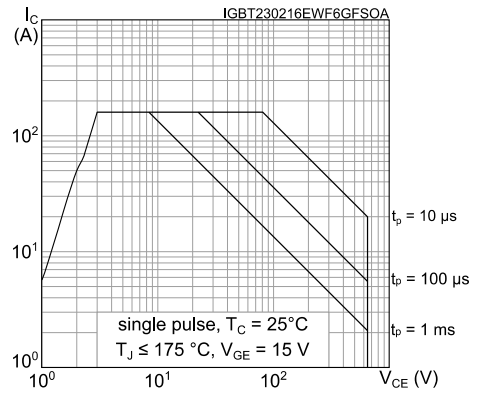
## 2.1 Electrical characteristics (curves)



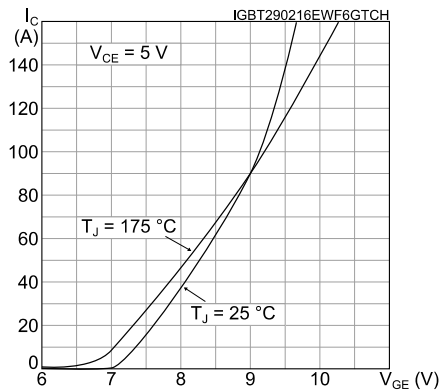
**Figure 8: Collector current vs. switching frequency**



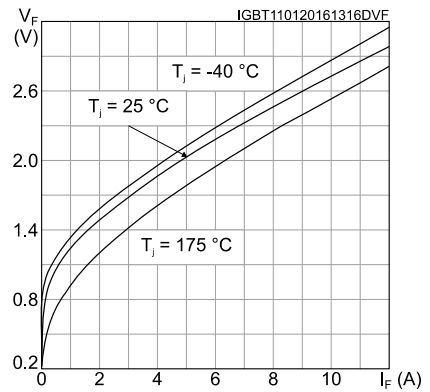
**Figure 9: Forward bias safe operating area**



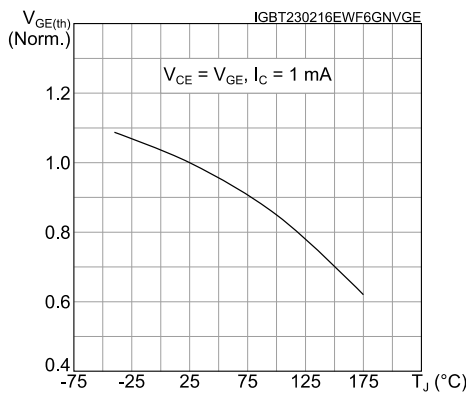
**Figure 10: Transfer characteristics**



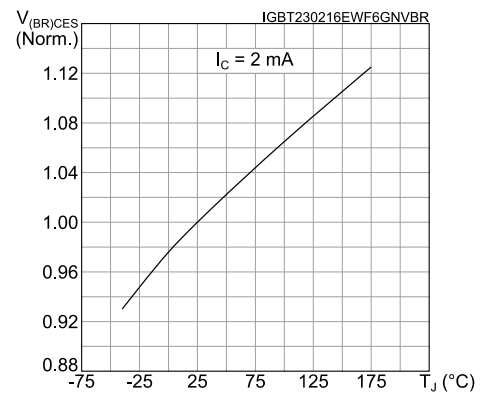
**Figure 11: Diode VF vs. forward current**

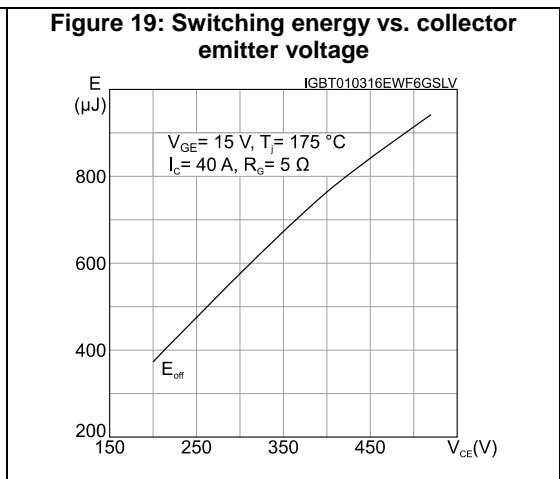
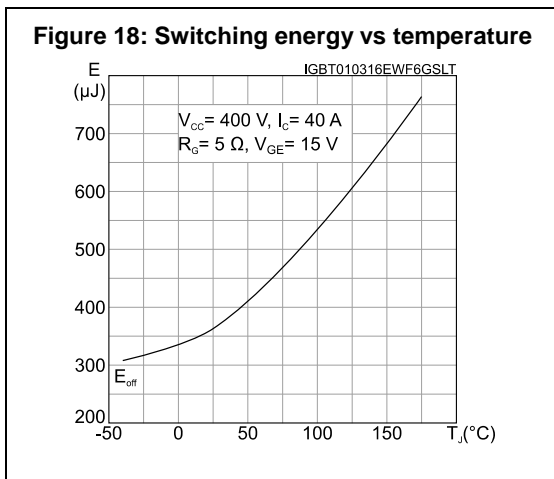
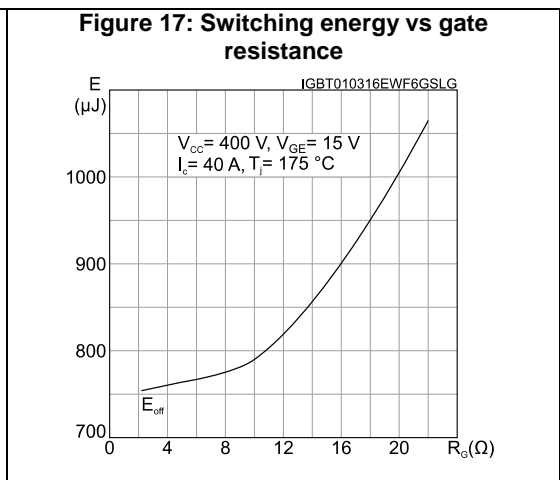
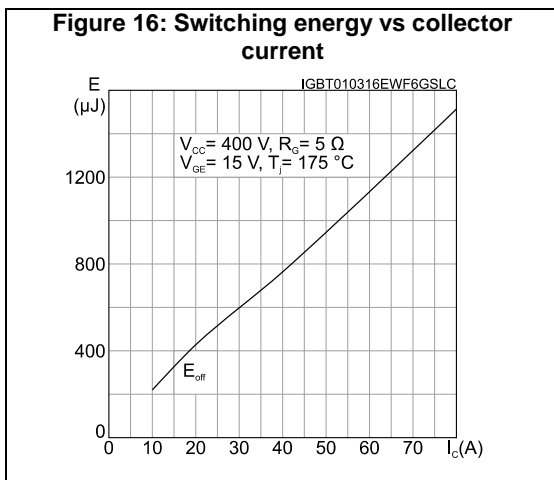
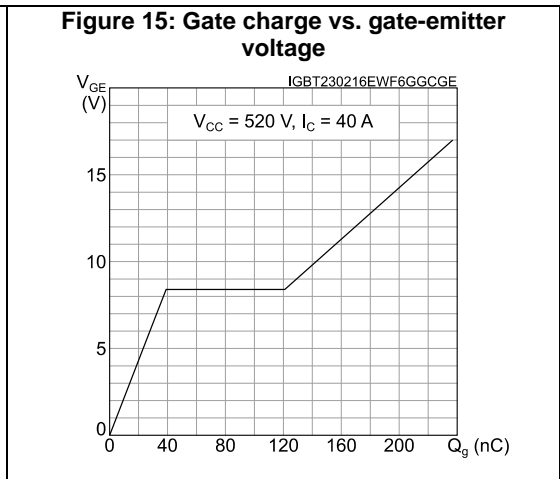
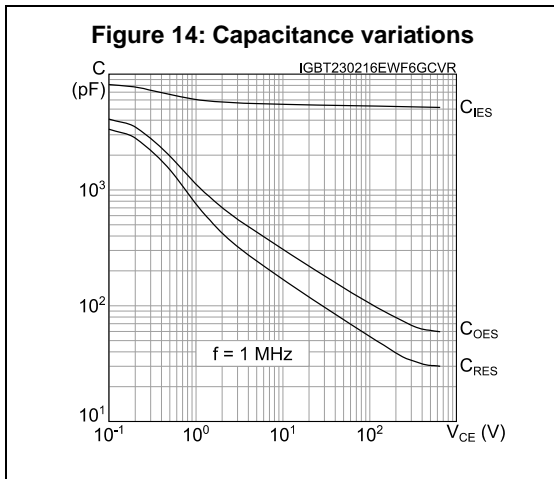


**Figure 12: Normalized VGE(th) vs junction temperature**



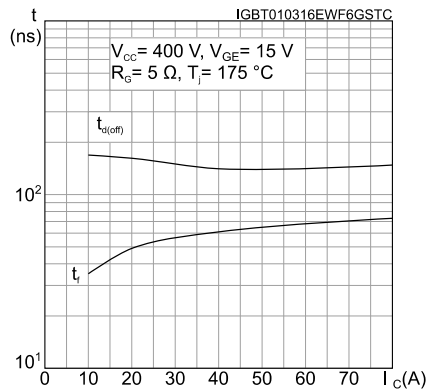
**Figure 13: Normalized V(BR)CES vs. junction temperature**



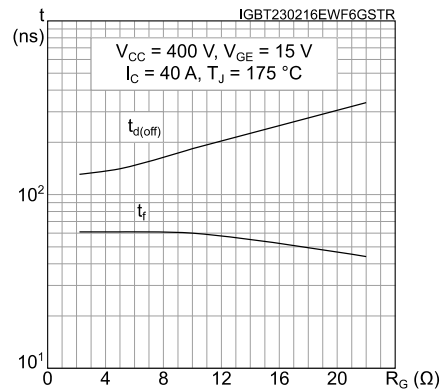




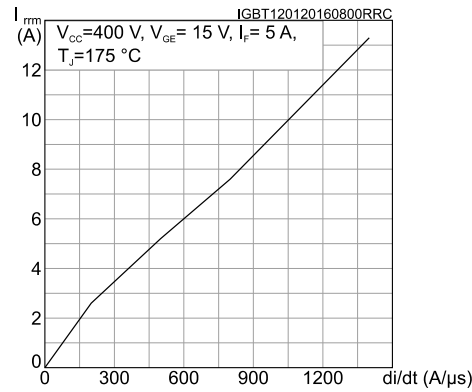
**Figure 20: Switching times vs. collector current**



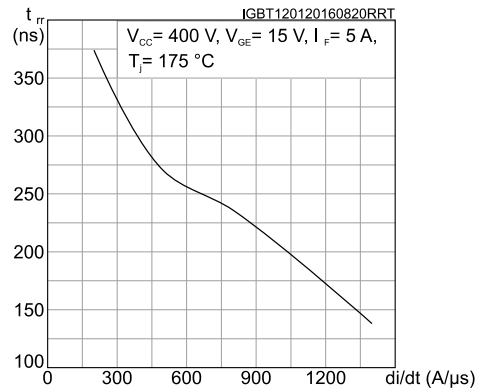
**Figure 21: Switching times vs. gate resistance**



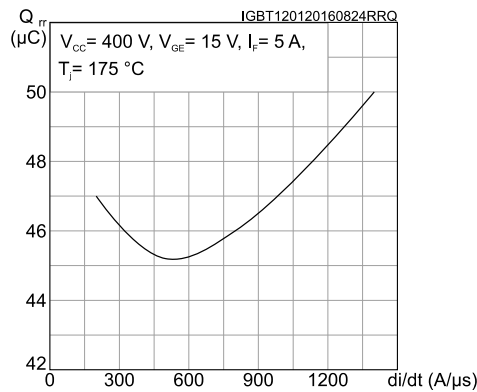
**Figure 22: Reverse recovery current vs. diode current slope**



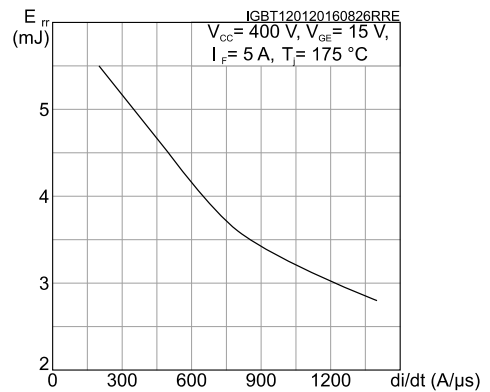
**Figure 23: Reverse recovery time vs. diode current slope**



**Figure 24: Reverse recovery charge vs. diode current slope**



**Figure 25: Reverse recovery energy vs. diode current slope**



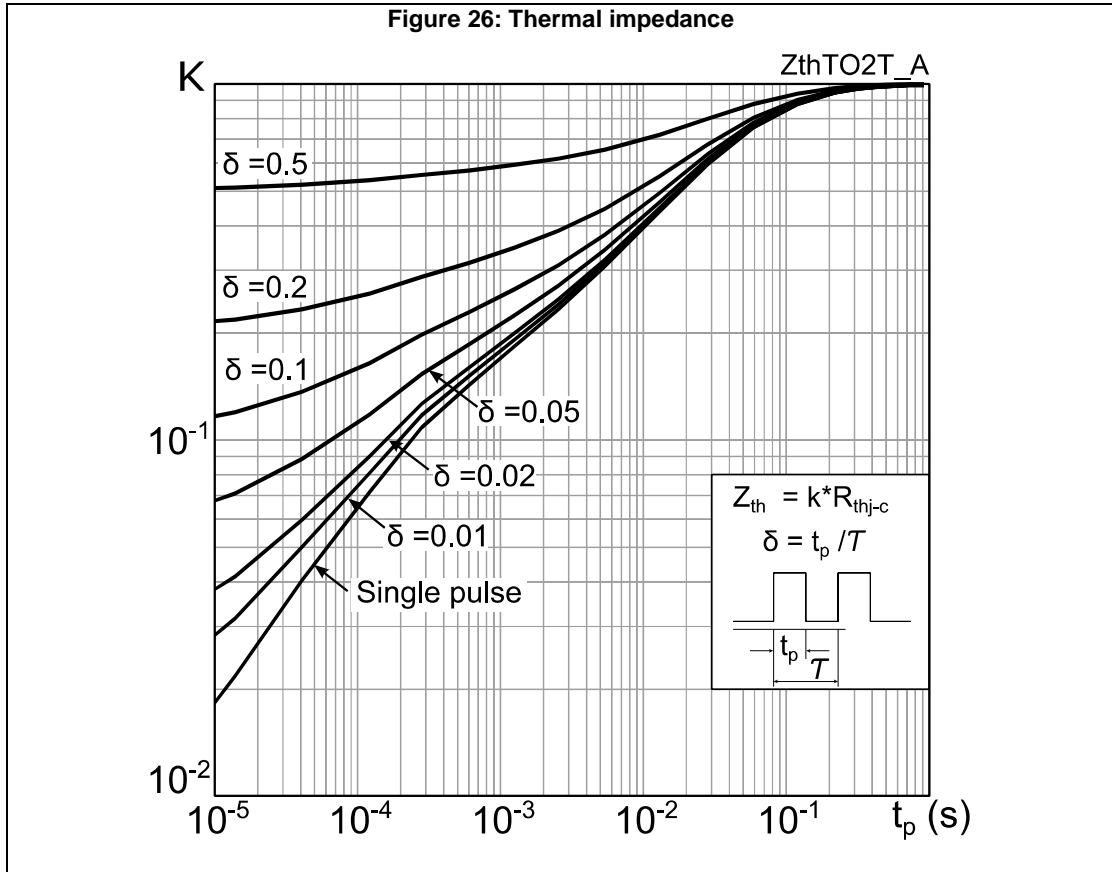
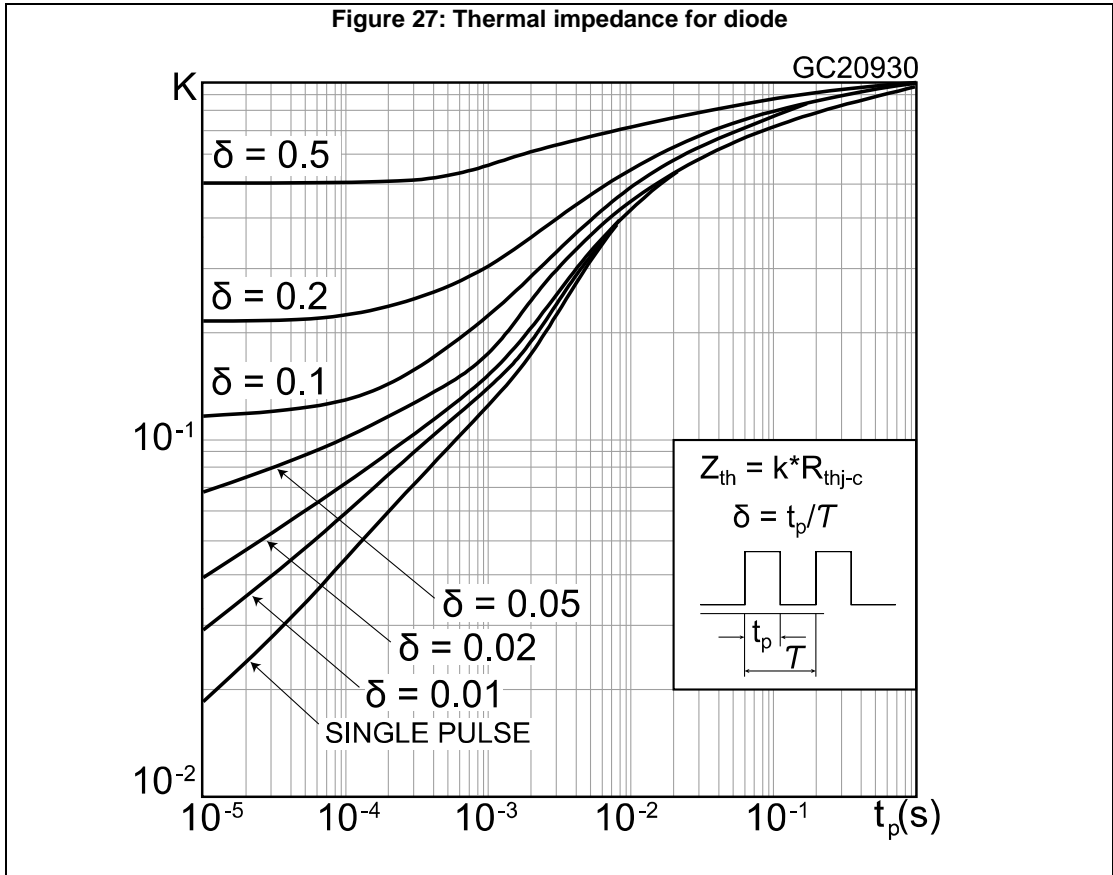
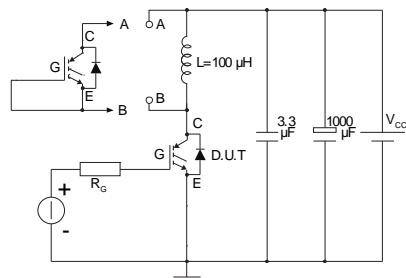


Figure 27: Thermal impedance for diode



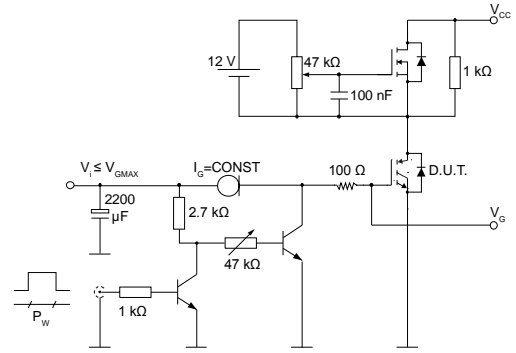
### 3 Test circuits

**Figure 28: Test circuit for inductive load switching**



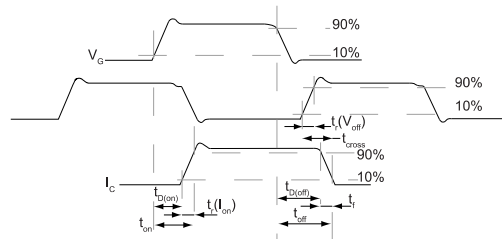
AM01504v1

**Figure 29: Gate charge test circuit**



AM01505v1

**Figure 30: Switching waveform**



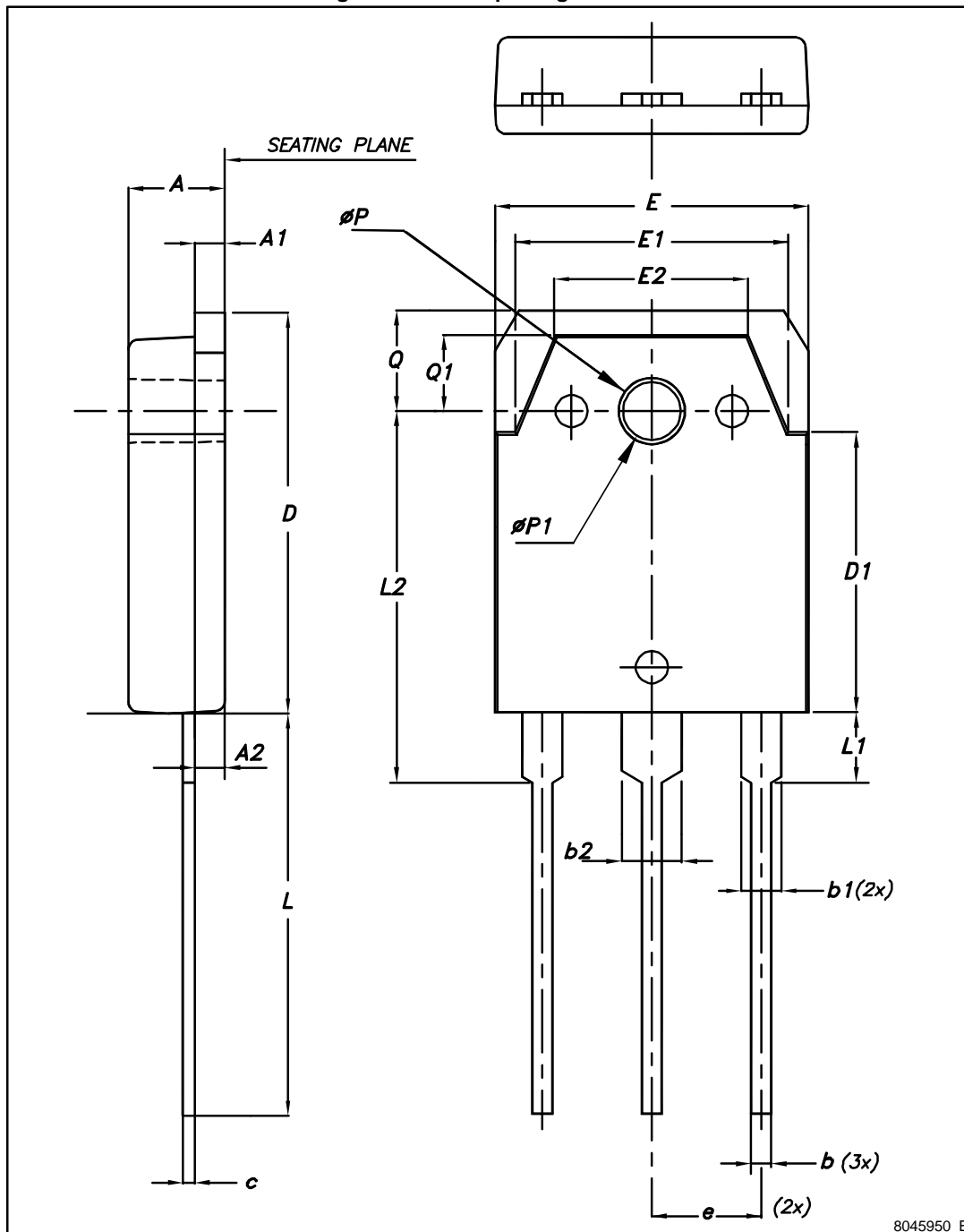
AM01506v1

## 4 Package information

In order to meet environmental requirements, ST offers these devices in different grades of ECOPACK® packages, depending on their level of environmental compliance. ECOPACK® specifications, grade definitions and product status are available at: [www.st.com](http://www.st.com). ECOPACK® is an ST trademark.

### 4.1 TO-3P package information

Figure 31: TO-3P package outline



8045950\_B

Table 8: TO-3P package mechanical data

Dim.	mm		
	Min.	Typ.	Max.
A	4.60	4.80	5.00
A1	1.45	1.50	1.65
A2	1.20	1.40	1.60
b	0.80	1.00	1.20
b1	1.80	2.00	2.20
b2	2.80	3.00	3.20
c	0.55	0.60	0.75
D	19.70	19.90	20.10
D1	13.70	13.90	14.10
E	15.40	15.60	15.80
E1	13.40	13.60	13.80
E2	9.40	9.60	9.90
e	5.15	5.45	5.75
L	19.80	20.00	20.20
L1	3.30	3.50	3.70
L2	18.20	18.40	18.60
ØP	3.30	3.40	3.50
ØP1	3.10	3.20	3.30
Q	4.80	5.00	5.20
Q1	3.60	3.80	4

## 5 Revision history

**Table 9: Document revision history**

Date	Revision	Changes
20-Oct-2015	1	First release.
01-Mar-2016	2	Updated features in cover page. Inserted <i>Section 2.1: "Electrical characteristics (curves)"</i> . Minor text changes
13-Jul-2016	3	Document status promoted from preliminary to production data.



**IMPORTANT NOTICE – PLEASE READ CAREFULLY**

STMicroelectronics NV and its subsidiaries ("ST") reserve the right to make changes, corrections, enhancements, modifications, and improvements to ST products and/or to this document at any time without notice. Purchasers should obtain the latest relevant information on ST products before placing orders. ST products are sold pursuant to ST's terms and conditions of sale in place at the time of order acknowledgement.

Purchasers are solely responsible for the choice, selection, and use of ST products and ST assumes no liability for application assistance or the design of Purchasers' products.

No license, express or implied, to any intellectual property right is granted by ST herein.

Resale of ST products with provisions different from the information set forth herein shall void any warranty granted by ST for such product.

ST and the ST logo are trademarks of ST. All other product or service names are the property of their respective owners.

Information in this document supersedes and replaces information previously supplied in any prior versions of this document.

© 2016 STMicroelectronics – All rights reserved