

ST SERIES - MINIATURE TOGGLE SWITCHES

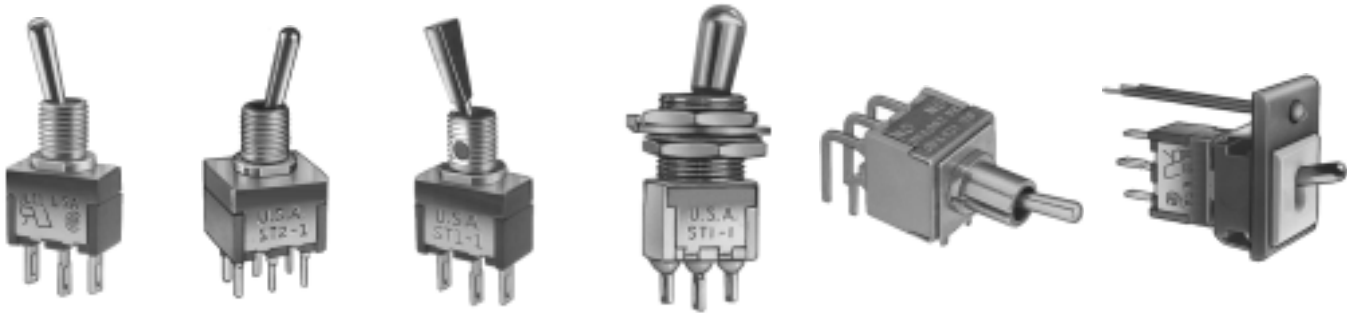

FEATURES

- Dry circuit through power ratings .
- Ultra-rugged construction SPDT & DPDT models with numerous options.
- Panel, panel & p.c. and p.c. mounting models, lighted and unlighted.

SPECIFICATIONS

Contact ratings (resistive loads): (Q) power models - coin silver: 6 Amps at 125 VAC, 3 Amps at 250 VAC or 7 Amps at 30 VDC.
(B) dry circuit models - gold over nickel over brass: 0.4 VA max. at 20 V max.
UL models - coin silver: 6 Amps at 125 VAC or 3 Amps at 250 VAC (75% power factor). UL file no. E66367. CSA models - coin silver: same ratings as UL models. CSA file no. LR54592-1.

Initial contact resistance: 3 milliohms max. at 3 VDC, 0.1 Amp.

Insulation resistance: Greater than 200,000 megohms between terminals & case ground.

Dielectric strength: Greater than 2000 VAC for 1 minute between terminals & case ground.

Electrical life (resistive loads): 100,000 cycles min. for ST1-1 & ST2-1. Other models, 40,000 cycles min.

Operating temperature range: -30°C to +85°C

MATERIALS

Contacts: Coin silver for power, UL & CSA models. Gold over nickel over brass for dry circuit models.

Actuator: Brass, bright nickel or chrome plated.

Bushing: Nickel plated brass

Strap: Stainless steel

Case: DAP, color blue

Terminal seal: Epoxy (optional)

Support bracket: Brass or steel, tin plated

Spring mounting bracket: Stainless steel

Bezel & bezel insert: Nylon. Available in black, red & white. Consult factory for other colors.

Hardware: See 'Miscellaneous' section.

LED: Intensity: 2.0 mcd at 10 mA. Forward voltage: 2.0V (3.0V max.). Max. continuous forward current: 15 mA for red, 30 mA for green & 20 mA for yellow. Red is standard. Yellow & green are optional. Specifications are subject to change without notice - consult factory.

AGENCY RECOGNITION



UL, & CSA. Marking: Switches ordered by UL model number are supplied with recognition marking. Switches ordered by UL model no. and with '/CSA' added at end of model no. are supplied with both recognitions marked.

ABOUT THIS SERIES

The material in this series is organized in the following sequence:

- Completely specified switch models
- Miscellaneous
- 'build your own switch' order format
- Option drawings & information
- Panel cut-outs

ST SERIES - MINIATURE TOGGLE SWITCHES

Solder lug terminals - panel mounting

SINGLE POLE



DOUBLE POLE



	POWER CKT. MODEL NO.	UL MODEL NO.	USA marking on opposite side		
Sing'l pole	ST1-1KMZQ	UL11KMZQ	ON	NONE	ON
	ST1-2KMZQ	UL12KMZQ	ON	OFF	ON
	ST1-4KMZQ	UL14KMZQ	ON	OFF	MOM
Double pole	ST2-1KMZQ	UL21KMZQ	ON	NONE	ON
	ST2-3KMZQ	UL23KMZQ	ON	OFF	ON
	ST2-4KMZQ	UL24KMZQ	ON	OFF	MOM
	ST2-6KMZQ	UL26KMZQ	ON	ON	ON
	ST2-7KMZQ	UL27KMZQ	ON	ON	MOM
ST2-8KMZQ	UL28KMZQ	MOM	ON	MOM	
Terminals connected (-6, -7 & -8)			1-2,	1-2,	2-3,
			4-5	5-6	5-6

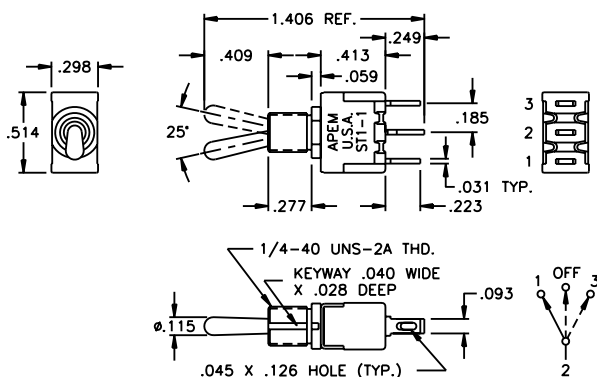

Terminal numbers for reference only

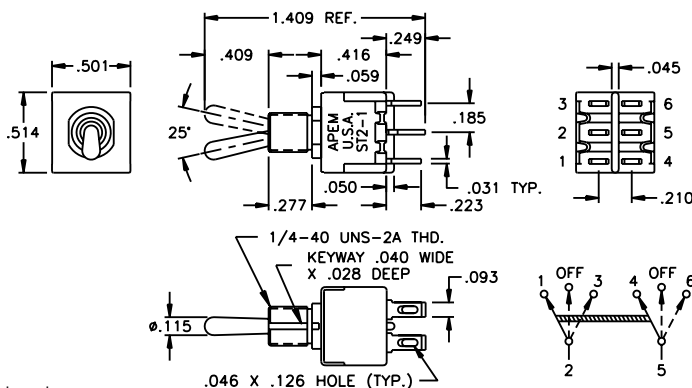

SINGLE POLE

DOUBLE POLE

Straight p.c. terminals - panel mounting

SINGLE POLE



DOUBLE POLE



	POWER CKT. MODEL NO.	UL MODEL NO.	USA marking on opposite side		
Sing'l pole	ST1-1KMCB	UL11KMCQ	ON	NONE	ON
	ST1-2KMCB	UL12KMCQ	ON	OFF	ON
	ST1-4KMCB	UL14KMCQ	ON	OFF	MOM
Double pole	ST2-1KMCB	UL21KMCQ	ON	NONE	ON
	ST2-2KMCB	UL22KMCQ	ON	OFF	ON
	ST2-4KMCB	UL24KMCQ	ON	OFF	MOM
	ST2-6KMCB	UL26KMCQ	ON	ON	ON
	ST2-7KMCB	UL27KMCQ	ON	ON	MOM
ST2-8KMCB	UL28KMCQ	MOM	ON	MOM	
Terminals connected (-6, -7 & -8)			1-2,	1-2,	2-3,
			4-5	5-6	5-6

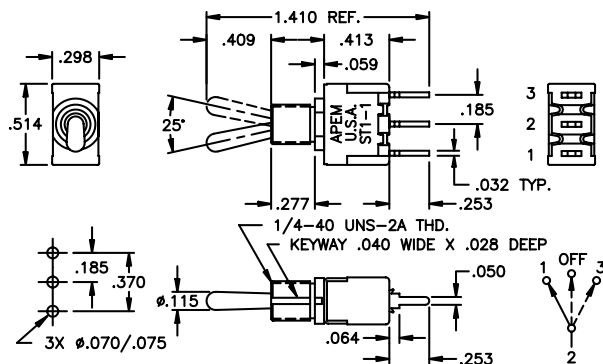

Terminal numbers for reference only

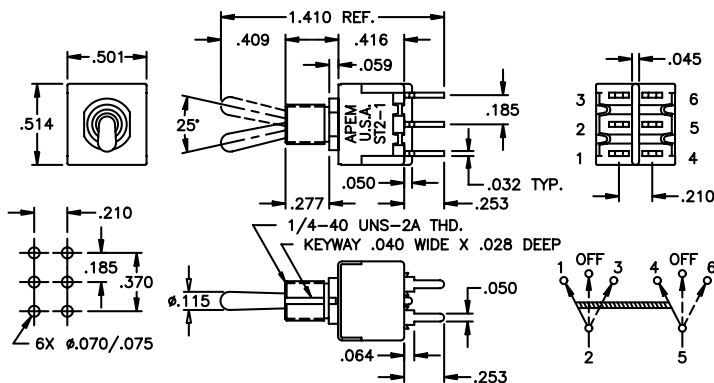

SINGLE POLE

DOUBLE POLE

SPECIFICATIONS SUBJECT TO CHANGE WITHOUT NOTICE

ST SERIES - MINIATURE TOGGLE SWITCHES

Flatted actuator - panel mounting

SINGLE POLE



DOUBLE POLE



	POWER CKT. MODEL NO.	UL MODEL NO.	USA marking on opposite side		
Sing'l pole	ST1-1F1MZQ	UL11F1MZQ	ON	NONE	ON
	ST1-2F1MZQ	UL12F1MZQ	ON	OFF	ON
	ST1-4F1MZQ	UL14F1MZQ	ON	OFF	MOM
Double pole	ST2-1F1MZQ	UL21F1MZQ	ON	NONE	ON
	ST2-2F1MZQ	UL22F1MZQ	ON	OFF	ON
	ST2-4F1MZQ	UL24F1MZQ	ON	OFF	MOM
	ST2-6F1MZQ	UL26F1MZQ	ON	ON	ON
	ST2-7F1MZQ	UL27F1MZQ	ON	ON	MOM
	ST2-8F1MZQ	UL28F1MZQ	MOM	ON	MOM
	Terminals connected (-6, -7 & -8)		1-2, 4-5	1-2, 5-6	2-3, 5-6

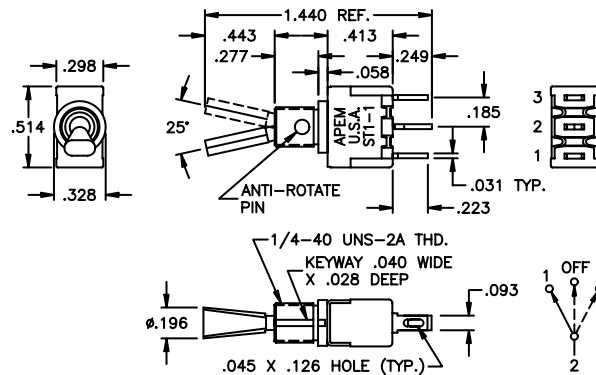

Terminal numbers for reference only

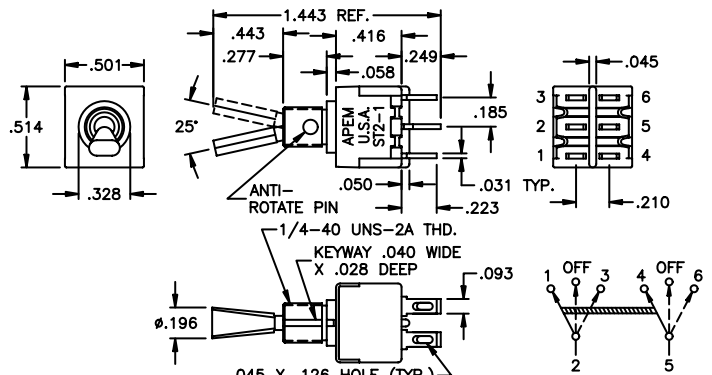

DOUBLE POLE

Splashproof bushing - panel mounting

An 'o'-ring placed internally between the actuator and the bushing, and a gasket placed externally between the bushing flange and mounting panel provides static protection from 3.3 ft. (1 meter) of water for 30 minutes.

SINGLE POLE



DOUBLE POLE



	POWER CKT. MODEL NO.	UL MODEL NO.	USA marking on opposite side		
Sing'l pole	ST1-1KHZQ	UL11KHZQ	ON	NONE	ON
	ST1-2KHZQ	UL12KHZQ	ON	OFF	ON
	ST1-4KHZQ	UL14KHZQ	ON	OFF	MOM
Double pole	ST2-1KHZQ	UL21KHZQ	ON	NONE	ON
	ST2-2KHZQ	UL22KHZQ	ON	OFF	ON
	ST2-4KHZQ	UL24KHZQ	ON	OFF	MOM
	ST2-6KHZQ	UL26KHZQ	ON	ON	ON
	ST2-7KHZQ	UL27KHZQ	ON	ON	MOM
	ST2-8KHZQ	UL28KHZQ	MOM	ON	MOM
	Terminals connected (-6, -7 & -8)		1-2, 4-5	1-2, 5-6	2-3, 5-6

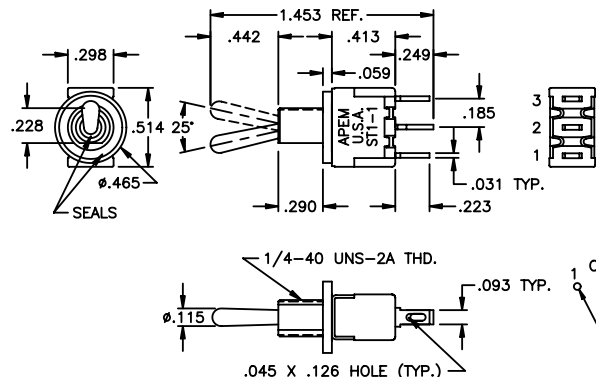

Terminal numbers for reference only

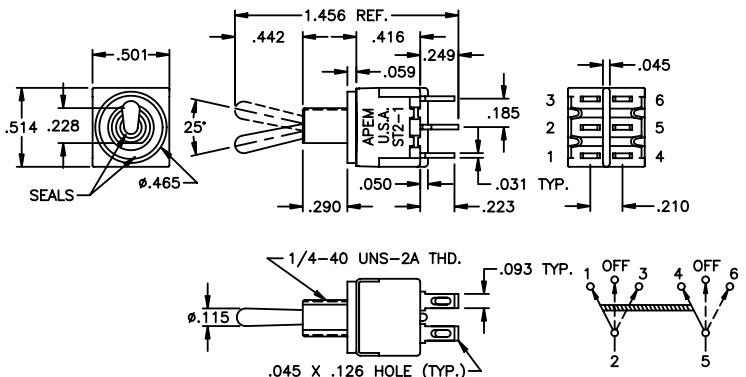

DOUBLE POLE

SPECIFICATIONS SUBJECT TO CHANGE WITHOUT NOTICE

ST SERIES - MINIATURE TOGGLE SWITCHES

Horizontal right angle p.c. terminals - p.c. mounting

SINGLE POLE



DOUBLE POLE



	POWER CKT. MODEL NO.	UL MODEL NO.	USA marking on opposite side		
Sing'l pole	ST1-1L3S3AB	UL11L3S3AQ	ON	NONE	ON
	ST1-2L3S3AB	UL12L3S3AQ	ON	OFF	ON
	ST1-4L3S3AB	UL14L3S3AQ	ON	OFF	MOM
Double pole	ST2-1L3S3AB	UL21L3S3AQ	ON	NONE	ON
	ST2-2L3S3AB	UL22L3S3AQ	ON	OFF	ON
	ST2-4L3S3AB	UL24L3S3AQ	ON	OFF	MOM
	ST2-6L3S3AB	UL26L3S3AQ	ON	ON	ON
	ST2-7L3S3AB	UL27L3S3AQ	ON	ON	MOM
	ST2-8L3S3AB	UL28L3S3AQ	MOM	ON	MOM
Terminals connected (-6, -7 & -8)			1-2,	1-2,	2-3,
			4-5	5-6	5-6

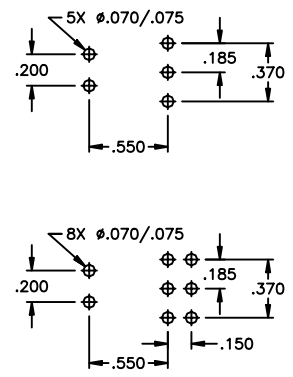
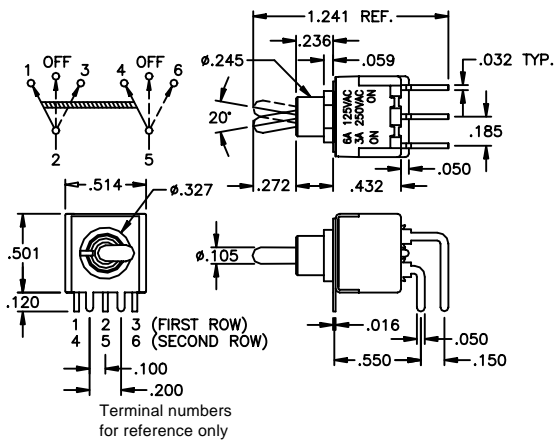
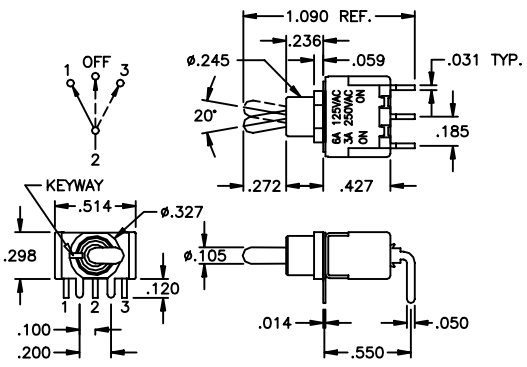

SINGLE POLE

DOUBLE POLE

Terminal numbers for reference only

Vertical right angle p.c. terminals - p.c. mounting

SINGLE POLE



DOUBLE POLE



	POWER CKT. MODEL NO.	UL MODEL NO.	USA marking on opposite side		
Sing'l pole	ST1-1L3S3V-1B	UL11L3S3V-1Q	ON	NONE	ON
	ST1-2L3S3V-1B	UL12L3S3V-1Q	ON	OFF	ON
	ST1-4L3S3V-1B	UL14L3S3V-1Q	ON	OFF	MOM
Double pole	ST2-1L3S3V-1B	UL21L3S3V-1Q	ON	NONE	ON
	ST2-2L3S3V-1B	UL22L3S3V-1Q	ON	OFF	ON
	ST2-4L3S3V-1B	UL24L3S3V-1Q	ON	OFF	MOM
	ST2-6L3S3V-1B	UL26L3S3V-1Q	ON	ON	ON
	ST2-7L3S3V-1B	UL27L3S3V-1Q	ON	ON	MOM
	ST2-8L3S3V-1B	UL28L3S3V-1Q	MOM	ON	MOM
Terminals connected (-6, -7 & -8)			1-2,	1-2,	2-3,
			4-5	5-6	5-6

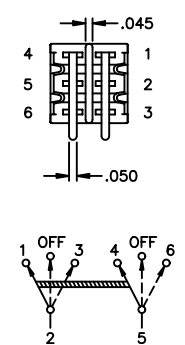
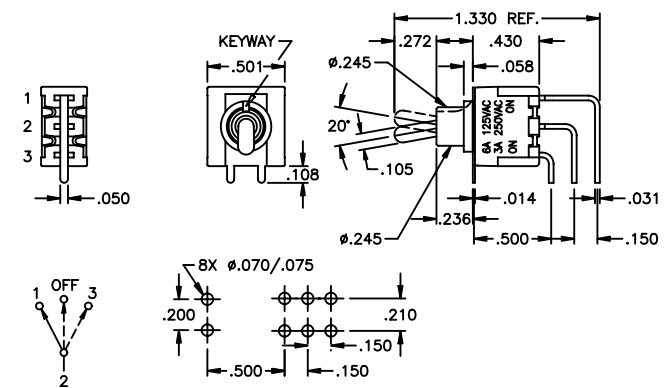
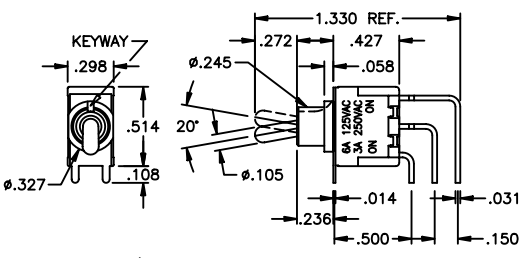

SINGLE POLE

DOUBLE POLE

Terminal numbers for reference only

SPECIFICATIONS SUBJECT TO CHANGE WITHOUT NOTICE

ST SERIES - MINIATURE TOGGLE SWITCHES

Snap-in bezel with outboard LED

PATENT NO.
Des. 282,524

UL11KMZQJ6128



	POWER CKT. MODEL NO.	UL MODEL NO.	USA marking on opposite side		
	Sing'l pole	ST1-1KMZQJ6122 ST1-2KMZQJ6122 ST1-4KMZQJ6122	UL11KMZQJ6122 UL12KMZQJ6122 UL14KMZQJ6122	ON	NONE
Double pole	ST2-1KMZQJ6122	UL21KMZQJ6122	ON	NONE	ON
	ST2-2KMZQJ6122	UL22KMZQJ6122	ON	OFF	ON
	ST2-4KMZQJ6122	UL24KMZQJ6122	ON	OFF	MOM
	ST2-6KMZQJ6122	UL26KMZQJ6122	ON	ON	ON
	ST2-7KMZQJ6122	UL27KMZQJ6122	ON	ON	MOM
	ST2-8KMZQJ6122	UL28KMZQJ6122	MOM	ON	MOM
Terminals connected (-6, -7 & -8)			1-2, 4-5	1-2, 5-6	2-3, 5-6

Above models have black bezel and insert.

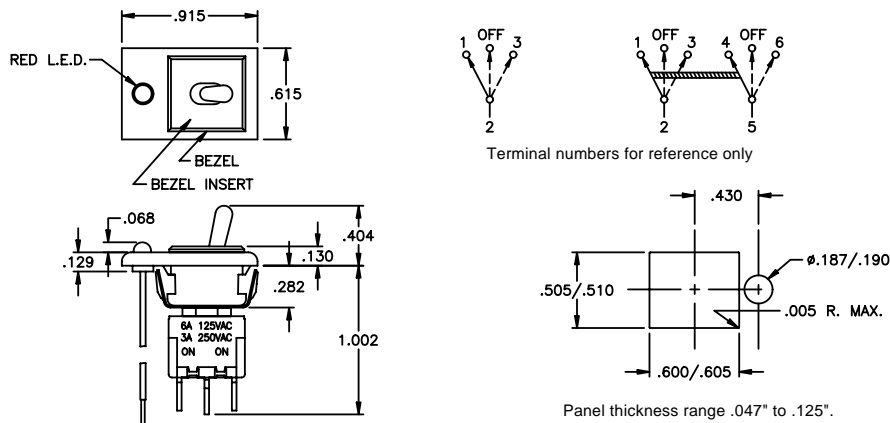

Snap-in bezel with 0, 1 or 2 inboard LEDs

PATENT NO.
Des. 282,524

ST1-1KMZQJ9128



	POWER CKT. MODEL NO.	UL MODEL NO.	USA marking on opposite side		
	Sing'l pole	ST1-1KMZQJ9122 ST1-2KMZQJ9122 ST1-4KMZQJ9122	UL11KMZQJ9122 UL12KMZQJ9122 UL14KMZQJ9122	ON	NONE
Double pole	ST2-1KMZQJ9122	UL21KMZQJ9122	ON	NONE	ON
	ST2-2KMZQJ9122	UL22KMZQJ9122	ON	OFF	ON
	ST2-4KMZQJ9122	UL24KMZQJ9122	ON	OFF	MOM
	ST2-6KMZQJ9122	UL26KMZQJ9122	ON	ON	ON
	ST2-7KMZQJ9122	UL27KMZQJ9122	ON	ON	MOM
	ST2-8KMZQJ9122	UL28KMZQJ9122	MOM	ON	MOM
Terminals connected (-6, -7 & -8)			1-2, 4-5	1-2, 5-6	2-3, 5-6

Above models have black bezel and insert.

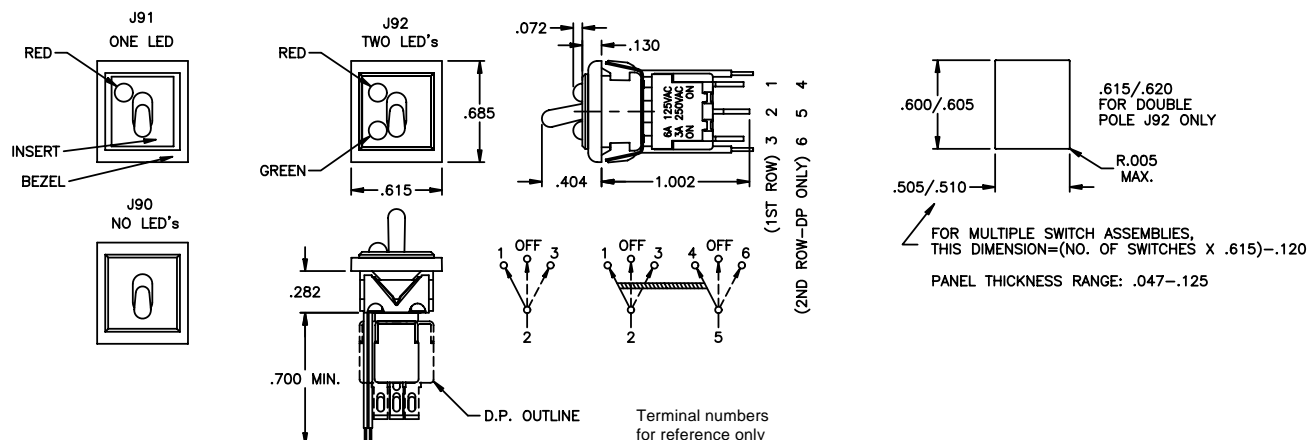

SPECIFICATIONS SUBJECT TO CHANGE WITHOUT NOTICE

ST SERIES - MINIATURE TOGGLE SWITCHES

Bezel for p.c. mounted switches with 0, 1 or 2 LEDs

PATENT NO.
Des. 282,524

ST1-1KMCBJ9488

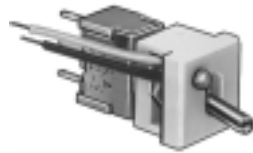

	POWER CKT. MODEL NO.	UL MODEL NO.	USA marking on opposite side		
Sing'l pole	ST1-1KMCBJ9422	UL11KMCQJ9422	ON	NONE	ON
	ST1-2KMCBJ9422	UL12KMCQJ9422	ON	OFF	ON
	ST1-4KMCBJ9422	UL14KMCQJ9422	ON	OFF	MOM
Double pole	ST2-1KMCBJ9422	UL21KMCQJ9422	ON	NONE	ON
	ST2-2KMCBJ9422	UL22KMCQJ9422	ON	OFF	ON
	ST2-4KMCBJ9422	UL24KMCQJ9422	ON	OFF	MOM
	ST2-6KMCBJ9422	UL26KMCQJ9422	ON	ON	ON
	ST2-7KMCBJ9422	UL27KMCQJ9422	ON	ON	MOM
	ST2-8KMCBJ9422	UL28KMCQJ9422	MOM	ON	MOM
Terminals connected (-6, -7 & -8)			1-2, 4-5	1-2, 5-6	2-3, 5-6

Above models have black bezel and insert.

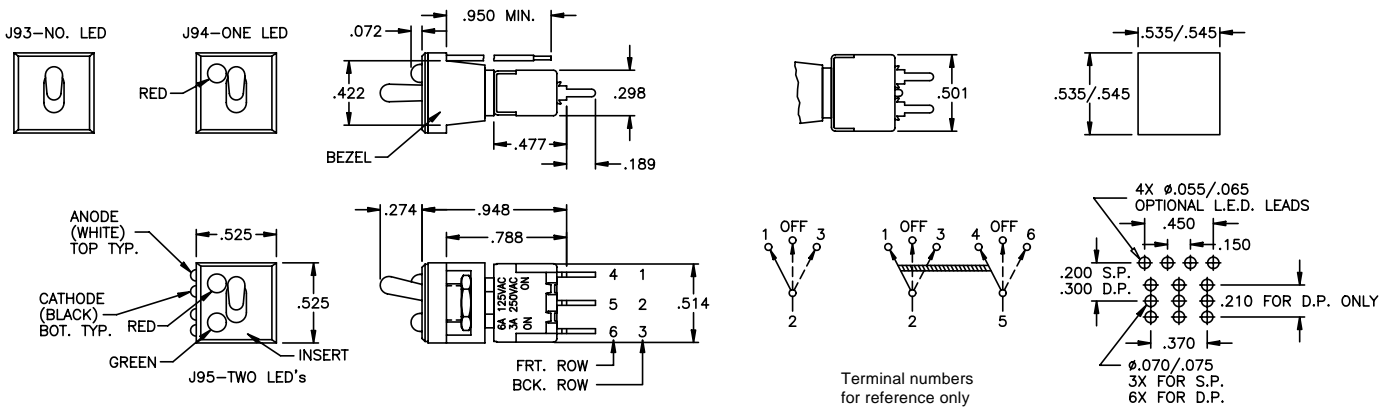

SPECIFICATIONS SUBJECT TO CHANGE WITHOUT NOTICE

Bezel for p.c. mounted switches with 0, 1 or 2 LEDs

PATENT NO.
Des. 282,524

ST1-1KMV30QJ9488



	POWER CKT. MODEL NO.	UL MODEL NO.	USA marking on opposite side		
Sing'l pole	ST1-1KMV30BJ9422	UL11KMV30QJ9422	ON	NONE	ON
	ST1-2KMV30BJ9422	UL12KMV30QJ9422	ON	OFF	ON
	ST1-4KMV30BJ9422	UL14KMV30QJ9422	ON	OFF	MOM
Double pole	ST2-1KMV30BJ9422	UL21KMV30QJ9422	ON	NONE	ON
	ST2-2KMV30BJ9422	UL22KMV30QJ9422	ON	OFF	ON
	ST2-4KMV30BJ9422	UL24KMV30QJ9422	ON	OFF	MOM
	ST2-6KMV30BJ9422	UL26KMV30QJ9422	ON	ON	ON
	ST2-7KMV30BJ9422	UL27KMV30QJ9422	ON	ON	MOM
	ST2-8KMV30BJ9422	UL28KMV30QJ9422	MOM	ON	MOM
Terminals connected (-6, -7 & -8)			1-2, 4-5	1-2, 5-6	2-3, 5-6

Above models have black bezel and insert.

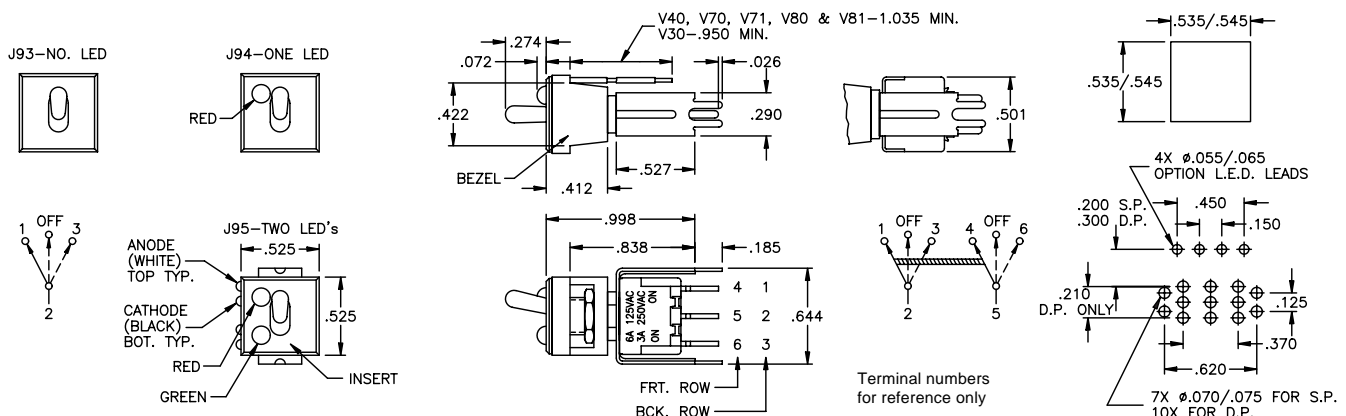

ST SERIES - MINIATURE TOGGLE SWITCHES

Bezel for right angle p.c. mtd. switches with 0, 1 or 2 LEDs

PATENT NO.
Des. 282,524

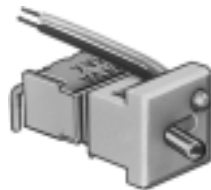

ST1-1KMA-1BJ9488

Poles	Option	Dim. A	Dim. B
SP	A	.148	.045 max.
SP	A-1	.164	.095 max.
DP	A	.250	.300 max.
DP	A-1	.266	.350 max.

	POWER CKT. MODEL NO.		UL MODEL NO.			USA marking on opposite side				
						ON	NONE	ON		
Sing'l pole	ST1-1KMA-1BJ9422		UL11KMA-1QJ9422			ON	NONE	ON		
	ST1-2KMA-1BJ9422		UL12KMA-1QJ9422			ON	OFF	ON		
	ST1-4KMA-1BJ9422		UL14KMA-1QJ9422			ON	OFF	MOM		
Double pole	ST2-1KMA-1BJ9422		UL21KMA-1QJ9422			ON	NONE	ON		
	ST2-2KMA-1BJ9422		UL22KMA-1QJ9422			ON	OFF	ON		
	ST2-4KMA-1BJ9422		UL24KMA-1QJ9422			ON	OFF	MOM		
	ST2-6KMA-1BJ9422		UL26KMA-1QJ9422			ON	ON	ON		
	ST2-7KMA-1BJ9422		UL27KMA-1QJ9422			ON	ON	MOM		
ST2-8KMA-1BJ9422		UL28KMA-1QJ9422			MOM	ON	MOM			
Terminals connected (-6, -7 & -8)					1-2,	1-2,	2-3,	4-5	5-6	5-6

Above models have black bezel and insert.

J93-NO. LED



J94-ONE LED

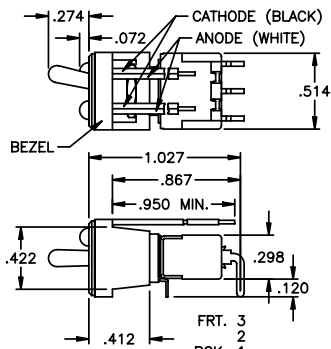
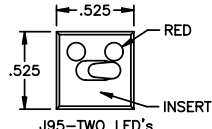
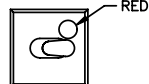

Terminal numbers for reference only

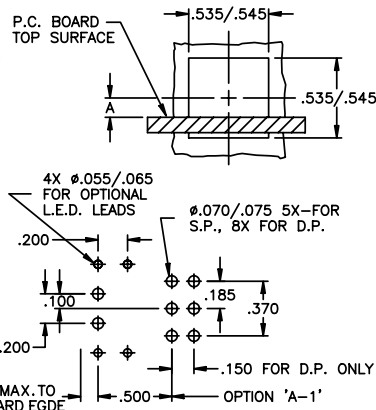

SPECIFICATIONS SUBJECT TO CHANGE WITHOUT NOTICE

Bezel for right angle p.c. mtd. switches with 0, 1 or 2 LEDs

PATENT NO.
Des. 282,524

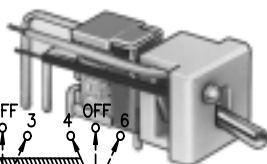

ST1-1KMV-1BJ9488

	POWER CKT. MODEL NO.		UL MODEL NO.			USA marking on opposite side				
						ON	NONE	ON		
Sing'l pole	ST1-1KMV-1BJ9422		UL11KMV-1QJ9422			ON	NONE	ON		
	ST1-2KMV-1BJ9422		UL12KMV-1QJ9422			ON	OFF	ON		
	ST1-4KMV-1BJ9422		UL14KMV-1QJ9422			ON	OFF	MOM		
Double pole	ST2-1KMV-1BJ9422		UL21KMV-1QJ9422			ON	NONE	ON		
	ST2-2KMV-1BJ9422		UL22KMV-1QJ9422			ON	OFF	ON		
	ST2-4KMV-1BJ9422		UL24KMV-1QJ9422			ON	OFF	MOM		
	ST2-6KMV-1BJ9422		UL26KMV-1QJ9422			ON	ON	ON		
	ST2-7KMV-1BJ9422		UL27KMV-1QJ9422			ON	ON	MOM		
ST2-8KMV-1BJ9422		UL28KMV-1QJ9422			MOM	ON	MOM			
Terminals connected (-6, -7 & -8)					1-2,	1-2,	2-3,	4-5	5-6	5-6

Above models have black bezel and insert.

J93-NO. LED

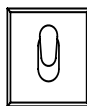

J94-ONE LED

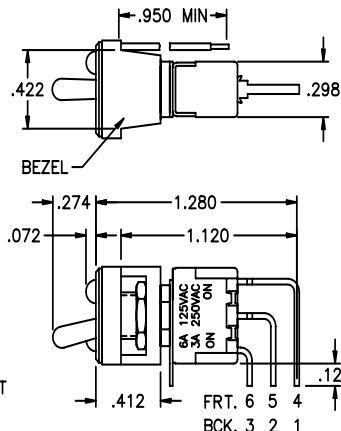
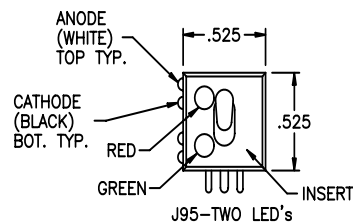
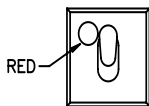

Terminal numbers for reference only

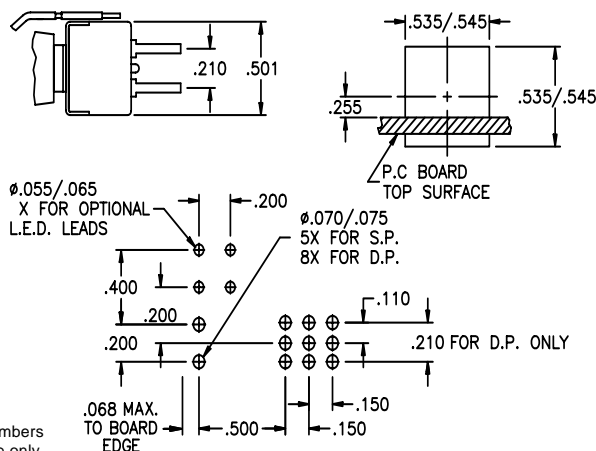

ST SERIES - MINIATURE TOGGLE SWITCHES

K

Snap-in bezel for round hole mounting with 0, 1 or 2 LEDs

Self keying against rotation

PATENT NO.
Des. 282,524

ST1-1KMZQJ9788



POWER CKT.
MODEL NO.

UL MODEL NO.

USA marking on opposite side

	POWER CKT. MODEL NO.	UL MODEL NO.	USA marking on opposite side		
Sing'l pole	ST1-1KMZQJ9722	UL11KMZQJ9722	ON	NONE	ON
	ST1-2KMZQJ9722	UL12KMZQJ9722	ON	OFF	ON
	ST1-4KMZQJ9722	UL14KMZQJ9722	ON	OFF	MOM
Double pole	ST2-1KMZQJ9722	UL21KMZQJ9722	ON	NONE	ON
	ST2-2KMZQJ9722	UL22KMZQJ9722	ON	OFF	ON
	ST2-4KMZQJ9722	UL24KMZQJ9722	ON	OFF	MOM
	ST2-6KMZQJ9722	UL26KMZQJ9722	ON	ON	ON
	ST2-7KMZQJ9722	UL27KMZQJ9722	ON	ON	MOM
	ST2-8KMZQJ9722	UL28KMZQJ9722	MOM	ON	MOM
Terminals connected (-6, -7 & -8)			1-2,	1-2,	2-3,
			4-5	5-6	5-6

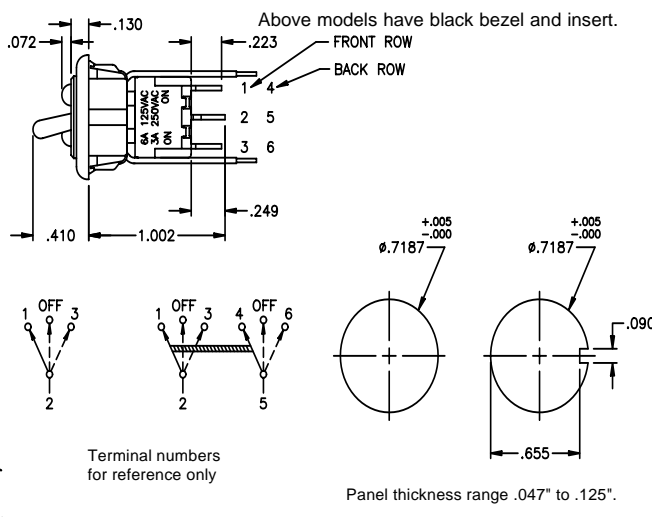
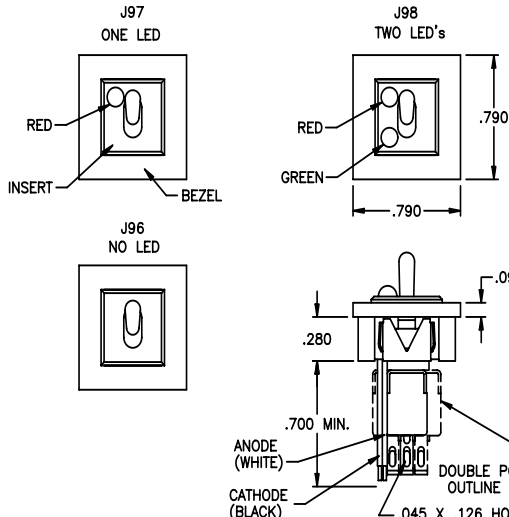

MISCELLANEOUS

ST2-6, -7 & -8 SWITCHES

May be wired as a single pole 3 position switch; add external jumper between terminals 1 & 5, then -

Common terminal is 2
Output 1 - terminal 4
Output 2 - terminal 6
Output 3 - terminal 3

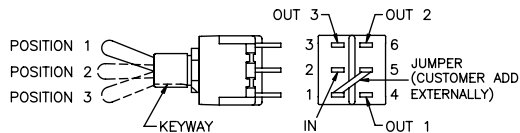

HARDWARE SUPPLIED

(See Hardware section of catalog)
Switches with M and Y option bushings are supplied with (2) A112 Hex Nuts, (1) A115 Lockwasher and (1) A107 Anti-rotate Ring.
Switches with D bushings are supplied with (2) A112 Hex Nuts and (1) A115 Lockwasher.
Switches with H option bushing are supplied with (1) A112 Hex Nut, (1) A115 Lockwasher and (1) A257 Gasket.
Switches with M4 and M5 bushings are supplied with (2) A465 Hex Nuts, (1) A466 Lockwasher and (1) A482 Anti-rotate Ring.
Note: Switches with non-threaded bushings or bezels supplied without hardware.

QUICK-CONNECT RECEPTACLES that are compatible with solder lug or p.c. terminals are commercially available - consult factory.

FRONT PANEL SEAL: Silicone rubber boots for front panel sealing of the switch against high pressure water or other contaminants are available - see Waterproof switch sealing boots section of catalog.

TYPICAL SWITCH CROSS SECTIONS

Note: Contacts make opposite actuator direction.

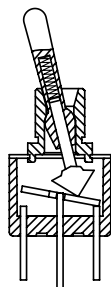

ON NONE ON

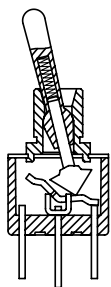

ON OFF ON

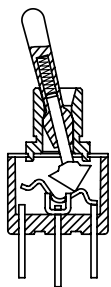

MOM OFF MOM

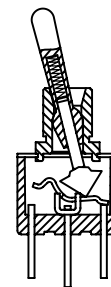

ON OFF MOM

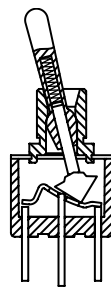

ON NONE MOM

SPECIFICATIONS SUBJECT TO CHANGE WITHOUT NOTICE

ST SERIES - MINIATURE TOGGLE SWITCHES

Additional ordering information: Commonly ordered models are shown on prior pages with complete model numbers and specifications. Below is an order format that enables you to 'build your own switch' and specify the correct switch model number by simply selecting from all available options shown and filling in the boxes.

'BUILD YOUR OWN SWITCH' ORDER FORMAT

Fill in boxes with selections shown for **Model Structure**, then add **Options** selections for complete model number.

Allowable options are shown below each respective box with brief description - see option dwgs. & info. following.

Note: 'NONE' indicates box may be left empty.

Model Structure:

Series	Electrical functions	Actuators	Bushings	Terminations	Contact material
<input type="text"/>	<input type="text"/>	<input type="text"/>	<input type="text"/>	<input type="text"/>	<input type="text"/>
Single pole: S T 1 -	1 ON NONE ON 2 ON OFF ON	K Standard bat F 1 Flatted	M Standard 1/4" thd'd. D 'D' flat 1/4" thd'd.	Z Solder lug C Printed circuit	B Gold Q Coin silver
S.P. UL model: U L 1	4 ON OFF MOM Following for DP only	F 2 Long flatted F 3 Short flatted	H Splashproof 1/4" thd'd. Y Long 1/4" thd'd.	W Wirewrap W 1 Lg. wirewrap	G Gold/coin silver
Double pole: S T 2 -	6 ON ON ON 7 ON ON MOM	L Long round L 1 Medium rnd.	S 2 Non-threaded S 3 Short non-thd'd.	W 3 Sht. wirewrap X Extra lg. wirewrap	N Economy gold
D.P. UL model: U L 2	8 MOM ON MOM	L 2 Short round L 3 Short round	M 4 15/32" thd'd. M 5 M4 with 'o'-ring	Horiz. right angle p.c. terminals: A A - 1 Vertical right angle p.c. terminals: V V - 1 V - 2 Straight p.c. terminals w/brkt.: V 3 0 V 4 0	T Economy silver

Note: When switch is ordered with a bezel, actuator selection may be **K, L, L1, or L2** and bushing must be **M** only.

Options:

Sealing	Colored actuator*	Colored bushing*	Bezel & Insert	Bezel color	Insert color	Approvals
<input type="text"/>	<input type="text"/>	<input type="text"/>	<input type="text"/>	<input type="text"/>	<input type="text"/>	<input type="text"/>
(NONE) E Epoxy	(NONE) 2 Black	(NONE) 2 Black	(NONE) J 6 1 Snap-in w/LED J 9 0 Snap-in no LED J 9 1 Snap-in w/LED J 9 2 Snap-in w/2 LEDs J 9 3 p.c. no LED J 9 4 p.c. w/LED J 9 5 p.c. w/2 LEDs Self-keying round hole mt.: J 9 6 Snap-in no LED J 9 7 Snap-in w/LED J 9 8 Snap-in w/2 LEDs	(NONE) 2 Black 6 Red 8 White	(NONE) 2 Black 6 Red 8 White	(NONE) / C S A

Example of completely specified model number:
UL15KMZQEJ9726/CSA

**SWITCH BODY
SIZES WITH
TERMINAL
LOCATION
DIMENSIONS**

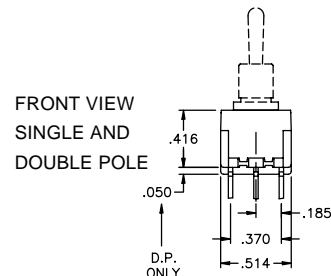
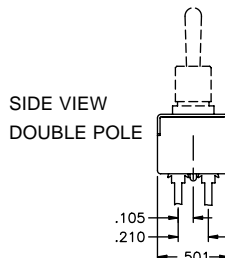
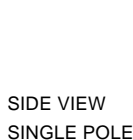

SPECIFICATIONS SUBJECT TO CHANGE WITHOUT NOTICE

ST SERIES - MINIATURE TOGGLE SWITCHES

K

SPECIFICATIONS SUBJECT TO CHANGE WITHOUT NOTICE

ACTUATOR OPTIONS

<p>L</p> <p>LONG ROUND</p>	<p>F1</p> <p>FLATTED</p>	<p>F2</p> <p>LONG FLATTED</p>	<p>F3</p> <p>SHORT FLATTED</p>	<p>K (STANDARD)</p> <p>ROUND</p>
<p>L1</p> <p>MEDIUM ROUND</p>	<p>L2</p> <p>SHORT ROUND</p>	<p>L3</p> <p>SHORT ROUND</p>	<p>T1 & T2 (FOR M4 & M5 BUSHINGS ONLY)</p> <p>LONG & SHORT ROUND</p>	<p>T3 & T4</p> <p>Same as T1 & T2 respectively except with positive internal keying and sideways support to provide more ruggedness in harsh applications.</p> <p>Available only with M4 bushing</p>

BUSHING OPTIONS

<p>D</p> <p>THREADED</p>	<p>H</p> <p>SPLASHPROOF</p>	<p>SEALS</p>	<p>M (STANDARD)</p> <p>THREADED</p>	<p>Y</p> <p>LONG THREADED</p>
<p>S2</p> <p>NON THREADED</p>	<p>S3</p> <p>NON THREADED</p>	<p>M4 & M5</p> <p>THREADED</p>	<p>M5 FEATURES 'O'-RING FOR SPLASHPROOF APPLICATIONS</p>	

ACTUATOR & BUSHING COMPATIBILITY TABLE WITH DIMENSIONS FOR SELECTIONS

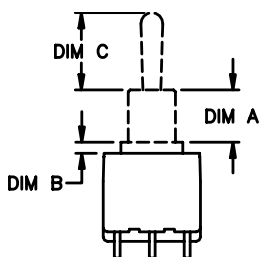

Bushing Option	Bushing Dims.		Actuator length dimension C									
	Dim A	Dim B	F1	F2	F3	K	L	L1	L2	L3	T1	T2
D	.277	.060	N/A	N/A	N/A	.410	.840	.640	.270	.170	N/A	N/A
H	.290	.060	N/A	N/A	N/A	.410	.840	.640	.270	.170	N/A	N/A
M	.277	.060	.450	.650	.250	.410	.840	.640	.270	.170	N/A	N/A
Y	.330	.040	N/A	N/A	N/A	.410	.840	.640	.270	.170	N/A	N/A
S2	.277	.060	.450	.650	.250	.410	.840	.640	.270	.170	N/A	N/A
S3	.177	.060	N/A	N/A	N/A	.510	.940	.740	.370	.270	N/A	N/A
M4	.448	-	N/A	N/A	N/A	N/A	N/A	N/A	N/A	N/A	.460	.687
M5	.448	-	N/A	N/A	N/A	N/A	N/A	N/A	N/A	N/A	.460	.687

N/A - NOT AVAILABLE

CONSULT FACTORY FOR SPECIAL REQUIREMENTS

ST SERIES - MINIATURE TOGGLE SWITCHES

TERMINATION OPTIONS

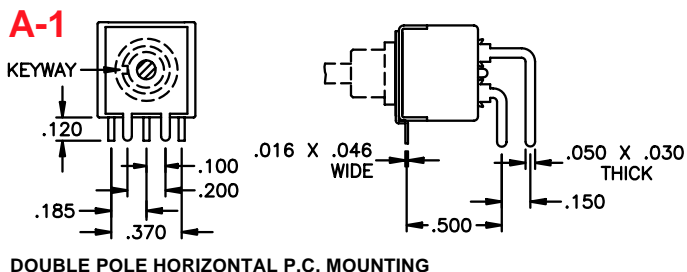
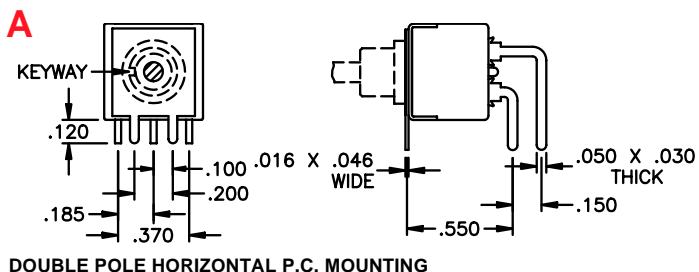
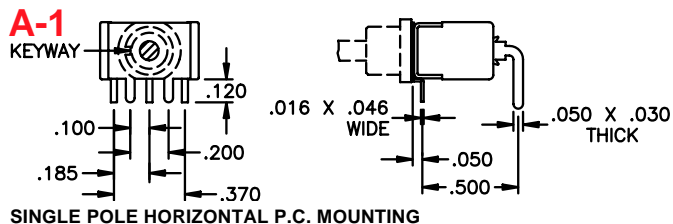
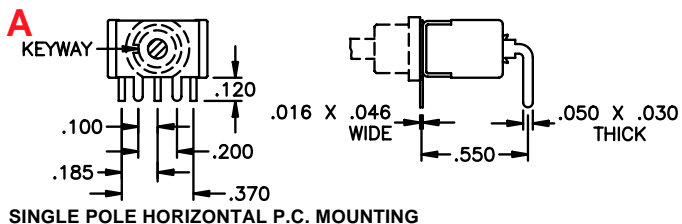

V, V-1 & V-2

FRONT VIEW SINGLE POLE

FRONT VIEW DOUBLE POLE

SIDE VIEW - SINGLE & DOUBLE POLE

Option	Dim. A	Dim. B
V	.550	.150
V-1	.500	.150
V-2	.500	.100

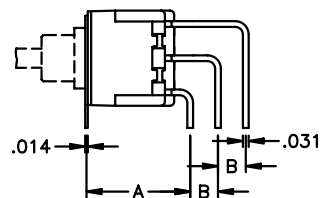
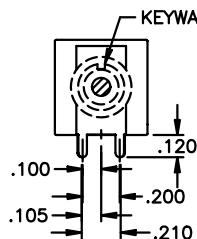
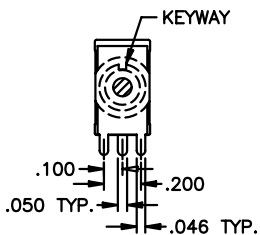

VERTICAL P.C. MOUNTING

V30 & V40

PANEL LAYOUT V30, V31, V40 & V41

Option	Dim. A	Dim. B
V30	.527	.024
V40	.647	.048

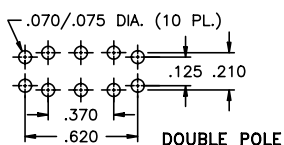
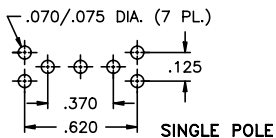

FRONT VIEW SINGLE POLE

FRONT VIEW DOUBLE POLE

SIDE VIEW - SINGLE AND DOUBLE POLE

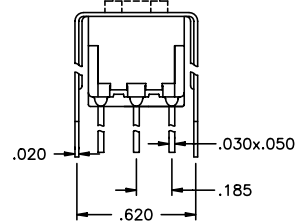
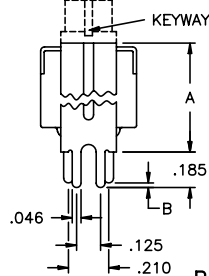
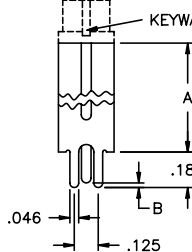

PRINTED CIRCUIT MOUNTING

SPECIFICATIONS SUBJECT TO CHANGE WITHOUT NOTICE

ST SERIES - MINIATURE TOGGLE SWITCHES

K

TERMINATION OPTIONS (CONT'D.)

Z

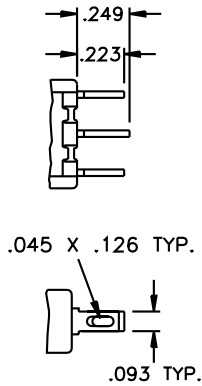

SOLDER LUG

C

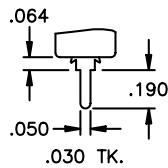

PRINTED CIRCUIT

W

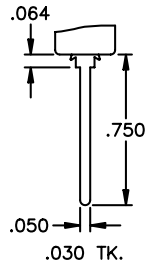

WIREWRAP

W1

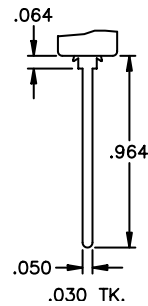

LONG WIREWRAP

W3

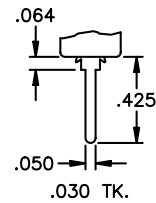

SHORT WIREWRAP

X

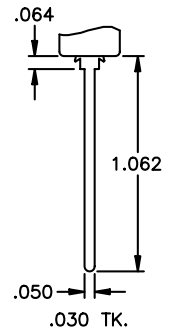

EXTRA LG. WIREWRAP

CONTACT MATERIAL OPTIONS

B

Dry circuit - gold over nickel over brass.
RATING: 0.4 Volt-Amps (VA) max. at 20 V max.
ELECTRIC LIFE: 100,000 cycles min. (ST1-1 & ST2-1 only - other models 40,000 cycles min.)

Q

Power circuit - coin silver.
RATING: 6 Amps at 125 VAC, 3 Amps at 250 VAC or 7 Amps at 30 VDC (resistive loads).
ELECTRIC LIFE: 100,000 cycles min. (ST1-1 & ST2-1 only - other models 40,000 cycles min.)

G

Dry circuit or power circuit - gold over nickel over coin silver.
RATINGS & ELECTRIC LIFE: Same as B & Q above - i.e. - can be used in either dry circuit or power circuit, however once used in power circuit, switch cannot be re-used in dry circuit. This option satisfies those customers who have both dry circuit and power circuit requirements, but prefer to inventory only one switch for both.

N

Dry circuit - gold over nickel over brass. Note- less gold than B option.
RATING: 0.4 Volt-Amps (VA) max. at 20 V max.
ELECTRIC LIFE: 10,000 cycles min. at 13 cycles per minute.

T

Power circuit - Silver plate over brass.
RATING: 3 Amps at 125 VAC or 1.5 Amps at 250 VAC (resistive loads).
ELECTRIC LIFE: 10,000 cycles min. at 13 cycles per minute.

Solder dipped terminals and custom contact plating available - contact factory.

UL & CSA OPTIONS

UL

For power circuits - coin silver
RATING: 6 Amps at 125 VAC or 3 Amps at 250 VAC (75% power factor).
Underwriter Laboratories file no. E66367. To specify, order UL model no. Note - applicable only to terminations with coin silver contacts (Q or G options).

CSA

For power circuits - coin silver
RATING: 6 Amps at 125 VAC or 3 Amps at 250 VAC (75% power factor). Canadian Standards Association file no. LR54592-1. To specify, UL model number, then add '/CSA' to complete switch number. Note - applicable only to terminations with coin silver contacts (Q or G options) as CSA recognizes switches for power applications only.

SEALING & MISCELLANEOUS OPTIONS

E

Epoxy terminal sealing: Available with all terminal configurations.

The space between terminal & case hole is sealed with epoxy all around terminal.

Provides maximum protection from entry of flux or contaminants into the switch case.

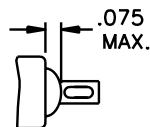

/R

To specify reverse switch action on non-symmetrical models with bushing keyway, add '/R' to switch model no.

22

Black finish is available on actuator, bushing & hardware. To specify, add '-22' to switch model no.

SPECIFICATIONS SUBJECT TO CHANGE WITHOUT NOTICE

ST SERIES - MINIATURE TOGGLE SWITCHES

PANEL CUT-OUTS

Cut-outs that accept all 1/4-40 threaded bushings:

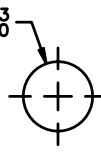
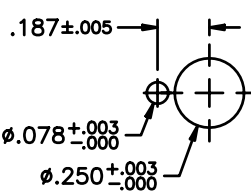
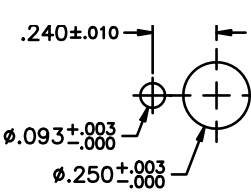
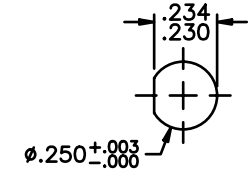
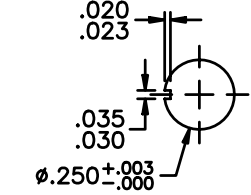
 <p>Without keying</p>	 <p>With A107 anti-rotate ring</p>	 <p>With A158 anti-rotate ring</p>	 <p>With D bushing</p>	 <p>With slotted keyway bushings</p>
---	---	---	--	---

Cut-outs that accept non-threaded 1/4" bushings and 15/32" threaded bushings:

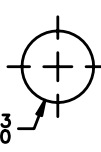
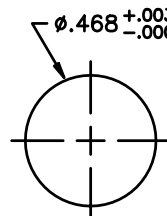
 <p>Accepts all non-threaded 1/4" bushings</p>	 <p>15/32" threaded bushings</p>
---	---

SPECIFICATIONS SUBJECT TO CHANGE WITHOUT NOTICE