

KEMET, SSRH7HS-M, AC Line Filters, Common Mode, 0.0925 H

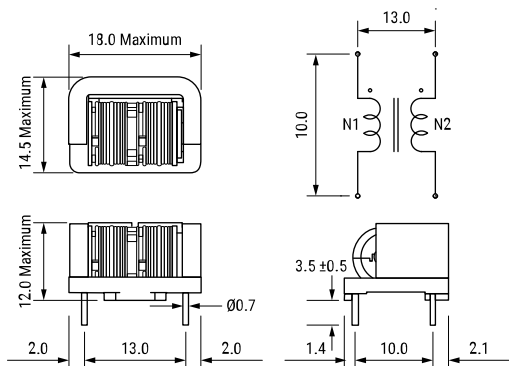

Dimensions

L	18mm MAX
T	14.5mm MAX
H	12mm MAX
LL	3.5mm +/-0.5mm
S	10mm NOM

Packaging Specifications

Packaging:	Tray
Packaging Quantity:	600
Weight:	5.1 g

General Information

Series:	SSRH7HS-M
Style:	Through-Hole
RoHS:	Yes
Notes:	M03 Lot No.
Miscellaneous:	Temperature Rise Maximum: 50 K

Specifications

Voltage AC:	250 VAC
Inductance:	92.5 mH (10 kHz)
Current:	300 mA
Temperature Range:	-25/+120C
DC Resistance:	3.18 Ohms