

Features

- Wirewound construction
- Iron powder core
- Magnetically shielded construction provides low radiation
- Low DC resistance
- Low profile
- RoHS compliant*

Applications

- DC/DC converters for:
 - Smart phones
 - DVC/DSCs
 - Tablets
 - HDD/SSDs
 - Mobile electronic devices

SRP2010 Series - SMD Power Inductors

Electrical Specifications @ 25 °C

Bourns Part Number	Inductance @ 1 MHz / 1 V		DCR (mΩ) Max.	I _{rms} (A)	I _{sat} (A)
	L (μH)	Tol. (%)			
SRP2010-R24M	0.24	20	21	4.5	5.6
SRP2010-R33M	0.33	20	29	3.8	5.0
SRP2010-R47M	0.47	20	40	3.3	4.4
SRP2010-R68M	0.68	20	49	3.1	3.7
SRP2010-1R0M	1.0	20	69	2.6	2.9
SRP2010-1R5M	1.5	20	137	1.9	2.5
SRP2010-2R2M	2.2	20	150	1.7	1.9

How to Order

SRP2010 - 1R0M

Model _____
Value Code (see table) _____

Electrical Schematic

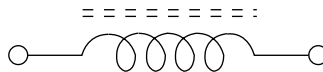

Soldering Profile

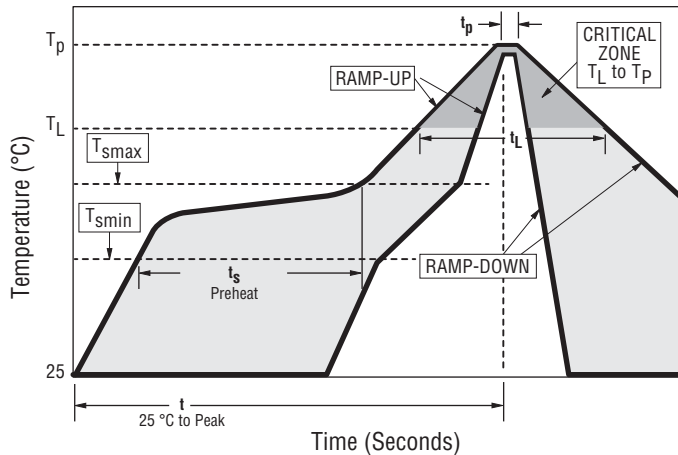

Profile Feature	Pb Free Assembly
Average Ramp Rate (T _{Smax} to T _P)	3 °C/second max.
Preheat	
- Temperature Min. (T _{Smin})	150 °C
- Temperature Max. (T _{Smax})	200 °C
- Time (t _{Smin} to t _{Smax})	60-180 seconds
Time Maintained Above	
- Temperature (T _L)	217 °C
- Time (t _L)	60-150 seconds
Peak Temperature (T _P)	260 °C +0/-5 °C
Time within 5 °C of Actual Peak Temperature (T _P)	20-40 seconds
Ramp-Down Rate	6 °C/second max.
Time 25 °C to Peak Temperature	8 minutes max.

General Specifications

Inductance Test Frequency/
Voltage 1 MHz/1 V
Operating Temperature
.....-40 °C to +125 °C
(Temperature rise included)
Storage Temperature
.....-50 °C to +125 °C
Rated Current
..... Inductance drops 30 % at I_{sat}
Temperature Rise40 °C at rated I_{rms}
Resistance to Soldering Heat.....+260 °C

Materials

Core..... Iron powder
Terminal..... Ni/Sn
Packaging..... 3000 pcs. per 7-inch reel

Product Dimensions

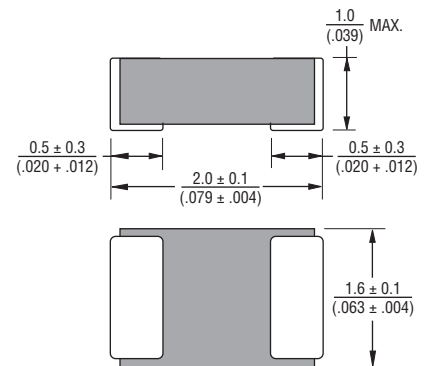

Recommended Layout

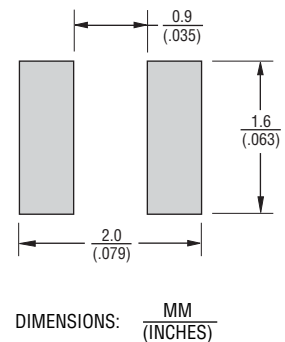

* RoHS Directive 2002/95/EC Jan. 27, 2003 including annex and RoHS Recast 2011/65/EU June 8, 2011. Specifications are subject to change without notice.

The device characteristics and parameters in this data sheet can and do vary in different applications and actual device performance may vary over time. Users should verify actual device performance in their specific applications.

SRP2010 Series - SMD Power Inductors



L vs. I Charts

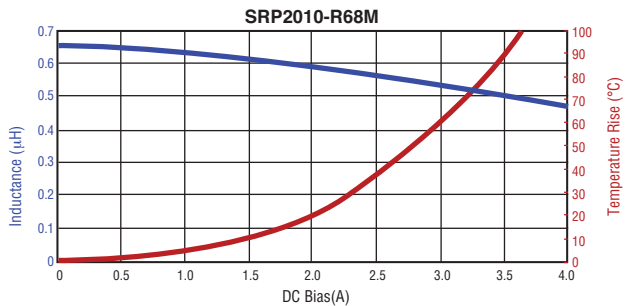
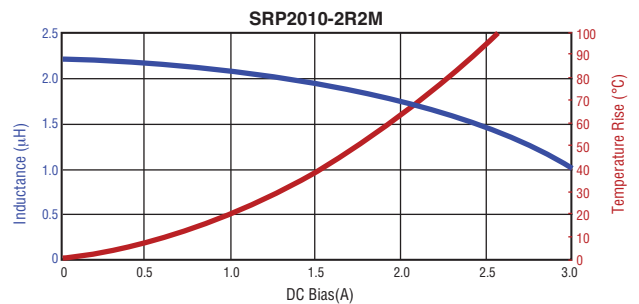
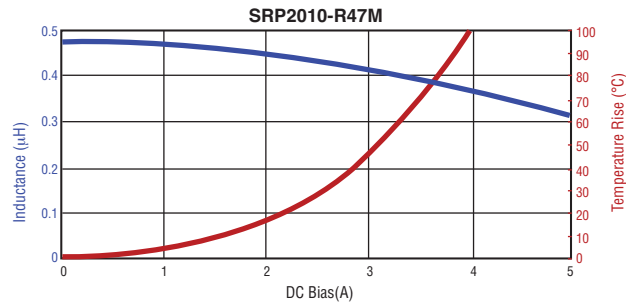
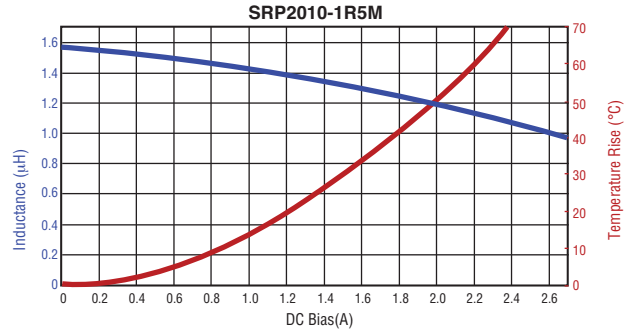
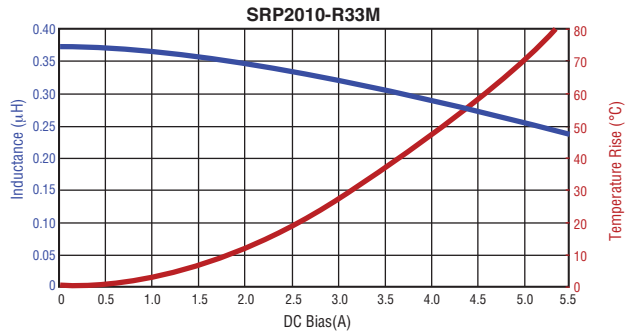
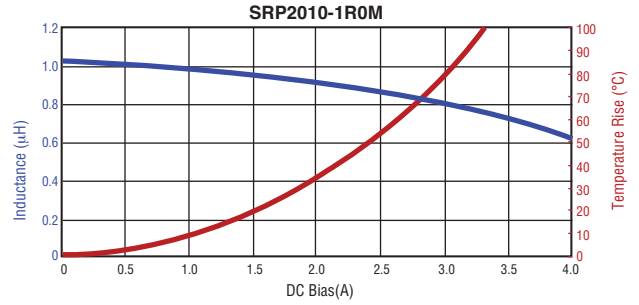
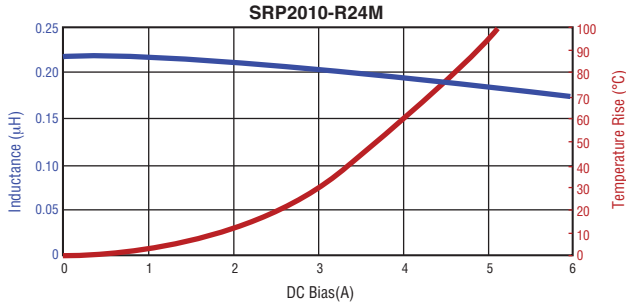

Specifications are subject to change without notice. The device characteristics and parameters in this data sheet can and do vary in different applications and actual device performance may vary over time. Users should verify actual device performance in their specific applications.

SRP2010 Series - SMD Power Inductors

BOURNS®

Packaging Specifications

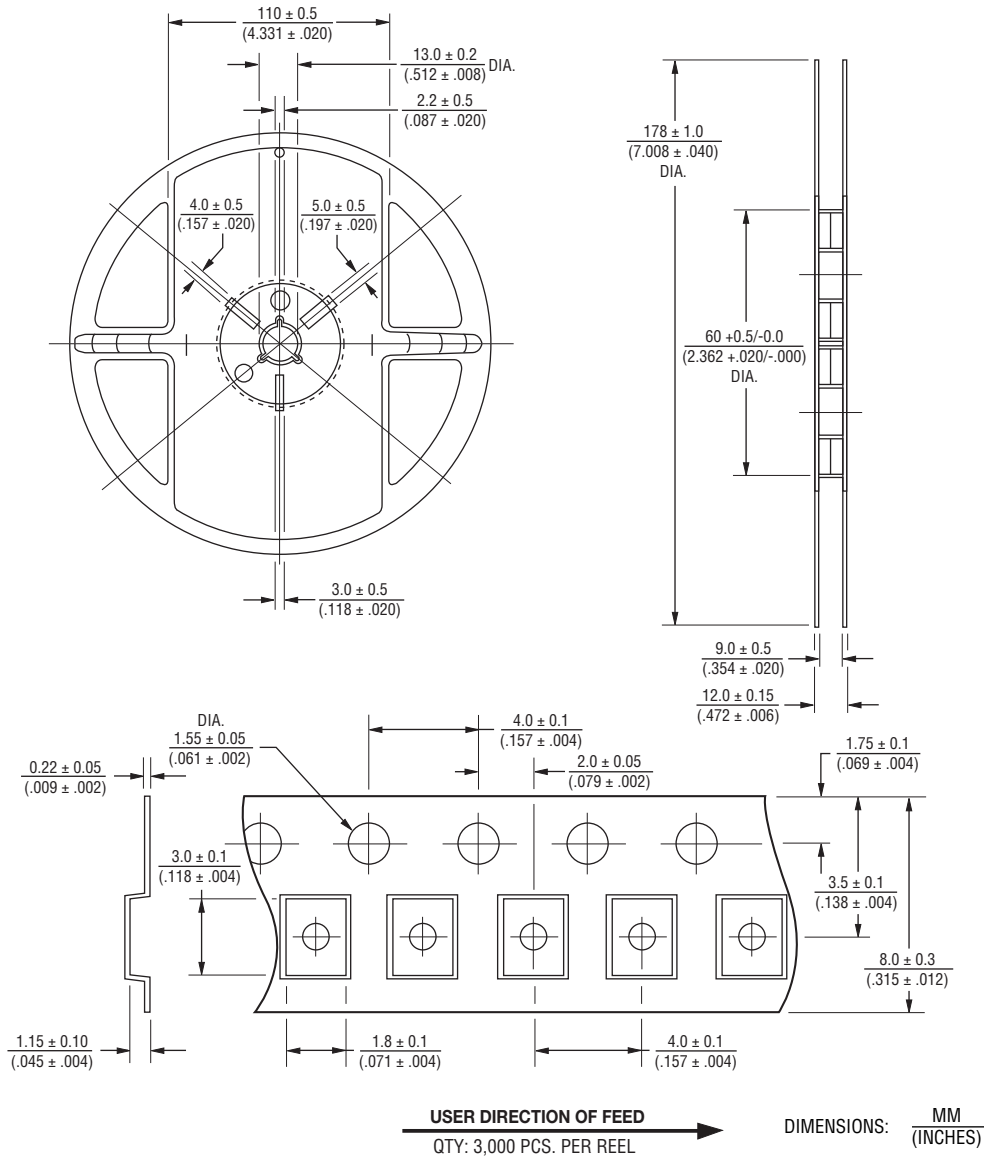

BOURNS®

Asia-Pacific: Tel: +886-2 2562-4117 • Fax: +886-2 2562-4116

EMEA: Tel: +36 88 520 390 • Fax: +36 88 520 211

The Americas: Tel: +1-951 781-5500 • Fax: +1-951 781-5700

www.bourns.com

REV. 02/15

Specifications are subject to change without notice.

The device characteristics and parameters in this data sheet can and do vary in different applications and actual device performance may vary over time. Users should verify actual device performance in their specific applications.