

## Features

- Bifilar wound
- High common mode impedance
- RoHS compliant\* and halogen free\*\*

## Applications

- EMI suppression for:
  - Data and signal lines
  - Telecom devices
  - Consumer electronics

# SRF4532 Series - Common Mode Chip Inductors

### Electrical Specifications

Part Number	Inductance (μH) @ 100 KHz Common Mode	Tolerance (%)	Impedance (Ω) @ 10 MHz Common Mode		DCR Max. (Ω)	IDC Max. (mA)
			Min.	Typ.		
SRF4532-1R0Y	1	+50 / -30	60	68	0.12	1200
SRF4532-110Y	11	+50 / -30	300	700	0.8	300
SRF4532-220Y	22	+50 / -30	500	1000	2.65	200
SRF4532-510Y	51	+50 / -30	1000	2000	3.5	200
SRF4532-101Y	100	+50 / -30	2000	5000	8.9	200

### Soldering Profile

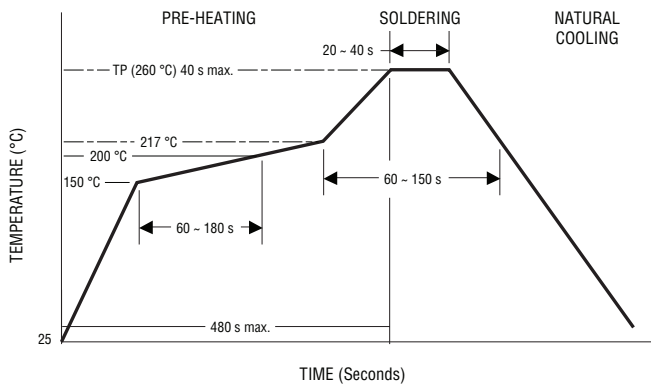

### General Specifications

Rated Voltage ..... 50 VDC  
 Withstanding Voltage ..... 125 VDC  
 Insulation Resistance ..... 10 megohms min. @ 100 VDC  
 Operating Temperature... -40 °C to +125 °C  
 (Temperature rise included)  
 Storage Temperature..... -40 °C to +125 °C  
 Resistance to Soldering Heat ..... +260 °C, 40 sec. max.  
 Temperature Rise  
 SRF4532-1R0Y ..... 40 °C at rated IDC  
 SRF4532-110Y  
 to -101Y ..... 30 °C at rated IDC  
 Moisture Sensitivity Level ..... 1  
 ESD Classification (HBM) ..... N/A

### Materials

Core ..... Ferrite  
 Wire ..... Enamelled copper  
 Terminal ..... Sn  
 Packaging ..... 500 pcs. per 7-inch reel

### Product Dimensions

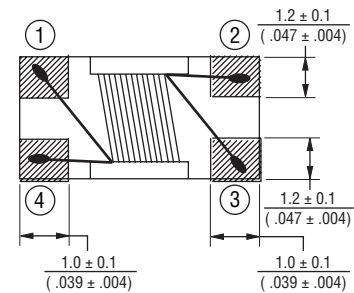
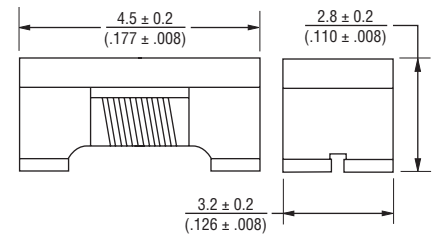

DIMENSIONS:  $\frac{\text{MM}}{\text{(INCHES)}}$

### How to Order

**SRF4532 - 220 Y**

Model \_\_\_\_\_  
 Value Code (see table) \_\_\_\_\_  
 Tolerance Code \_\_\_\_\_

### Schematic

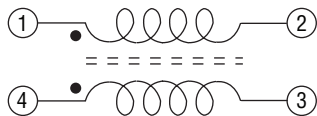

### Recommended Layout

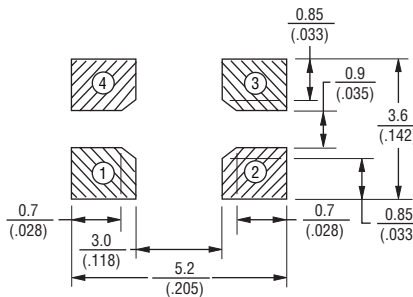

\* RoHS Directive 2002/95/EC Jan. 27, 2003 including annex and RoHS Recast 2011/65/EU June 8, 2011.

\*\* Bourns follows the prevailing definition of "halogen free" in the industry. Bourns considers a product to be "halogen free" if (a) the Bromine (Br ) content is 900 ppm or less; (b) the Chlorine ( Cl ) content is 900 ppm or less; and (c) the total Bromine (Br ) and Chlorine ( Cl ) content is 1500 ppm or less.

Specifications are subject to change without notice.

The device characteristics and parameters in this data sheet can and do vary in different applications and actual device performance may vary over time.

Users should verify actual device performance in their specific applications.

# SRF4532 Series - Common Mode Chip Inductors

**BOURNS®**

## Typical Impedance vs. Frequency Curves

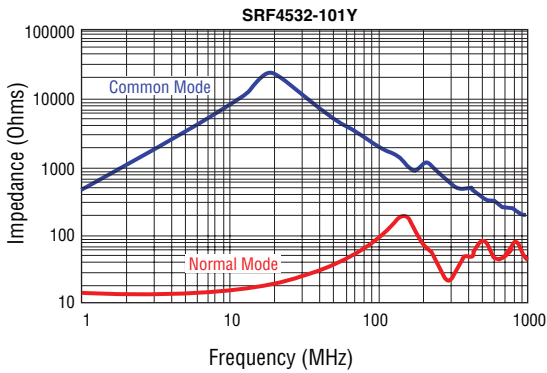
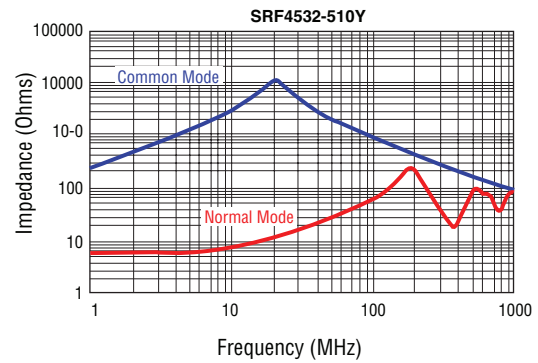
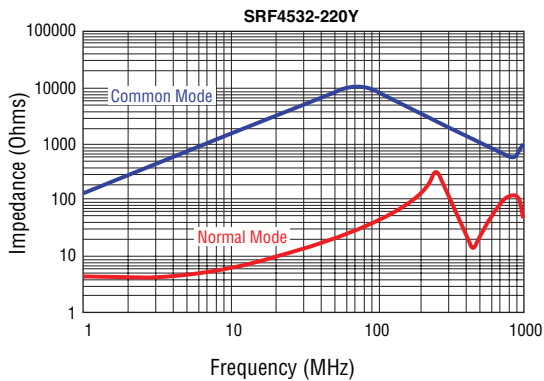
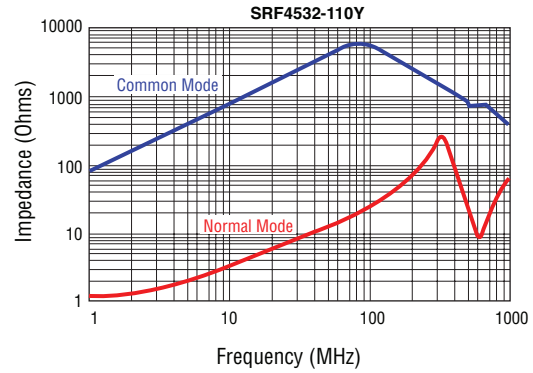
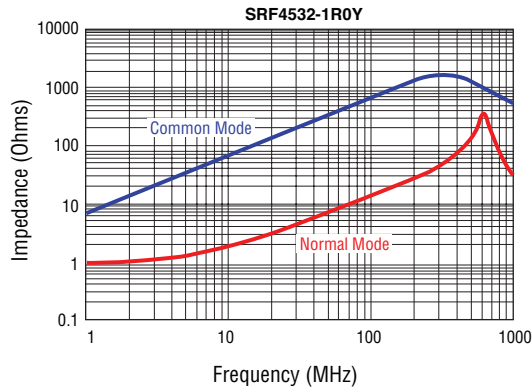

Specifications are subject to change without notice.  
 The device characteristics and parameters in this data sheet can and do vary in different applications and actual device performance may vary over time.  
 Users should verify actual device performance in their specific applications.

# SRF4532 Series - Common Mode Chip Inductors

**BOURNS®**

## Packaging Specifications

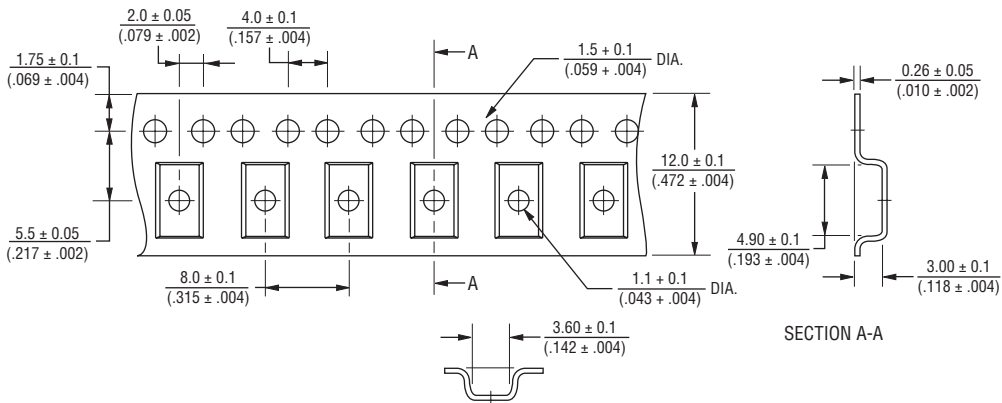
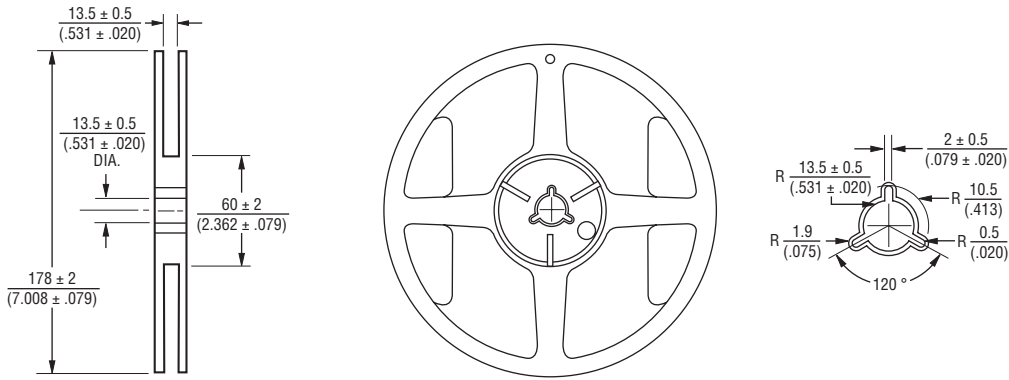

USER DIRECTION OF FEED →  
QTY: 500 PCS. PER REEL

DIMENSIONS:  $\frac{\text{MM}}{\text{(INCHES)}}$

REV. 03/18

Specifications are subject to change without notice.  
The device characteristics and parameters in this data sheet can and do vary in different applications and actual device performance may vary over time.  
Users should verify actual device performance in their specific applications.