

# SP series

## Washable snap-action pushbutton switches

*Distinctive features and specifications*

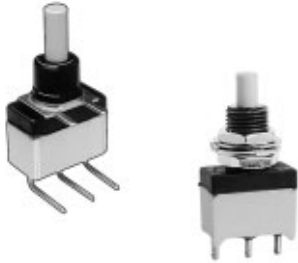

### Sealed

- Secure assembly of the two case parts
- Internally sealed bushing
- Epoxy sealed terminals

### Process compatible (plain bushing models)

- Wave solderable
- Washable

### ELECTRICAL SPECIFICATIONS

- Max. current/voltage rating with resistive load :
  - gold plated brass contacts : 100mA 30VDC
  - silver or gold plated silver contacts : 1A 120VAC - 1A 30VDC
- Initial contact resistance : 50 mΩ max.
- Insulation resistance : 1.000 MΩ min.
- Dielectric strength : 1.000 Vrms 50 Hz min.
- Electrical life : 60.000 cycles

### MATERIALS

- Case and cover : UL94-V0, polyamide, glass filled or PES
- Actuator : polyamide, glass filled
- Contacts
  - 0 : brass, gold plated
  - 1 : silver
  - 2 : silver, gold plated
- Terminal seal : epoxy

### GENERAL SPECIFICATIONS

- Torque : 0,25 Nm (.18 Ft.lb) applied to nut (threaded bushing)
- Total travel : 0,50 mm (.019)
- Mechanical strength :  
Terminals are strengthened by a bracket or a ground plate ensuring the rigidity of the switch on the board. Actuator strength is 10N max.
- Operating temperature : -20°C to +85°C
- Storage temperature : -40°C to +85°C
- Moisture :  
The insulating materials employed and the complete seal permit the switches to withstand a 56 days moisture test (IEC 68-2-3).
- Soldering - thermal shock (plain bushing models only) :  
The switches are especially designed for flow soldering at 260°C during 5 seconds owing to high temperature polymer parts.
- Iron soldering (threaded bushing models) : 300°C max., 5 seconds max.
- Solderability : The switches are tested at 235°C according to IEC 68-2-20 after accelerated aging.

### AGENCY APPROVAL



**Availability** : all models with silver or gold plated silver contacts.

**Marking** : to order switches marked UL, complete appropriate box of ordering format.

# SP series

## Washable snap-action pushbutton switches

Overview

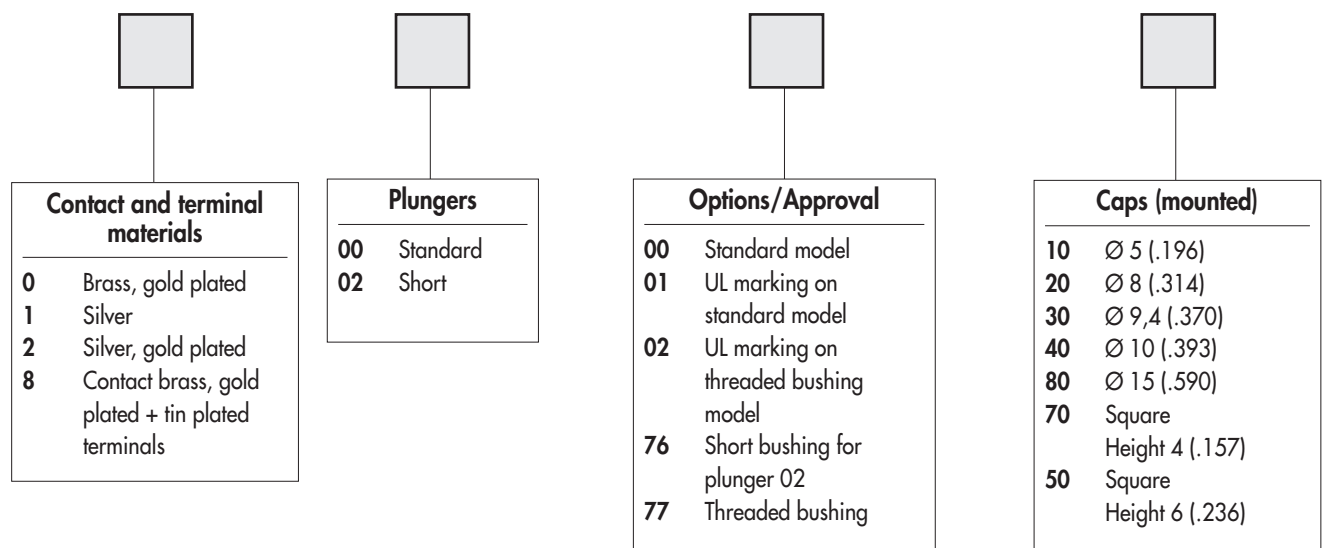
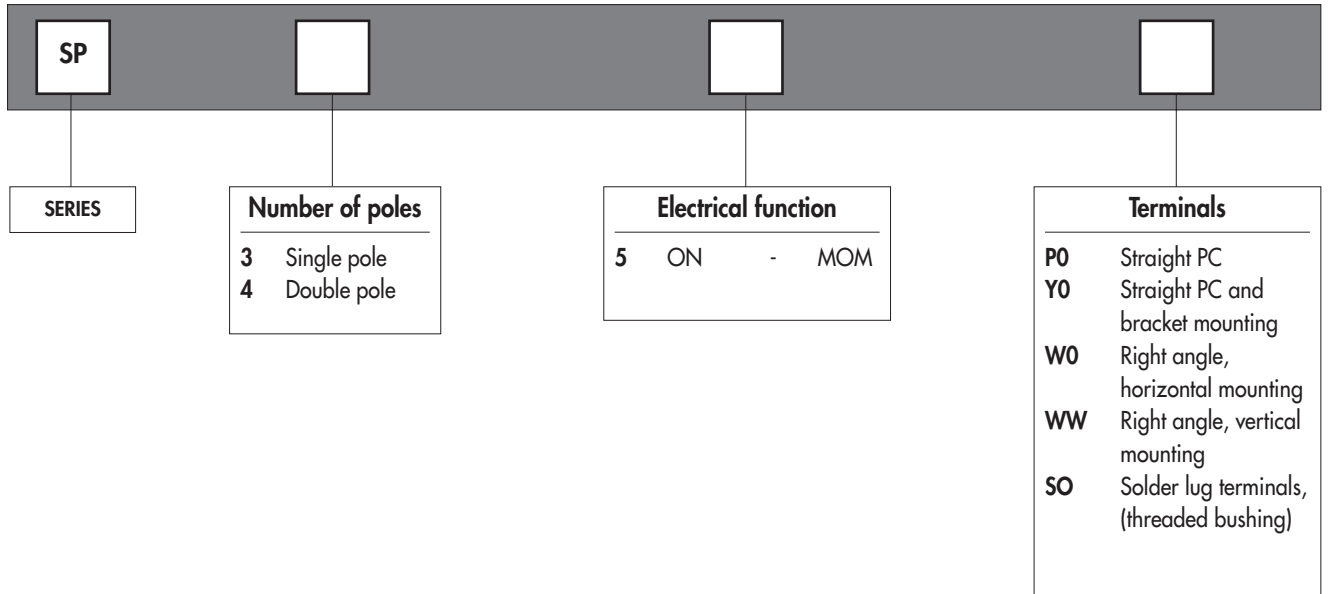

### ABOUT THIS SERIES

On the following pages, you will find successively :

- model structure of switches
- options in the same order as above

Specifications are on previous page.

**Dimensions** : first dimensions are in mm while inches are shown as bracketted numbers.



**Mounting accessories** : standard hardware supplied with all models with Ø 6,35 (1/4) threaded bushing :

2 hex nuts 8 mm (.314) across flats, 1 locking ring and 1 lockwasher.  
Standard and special hardware available are presented in section I.



**Packaging unit** : 25 or 50 pieces depending on model.

# SP series

## Washable snap-action pushbutton switches

Plain or threaded bushing

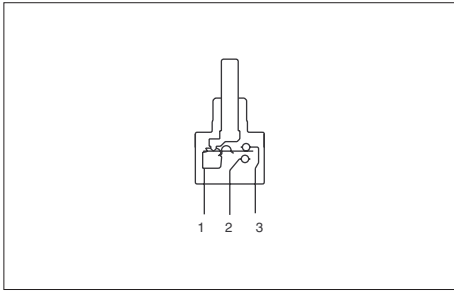

- Solder lug, straight PC or right angle terminals
- Features of threaded bushing models :
  - max. torque : 0,25 Nm (.18 Ft.lb)
  - iron soldering : 300°C max., 5 seconds max.
- 1 and 2 pole configurations

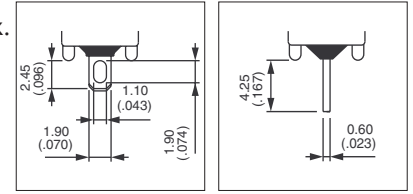

MODEL STRUCTURE

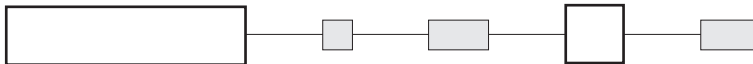

Shown with standard plunger

### Plain bushing - straight PC terminals



Single pole

SP35P0... 00

Double pole

SP45P0... 00

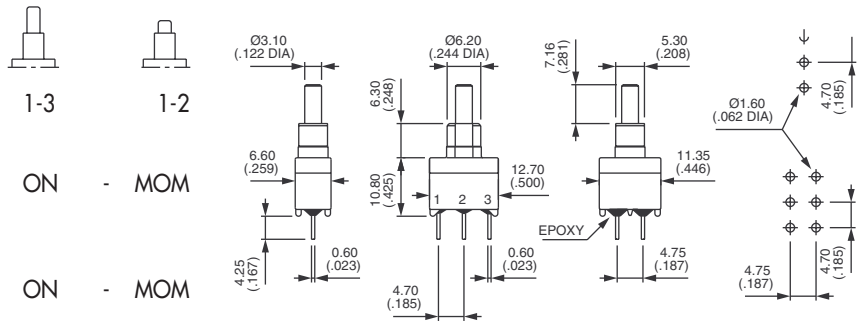

### Plain bushing - bracket mounting



Single pole

SP35Y0... 00

Double pole

SP45Y0... 00

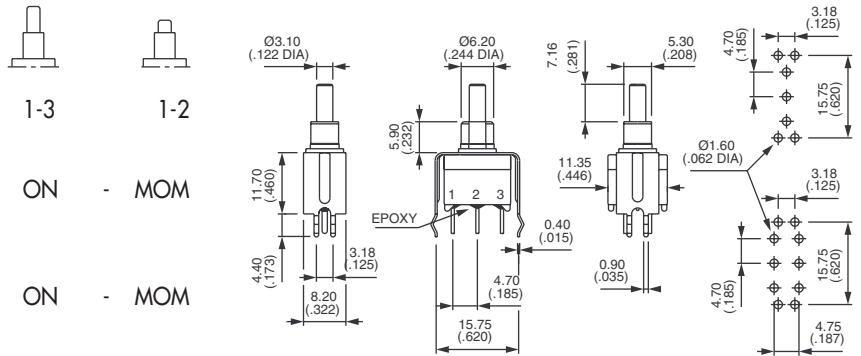

### Plain bushing - right angle terminals - horizontal



Single pole

SP35W0... 00

Double pole

SP45W0... 00

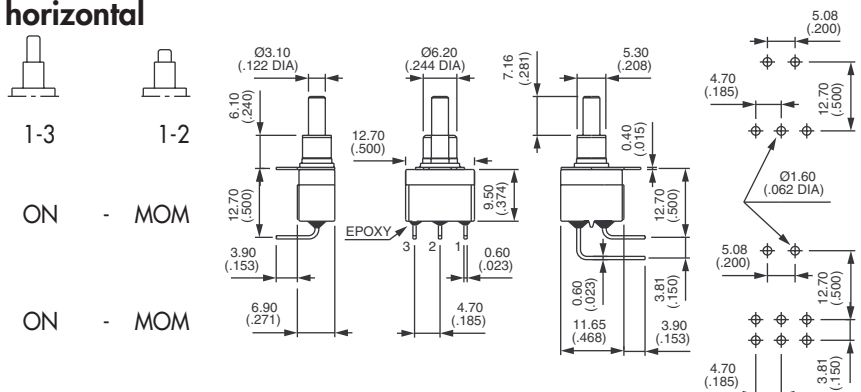



# SP series

## Washable snap-action pushbutton switches

Plain or threaded bushing

Shown with standard plunger

### Plain bushing - right angle terminals - vertical



Single pole

SP35WW... 00

Double pole

SP45WW... 00



1-3



1-2

ON - MOM

ON - MOM

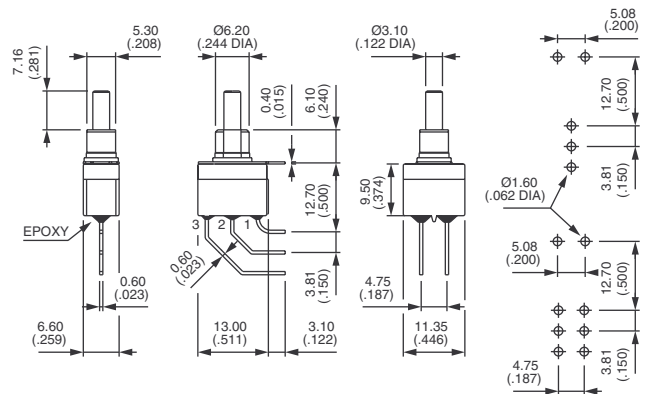

### Threaded bushing - solder lug terminals

→ Keyway



Single pole

SP35S0... 77



1-3



1-2

ON - MOM

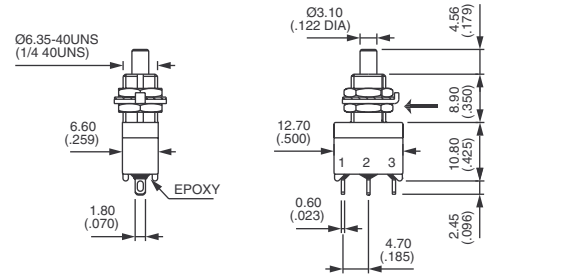

### Threaded bushing - straight PC terminals

→ Keyway



Single pole

SP35P0... 77



1-3



1-2

ON - MOM

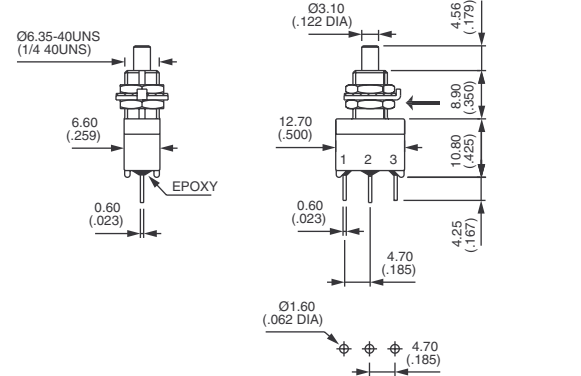

### PANEL CUT-OUT

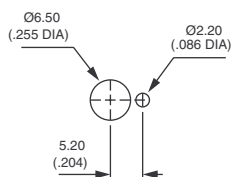

# SP series

## Washable snap-action pushbutton switches

OPTIONS



### CONTACT AND TERMINAL MATERIALS

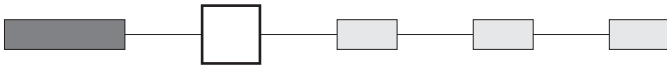

- 0 Brass, gold plated
- 1 Silver
- 2 Silver, gold plated
- 8 Contact brass, gold plated + tin plated terminals

### PLUNGERS

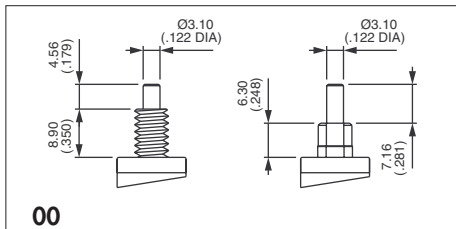

**00**  
Standard plunger

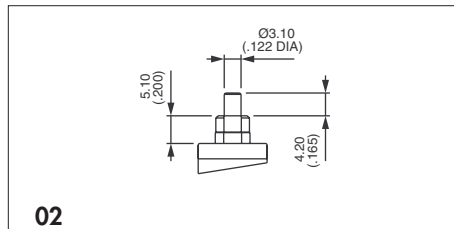

**02**  
Short (for models with plain bushing,  
single pole only)  
Order with option 76 below.

### OPTIONS / AGENCY APPROVAL

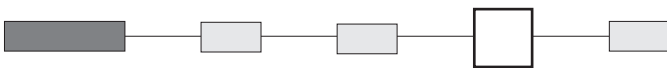

- 00 Standard model
- 01 UL marking for standard model
- 02 UL marking for threaded bushing model
- 76 Short plain bushing for 02 plunger (single pole models only)
- 77 Threaded bushing  
(included in model numbers on previous page)



# SP series

## Washable snap-action pushbutton switches

### CAPS

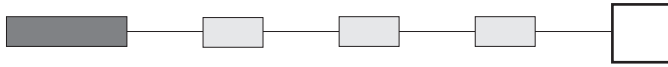

Blank Without cap

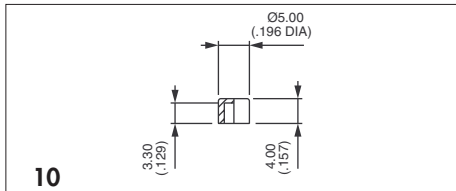

**10**  
P/N U2400

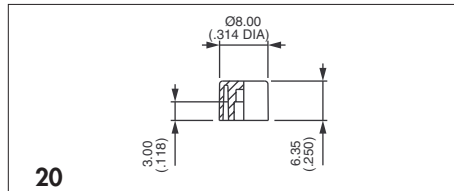

**20**  
P/N U2510

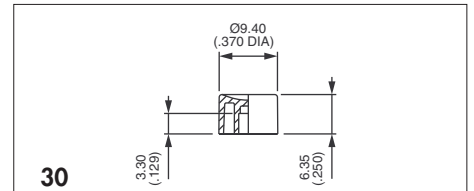

**30**  
P/N U2130

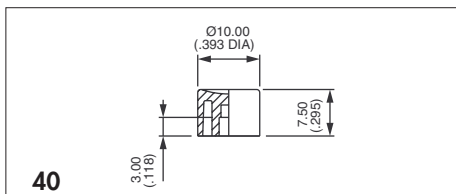

**40**  
Standard - P/N U2900

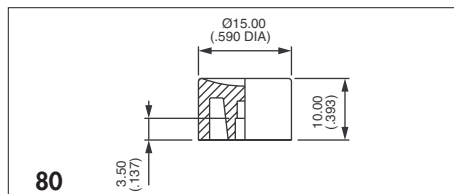

**80**  
P/N U3400  
Not available with plunger 02

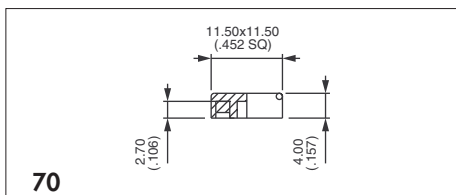

**70**  
Square - P/N U910

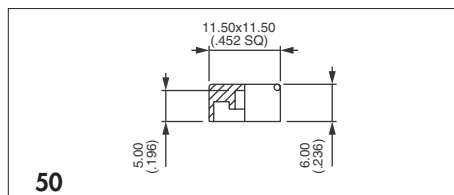

**50**  
Square - P/N U2340  
Not available with plunger 02

Cap colours	
Replace last "0" by number	
1	blue
1/4	dark blue
2	black
3	green
4	grey
5	yellow
6	red
7	ivory
7/1	white
9	orange

To order caps separately, use their P/N (U...) (for threaded bushing order only separately).

### DRESS NUTS

Chrome plated

For threaded bushing models only.

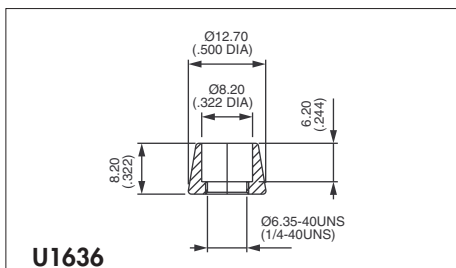

**U1636**  
For cap U2510

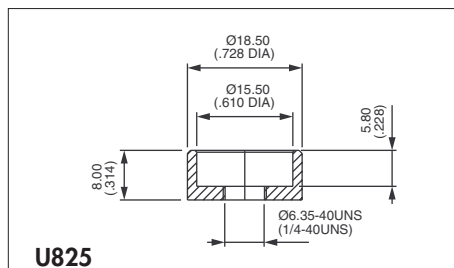

**U825**  
For cap U3400

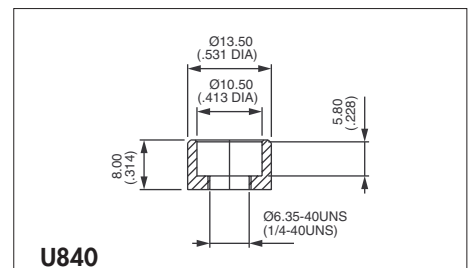

**U840**  
For cap U2900

Dress nuts are to be ordered separately.