

KEMET Part Number: SNT-D20T
(UDLSNT0D20T000)

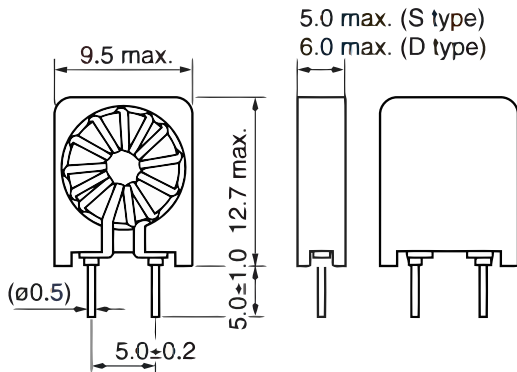

KEMET, SNT, DC Line Filters, Common Mode, 10 uH



General Information	
Series:	SNT
Style:	Through-Hole
RoHS:	Yes

Specifications	
Inductance:	10 uH
Temperature Range:	-20/+60°C
DC Resistance:	45 mOhms

Dimensions	
L	9.5mm MAX
W	6mm MAX
T	6mm MAX
H	12.7mm MAX
LL	5mm +/-1mm
S	5mm +/-0.2mm

Packaging Specifications	
Packaging:	T&R
Packaging Quantity:	1000
Component Weight:	1.3 g

Statements of suitability for certain applications are based on our knowledge of typical operating conditions for such applications, but are not intended to constitute - and we specifically disclaim - any warranty concerning suitability for a specific customer application or use. This Information is intended for use only by customers who have the requisite experience and capability to determine the correct products for their application. Any technical advice inferred from this Information or otherwise provided by us with reference to the use of our products is given gratis, and we assume no obligation or liability for the advice given or results obtained.

